





LinkSymphoKnee
CCK

Surgical Technique

CE 0482

Explanation of Pictograms			
	Manufacturer		Article number
	Material (number)		Product meets the applicable requirements, which are regulated in the EU harmonization legislation for the affixing of the CE marking.

LinkSymphoKnee



CCK

02	Overview – Workflow of Surgical Steps:
	Surgical Technique:
04	Preoperative Planning
05	Approaches
06	Pins, Pin Instruments and Sawblades
08	Reamers
10	Trial Stems
12	Tibial Preparation:
12	Intramedullary Tibial Guide Assembly
13	Intramedullary Tibial Guide Alignment
16	Tibial Resection
17	Tibial Preparation
19	Tibial Augment Preparation
20	Tibial Male Taper Connection Preparation
21	Tibial Trial Component Assembly
24	Femoral Preparation:
24	Femoral Sizing:
25	Femoral Alignment Guide Assembly
26	Femoral Alignment Guide Positioning
28	Distal Femoral Resection
29	4-in-1 Femoral Cutting Block Assembly
31	4-in-1 Femoral Cutting Block Positioning
33	Femoral 4-in-1 Resection
34	Femoral Box Preparation
36	Femoral Male Taper Connection Preparation
37	Femoral Trial Assembly
40	Trial Reduction
42	Final Preparation
43	Extraction of Femoral Trial Component
44	Patella Preparation (Patella Resurfacing)
47	Final Implantation:
47	Augment Assembly, Modular Stem Assembly
50	Implantation
50	1 Fixed Bearing Modular Tibial Component Implantation
51	2 CCK Femoral Component Implantation
52	3 CCK PE Articulating Surface Implantation
53	4 Patella Implantation
54	Functional Test
55	Appendix 1, Implant Removal
58	Appendix 2, Extraction Stem Adapter and Trial Stems
59	Appendix 3, TrabecuLink Tibial Cones Compatibility
	Implants:
60	Implants Combination Overview
62	LinkSymphoKnee Femoral Components
64	LinkSymphoKnee Tibial Components
65	LinkSymphoKnee Articulating Surfaces
67	LinkSymphoKnee Press-Fit Stems
68	LinkSymphoKnee Cemented Stems, Centralizers
69	LinkSymphoKnee Cementless Stems
71	LinkSymphoKnee Replacement Sets for Cone Adapter
72	LinkSymphoKnee Femoral Augments
75	LinkSymphoKnee Tibial Augments
76	LinkSymphoKnee Patella Components
	Instruments:
77	LinkSymphoKnee Instrument Sets: Overview
101	Additional Instruments
102	Additional Information
103	Indications/Contraindications
	Important Information

NOTE: To assist the reader of this Surgical Technique, the LinkSymphoKnee instruments used in the illustrated surgical steps are shown again at the bottom of each page (from 08 to 58).

Take care to select the correct size of the instruments according to the individual surgical case.

LinkSymphoKnee
CCK



Preoperative
Planning
(Approach)



Tibial Reaming,
IM Tibial Alignment and Resection



Tibial Preparation

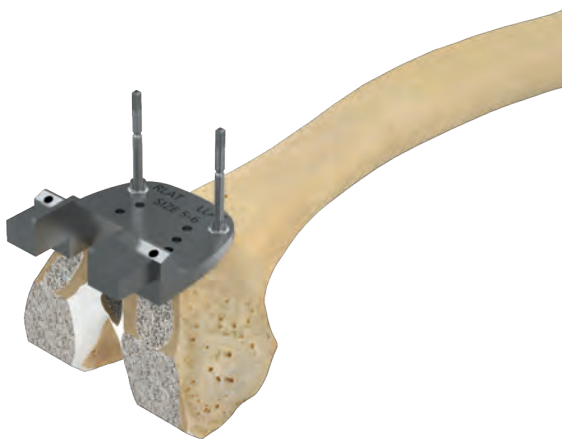

CCK Femoral Box Preparation



Trial Reduction

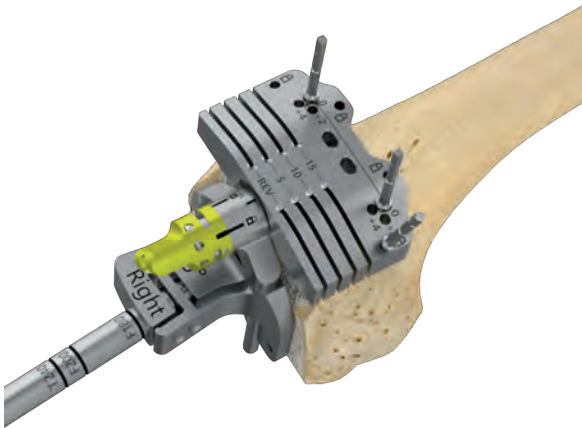

Femoral Reaming and
Distal Femoral Resection

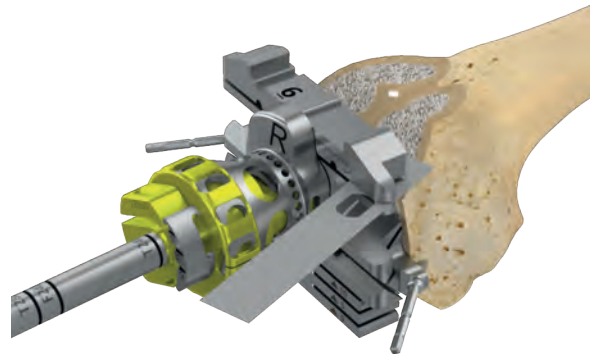

A/P Femoral
Resection and Chamfer Cuts



Final Tibial Preparation



Final Implantation

Preoperative Planning

The anatomic landmarks in the knee joint are defined preoperatively by imaging the whole leg on the healthy and the affected side in the standing position. The angle between the anatomic axis (center of knee joint – intramedullary canal) and the mechanical axis (center of femoral head – center of knee joint – center of ankle to the second toe) determines the valgus angle (01).

These angles should be determined for both knees. The valgus angle of a healthy knee joint is approximately 5°-7°. The appropriate implant size can be estimated preoperatively with X-ray templates. The necessary resections are determined by the size of the implant and the deformity corrections required.

ATTENTION: The LinkSymphoKnee CCK has an inbuilt 6° valgus angle in the femoral stem.

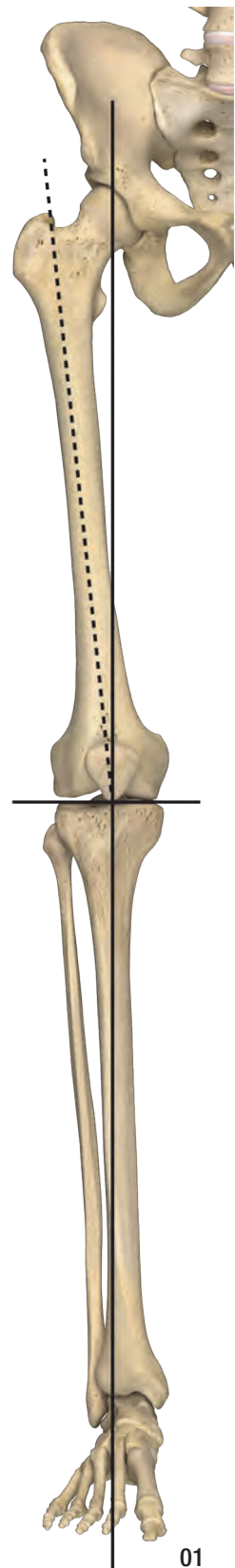

Approaches

With the knee in slight flexion, a straight incision is made over the patella, as far as the tibial tuberosity (02). A medial parapatellar incision is made through the patellar retinaculum, capsule and synovial membrane (03). When making the parapatellar incision, the patella is pushed to one side to visualize the patellofemoral joint. Removal of the hypertrophic synovial membrane and parts of the fat pad allow access to the medial, lateral and intracondylar parts of the joint. Excess synovium should be removed in order to avoid postoperative impingement and adhesions. Some surgeons prefer total synovectomy.



02



03

Component Removal

When removing the components to be revised, great care must be taken to preserve as much of the remaining bone stock as possible and to avoid the risk of fracture of the residual bone.

Bone preservation can usually be achieved through the use of small flexible osteotomes, saws and high-speed burring instruments.

Pins, Pin Instruments and Sawblades

The *LinkSymphoKnee* Instruments are designed to be used with:

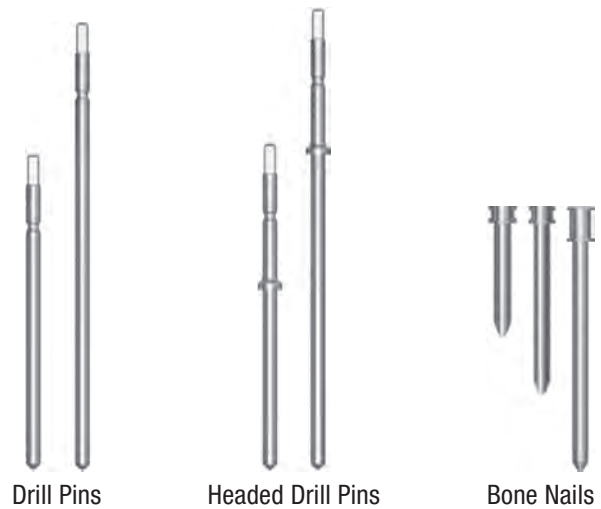

The Drill Pins, Headed Drill Pins and Bone Nails may be hammered in using the Universal Pin Inserter/Extractor (A) or the Universal Pin Inserter (B). The Drill Pins, Headed Drill Pins and Bone Nails may be pulled out using the Universal Pin Inserter/Extractor (A), the Drill Pins and Headed Drill Pins are also designed to be drilled in and removed using the Power Driver (C) or the Power Driver with Snap Lock (D). The Bone Nail may be pulled out using the Universal Pin Inserter/Extractor (A) or the Slaphammer (E).

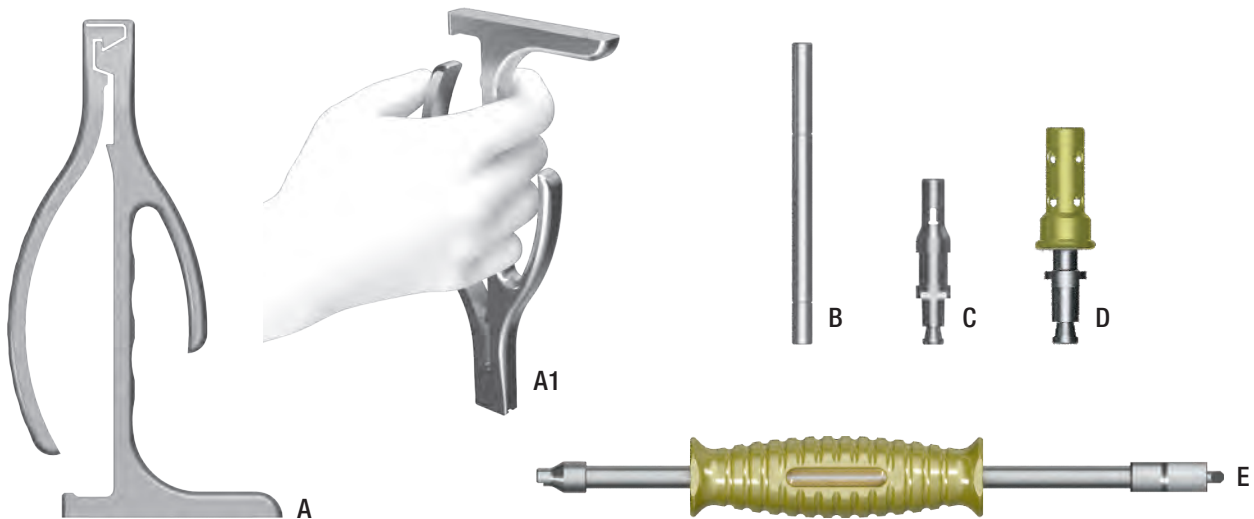

Use the Universal Pin Inserter/Extractor (A) as shown in the picture (A1).

OPTIONAL:











The *LinkSymphoKnee* Instruments are designed to be used also with Thread Pins*, headed or not headed.



ATTENTION: The Thread Pins* are designed to be drilled in and removed using the Power Driver (C) or the Power Driver with Snap Lock (D) only.

* only upon request

The *LinkSymphoKnee* Instruments are designed for use with Sawblades up to a max. thickness of 1.27 mm (page 101).

Compatibility	 Drill Pins	 Headed Drill Pins	 Bone Nails	 Thread Pins*	 Headed Thread Pins*
 Universal Pin Inserter/Extractor	✓	✓	✓		
 Universal Pin Inserter	✓	✓	✓		
 Power Driver	✓	✓		✓	✓
 Power Driver with Snap Lock	✓	✓		✓	✓
 Slaphammer			✓		

*only upon request

Reamers

Cylindrical Reamers:

The Cylindrical Reamers are available in diameters: 10, 11, 12, 13, 14, 15, 16, 17, 18, 19, 20, 22 mm. Different markings on the Reamers show the depths for different stems.

ATTENTION: There are different markings for femur (F) and tibia (T).

ATTENTION: The Cylindrical Reamers can be used only with the Cylindrical Cementless Stems, Cylindrical Press-Fit Stems and Conical Cemented Stems.



Conical Reamers:

The Conical Reamers are available in the following sizes:

- Length: 128 mm, with diameter: 12, 13, 14, 15, 16, 17, 18, 19, 20, 21, 22, 23, 24 mm
- Length: 158 mm, with diameter: 12, 13, 14, 15, 16, 17, 18, 19, 20, 21, 22, 23, 24 mm
- Length: 188 mm, with diameter: 12, 13, 14, 15, 16, 17, 18, 19, 20, 21, 22, 23, 24 mm

ATTENTION: The markings F and T show the depth of the stem on the Femoral side and Tibial side respectively.

ATTENTION: The Conical Reamers can be used only with the Conical Cementless Stems.

ATTENTION: When using the Cementless Modular Stems, ream with increasing diameters until the Reamer has achieved contact with the cortical bone over a continuous distance of approx. 50 mm. The Implant must correspond with the last Reamer used in terms of diameter and length.



Ball Reamers:

The Ball Reamers are available in the diameters:
10, 12, 14, 16, 18, 20, 22, 24, 26 mm

ATTENTION: The Ball Reamers can be used only
with the Conical Cemented Stems.



ATTENTION: In the case of Conical Cemented Stems, the Reamer should be at least 2 mm larger than the planned stem diameter.

Trial Stems

Cylindrical Trial Stems, cementless:



ATTENTION: Must be used for the cementless Cylindrical Stems and Cylindrical Press-Fit Stems only.

Conical Trial Stems, cementless:



ATTENTION: Must be used for the cementless Conical Stems only.

Conical Trial Stems, cemented:



ATTENTION: Must be used for the cemented Conical Stems only.

When using Cemented Conical Stems, a Centralizer must be used. The Centralizers are available in diameter: 12, 14, 16, 18, 20, 22, 24 mm.

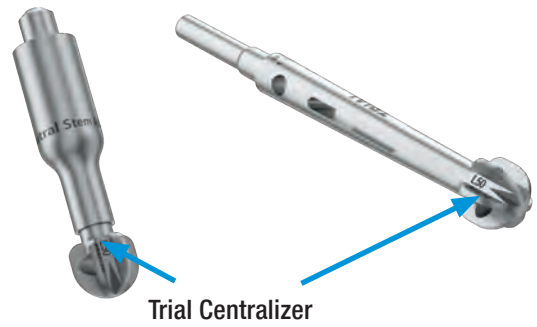

Every Trial Stem has a hole for inserting a screwdriver (AF 2.5) to loosen the Trial Stem when the connection is too tight (04-05).



ATTENTION: The Trial Stems for the 50 mm Cemented Conical Stems feature an in-built Trial Centralizer.

Tibial Preparation

Intramedullary Tibial Guide Assembly

Assemble the appropriate Tibial Cutting Block to the CCK IM Tibial Guide and lock it by twisting the knob of the IM Tibial Guide clockwise until it clicks in the "lock position" (06).

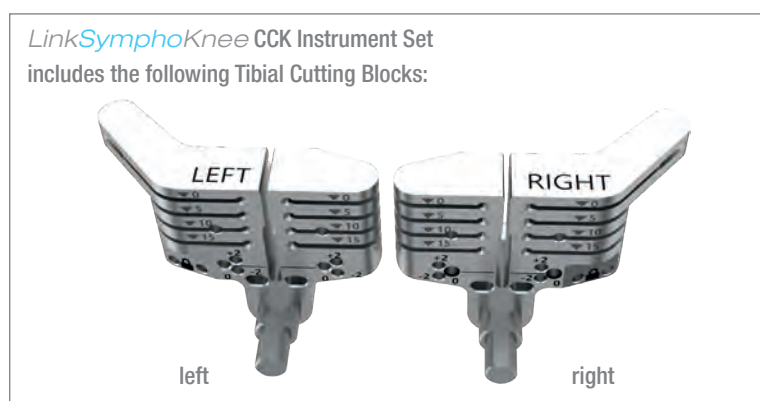
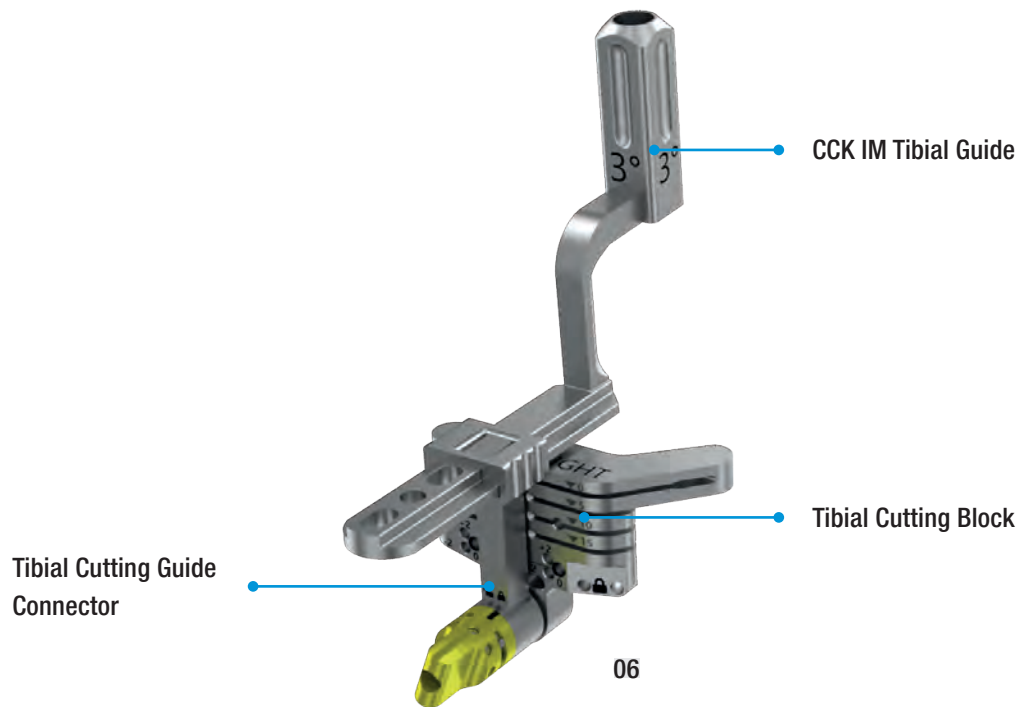

Instruments



881-059/00
CCK IM Tibial Guide 3°



151-202/00
Tibial Cutting
Guide Connector



151-204/00
Tibial Cutting Block,
right

Intramedullary Tibial Guide Alignment

Open the tibial canal using the Step Drill (07).

ATTENTION: In case of primary CCK, the entry point for opening the tibia can be marked with the electrocautery, for example. It is usually located at the point of attachment of the anterior cruciate ligament.

Assemble the Reamer with the T-handle (08). Slowly introduce the Reamer into the canal to prevent building up pressure.

Use the Reamer until it achieves a good stability in the tibial canal.

Slide the CCK IM Tibial Guide assembly onto the Reamer (09).

ATTENTION: After reaming, it is possible to use the Trial Stem Rod Intramedullary assembled to the previously selected Trial Stem. This trial construct can be used, instead of the Reamer, as a guide for all other instruments (09a).

Insert the construct into the bone until reaching the tibial marking (09b).

The Trial Stem Rod Intramedullary must be used when it is planned to implant a stem shorter than or equal to 95 mm.

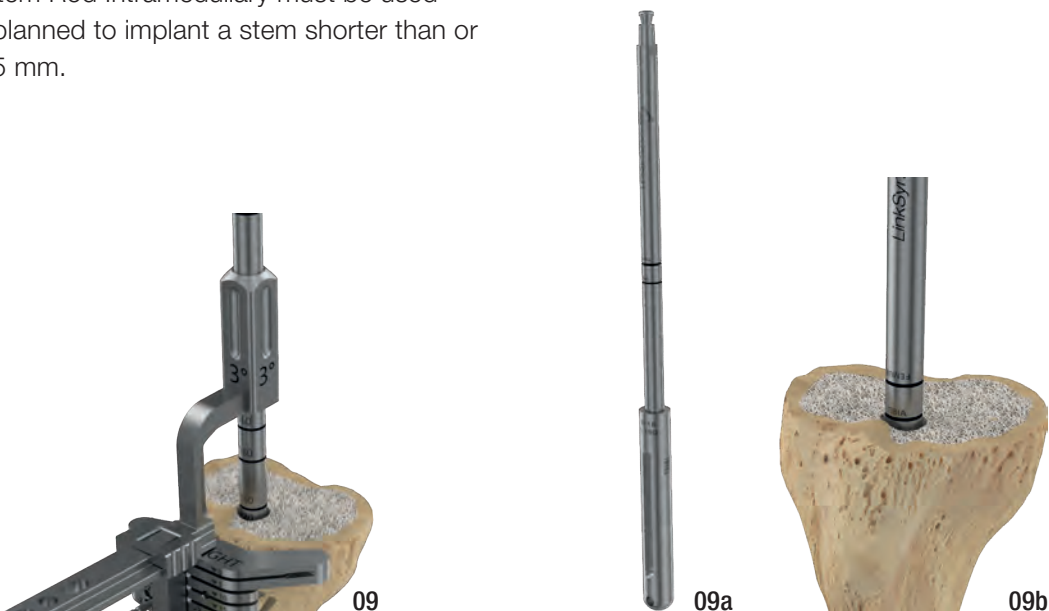

Instruments

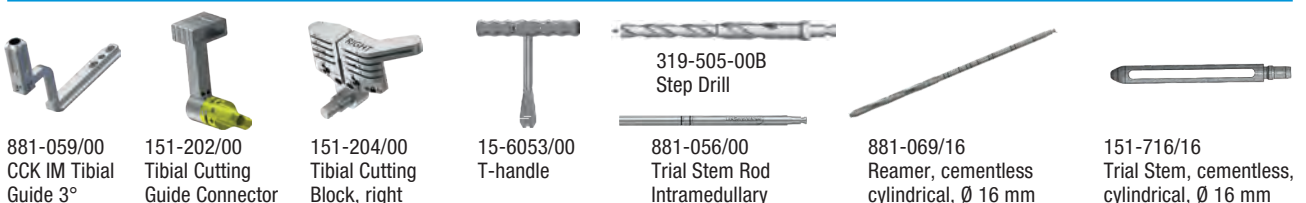

OPTIONAL: To assess tibial alignment, insert the Alignment Rod into the IM-Tibial Guide. Rotation and alignment may be checked by ensuring that the Alignment Rod remains parallel with the tibial axis (10).



Instruments



881-069/16
Reamer, cementless
cylindrical, Ø 16 mm



151-202/00
Tibial Cutting
Guide Connector



445-113/20
Alignment Rod, long



151-204/00
Tibial Cutting Block,
right



881-059/00
CCK IM Tibial Guide 3°

Insert the foot of the Adjustable Stylus into the slot of the Tibial Cutting Block and adjust it to the appropriate level (11).



The scale on the body of the Adjustable Stylus indicates the quantity of bone and residual cartilage to be resected.

ATTENTION: *LinkSymphoKnee* CCK Total Knee System has a minimum tibial component thickness of 10 mm (Tibial baseplate + PE-articulating surface). Take care to restore the joint line.

Set the Adjustable Stylus according to the patient's anatomy, to avoid excessive tibial resection. After the tibial resection level has been set, pin the Tibial Cutting Block through the anterior parallel "0" holes, using two Drill Pins (12).



Disconnect and remove the IM Tibial Guide and the reamer. The resection level may be adjusted by using the distal or proximal pin holes, which move the block 2 mm more proximal or 2 mm more distal. If desired, the Tibial Cutting Block can be fixed with an additional Headed Drill Pin placed through the distal angled hole.

Confirm the tibial resection level using Cutting Template introduced as a free saw blade into the Tibial Cutting Block.

Instruments



Tibial Resection

Resect the tibia using an oscillating saw and a sawblade max. 1.27 mm thick (13).



OPTIONAL: It is possible to add the Quick Connect Handle to the Tibial Cutting Block to check the rotation again (14).

In case of bone loss, use the 5, 10 or 15 mm cutting slot to prepare the bone for Tibial Augments.

ATTENTION: When using only an augment on one side (medial or lateral), use the slot in the middle to perform the sagittal resection (15).



ATTENTION: When using an Offset Stem, prepare the bone for the Tibial Augment in a later stage of the surgical procedure, after setting the offset position and magnitude.

Remove the Tibial Cutting Block and Pins.

Instruments

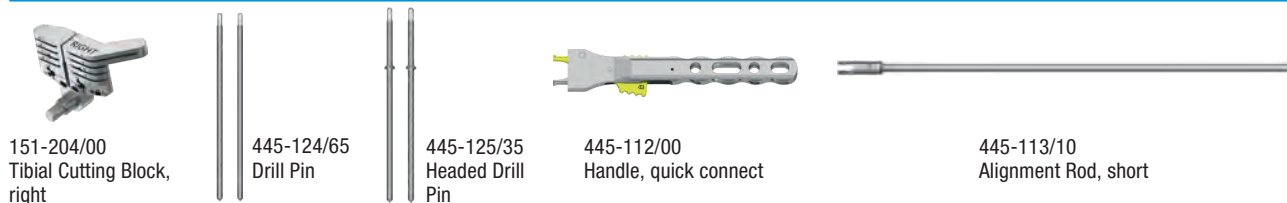

Tibial Preparation

Slowly reposition the Reamer into the tibial canal. Place the Tibial Preparation Plate CCK onto the tibia over the Reamer. Assess the tibial size to achieve maximal coverage of the resected surface (16).



Slide the Offset Selector CCK (17) over the Reamer and assemble it to the Tibial Preparation Plate CCK (18).

Offset Selector CCK:

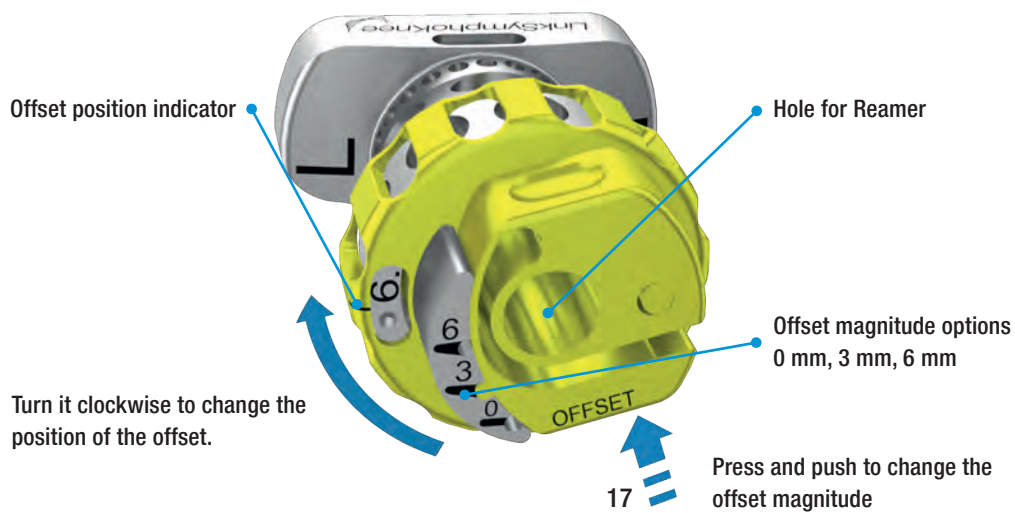

ATTENTION: There is only one way to assemble the Offset Selector onto the Tibial Preparation Plate CCK.



Instruments



881-099/00
Offset Selector CCK



881-285/60
Tibial Preparation Plate CCK,
Size 6



881-069/16
Reamer, cementless
cylindrical, Ø 16 mm

Set the appropriate Offset magnitude and the position.

Check the rotational alignment by inserting the alignment rod into the handle of the Tibial Preparation Plate CCK (19).



19

Fix the Tibial Preparation Plate CCK with 2 Drill Pins (20).



20

Record the magnitude and the position of the Offset from the Offset Selector CCK.

Instruments



881-099/00
Offset Selector CCK



881-285/60
Tibial Preparation Plate CCK,
Size 6



445-113/20
Alignment Rod, long



881-069/16
Reamer, cementless
cylindrical, Ø 16 mm



445-124/65
Drill Pin

Tibial Augment Preparation

In case of bone loss, Tibial Trial Augments are available corresponding to each final tibial augment size and side.

For preparing the tibial bone, slide the Tibial Cutting Block with the CCK Tibial Cutting Guide Connector onto the CCK Tibial Preparation Plate. Remove the Reamer and CCK Offset Selector (21).

Use the medial or lateral (or both) cutting slot at 5, 10 or 15 mm to resect the tibia for the selected augment (height 5, 10, 15 mm).



21

ATTENTION: When using only half augment (medial or lateral), use the slot in the middle to perform the sagittal resection (22).



22



23

Assemble the appropriate Trial Augment under Tibial Preparation Plate (23).

Instruments

					
151-202/00 Tibial Cutting Guide Connector	445-124/65 Drill Pin	445-125/35 Headed Drill Pin	881-335/11 Tibial Trial Augment, Medial-Right/ Lateral-Left, Size 5-6, H = 5mm	151-204/00 Tibial Cutting Block, right	881-285/60 Tibial Preparation Plate CCK, Size 6

Tibial Male Taper Connection Preparation

Attach the Tibial Reamer Guide CCK onto the Tibial Preparation Template (24).

Use the Tapered Reamer CCK until it stops onto the Tibial Reamer Guide CCK (25).



25



24

ATTENTION: When using an Offset Stem, assemble the Offset Reamer Stopper to the Tapered Reamer CCK (26 & 27).



26

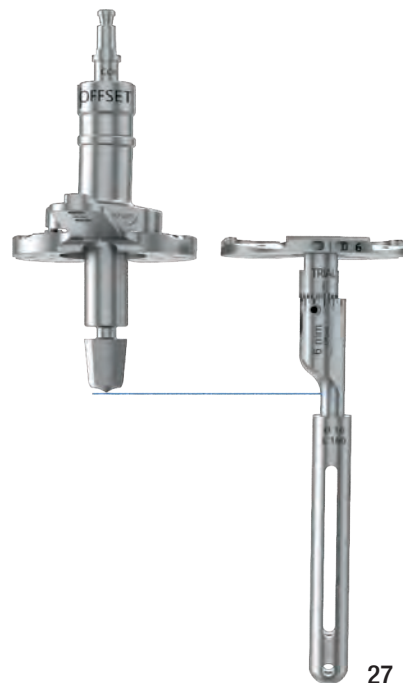

27

ATTENTION: This step of the surgical technique can only be skipped when using straight stems with a diameter bigger than 16 mm.

Instruments



881-285/60
Tibial Preparation Plate CCK,
Size 6



881-065/09
Reamer Stopper, offset



881-065/00
Tibial Reamer Guide, CCK



881-067/17
Tapered Reamer, CCK



445-124/65
Drill Pin

Tibial Trial Component Assembly

In case of bone loss, add the previously selected Tibial Trial Augment to the Tibial Trial Component CCK (28).

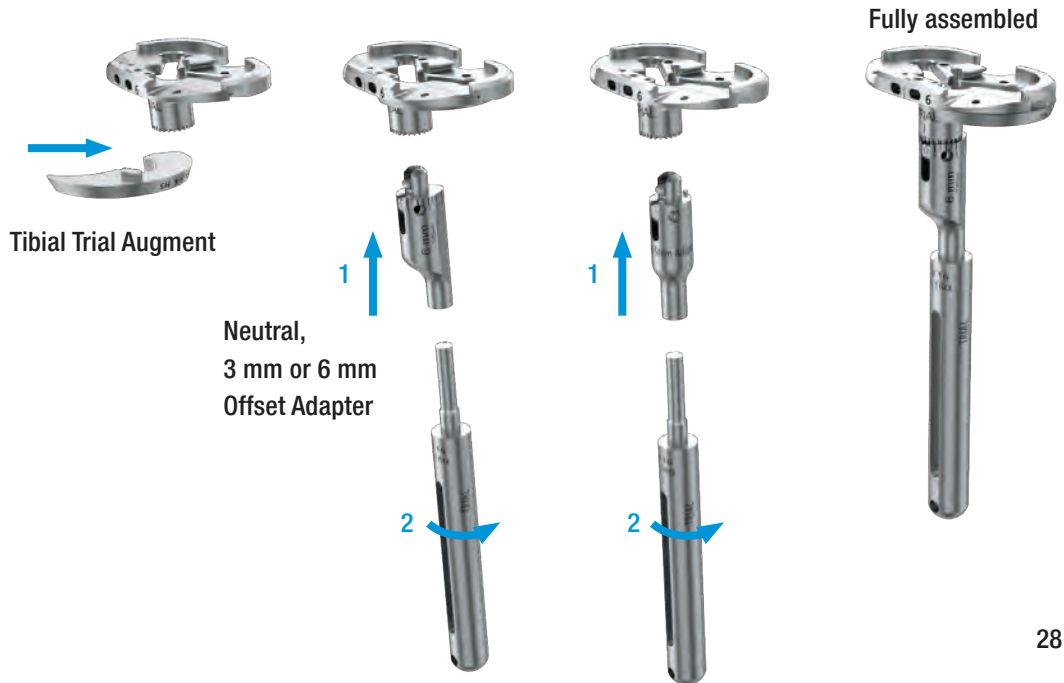

Trial Stem assembly sequence: Tibial Trial Component CCK + (1) Adapter + (2) Trial Stem (28)

ATTENTION: When using an Offset Stem, select the 3 mm or the 6 mm Offset Adapter according to the Offset magnitude previously selected.

For the correct offset position refer to the setting on the CCK Offset Selector (29).

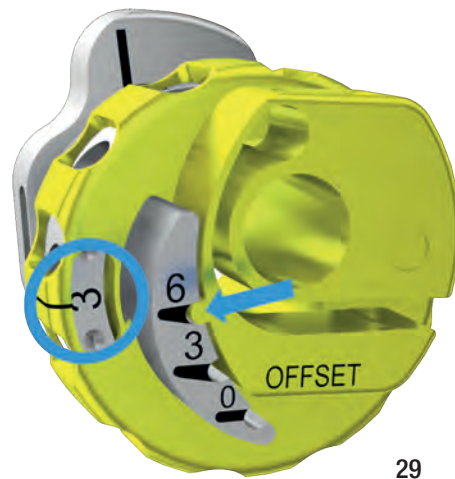

Instruments



The Offset Adapters for the 3 mm and 6 mm offset feature the same markings as on the CCK Offset Selector (30 & 31).

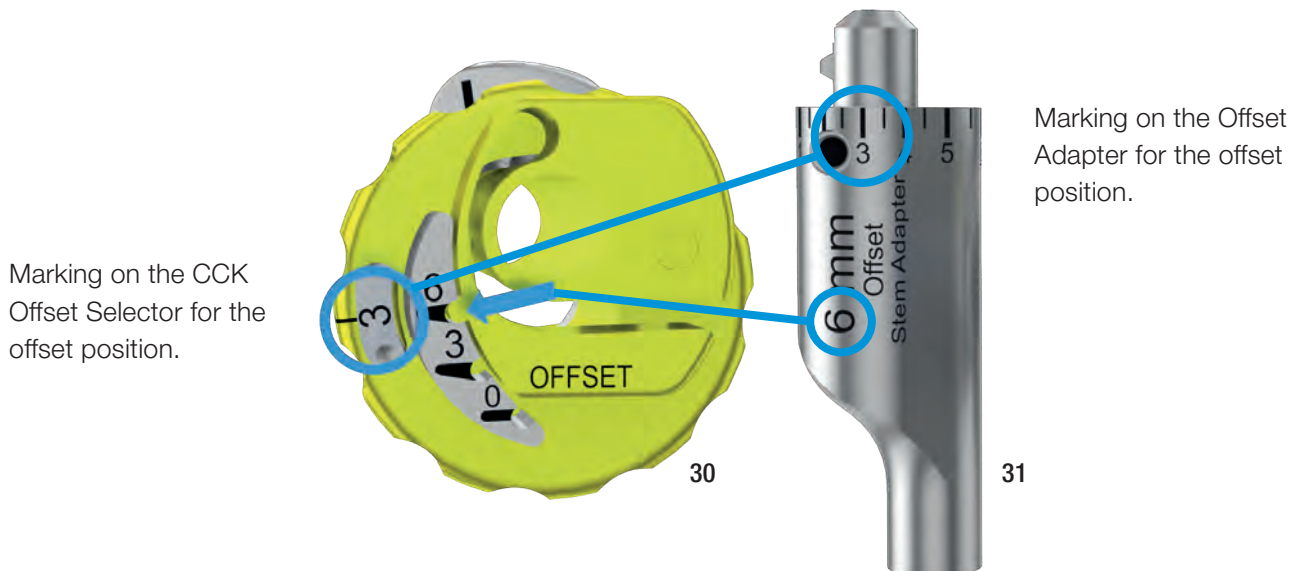

On the ventral/anterior side of the CCK Tibial Trial Component there is a marking that shows the correct reference position for the Trial Offset Adapter (30 & 31a).



Instruments



881-099/00
Offset Selector CCK



151-806/06
6 mm Offset Adapter



881-258/60
Tibial Trial Component,
CCK, Size 6

Once the Trial Stem is assembled, the entire construct is locked and the offset position will not change.

ATTENTION: The length of the assembly (Trial Stem Adapter + Trial Stem) is equal to the length of the final stem implant (32).

ATTENTION: In case of Cemented Stems, assemble a Trial Centralizer (33) to the Trial Stem.

Open the handle of the Tibial Inserter and attach it to the Tibial Trial Component.

Use the Tibial Inserter to slowly introduce the Tibial Trial Component into the tibial bone (34).



32



33



34



35

It is possible to secure the rotation of the Tibial Trial Component using two Bone Nails (L = 25 mm or L = 35 mm) (35).

Instruments



881-258/60
Tibial Trial Component,
CCK, Size 6



445-128/35
Bone Nail



151-806/06
6 mm Offset Adapter



151-106/16
Trial Centralizer, 16 mm



881-042/00
Tibial Inserter



151-716/16
Trial Stem, cementless,
cylindrical, Ø 16 mm

Femoral Preparation

For femoral preparation, the knee is flexed to 90°. The entry point for opening the femur can be marked with the electrocautery, for example. It is usually located approx. 3-5 mm medially above the intercondylar fossa. The medullary canal is opened with the Step Drill (36).

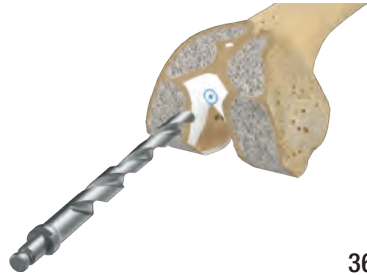

36

Femoral Sizing

The CCK Femoral Sizer Template may be placed over the femur to assess the A/P and M/L size and position (37).



37

Use the Reamer until it achieves a good stability into the femoral canal. Slowly introduce it into the canal to prevent building up pressure.

Slide the handle of the CCK Femoral Sizer Template over the reamer and assess the M/L femoral size (38). The vertical markings on the template handle represent the M/L width of the femoral component.

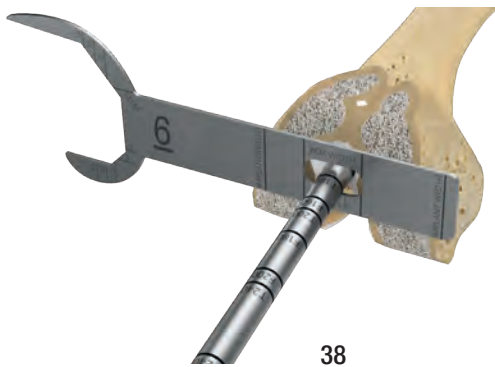

38



38a



38b

ATTENTION: After reaming, it is possible to use the Trial Stem Rod Intramedullary assembled to the previously selected Trial Stem. This trial construct can be used, instead of the Reamer, as a guide for all other instruments (38a).

Insert the construct into the bone until reaching the femoral marking (38b).

The Trial Stem Rod Intramedullary must be used when it is planned to implant stems lengths shorter than or equal to 95 mm.

Instruments



881-069/16
Reamer, cementless
cylindrical, Ø 16 mm



881-056/00
Trial Stem Rod
Intramedullary



151-716/16
Trial Stem, cementless,
cylindrical, Ø 16 mm



881-105/60
Femoral Sizer Template CCK,
Size 6

Femoral Alignment Guide Assembly

In order to lock the CCK Distal Femoral Cutting Block (39), twist the knob of the Femoral Alignment Guide, Varus/Valgus Adjustment 6° clockwise until it clicks in the "lock position" (40).



CCK Femoral Distal Cutting Block

The first cutting slot allows for a clean up cut of 2 mm.

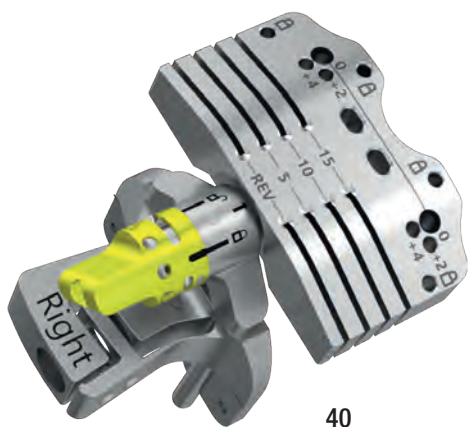

ATTENTION: Ensure that the correct Femoral Alignment Guide, Varus/Valgus Adjustment 6° has been selected. The "Right" one or the "Left" one is selected according to the operated leg.

Instruments



881-159/00
Femoral Cutting Block, CCK,
Distal Cut



881-050/06
Femoral Alignment Guide,
Varus/Valgus Adjustment 6°, right

Femoral Alignment Guide Positioning

Slide the CCK Femoral Alignment Guide over the Reamer.

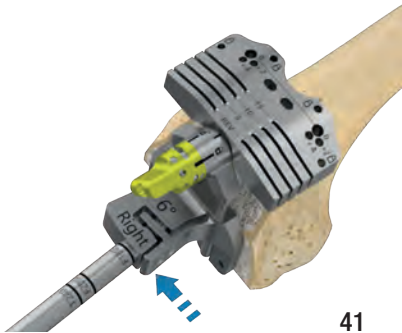

41

ATTENTION: To slide the Alignment Guide onto the Reamer, press the spring on the side of the CCK Femoral Alignment Guide (41).

ATTENTION: Joint line/patella height corrections noted preoperatively should be assessed for any proximal/distal (augment/resection) adjustments.

Note any augment variations for use on the femoral CCK 4-in-1 Cutting Block and Femoral Trial (42).

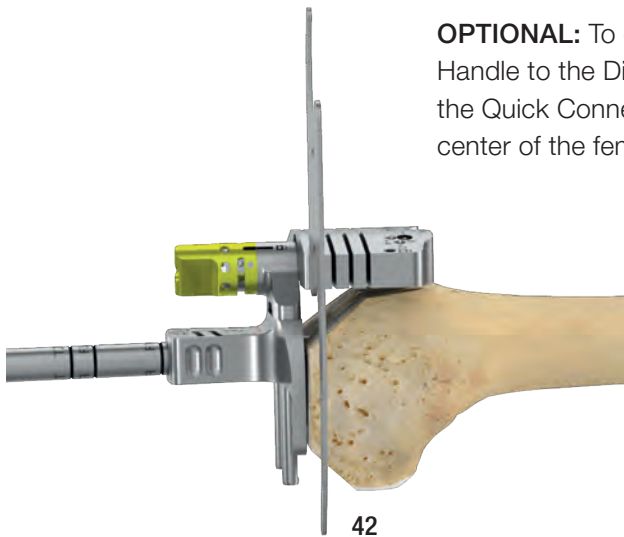

42

OPTIONAL: To confirm the valgus angle, attach the Quick Connect Handle to the Distal Cutting Block and then insert the Alignment Rod into the Quick Connect Handle. Extend the Alignment Rod assembly to the center of the femoral head (43).



43

Instruments



881-069/16
Reamer, cementless
cylindrical, Ø 16 mm



317-802/53
Cutting Template



881-050/06
Femoral Alignment Guide, CCK,
Varus/Valgus Adjustment 6°, right



Alignment Rods: 445-113/10 short, 445-113/20 long



445-112/00
Handle, quick connect



881-159/00
Femoral Cutting Block, CCK,
Distal Cut

The rotation can be checked with markings for the Whiteside line and the epicondylar line (44).

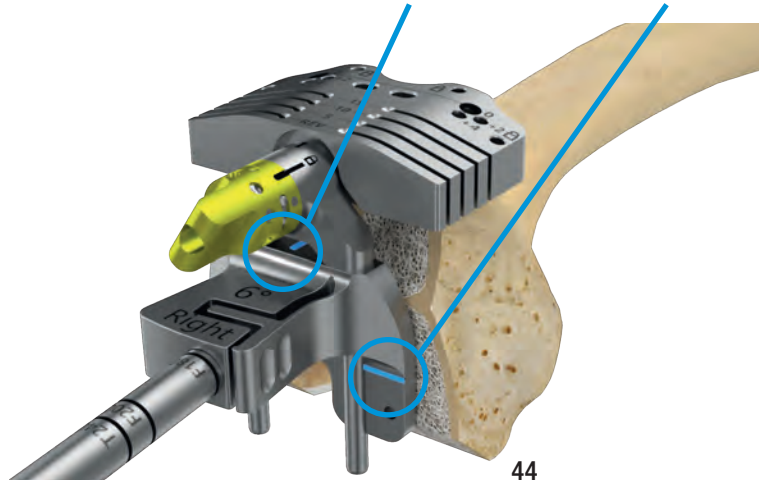

For a stable resection of the distal cut, the Reamer and the CCK Femoral Alignment Guide may be left in situ. To fully secure the CCK Distal Femoral Cutting Block to the femur, two Drill Pins are inserted into the "0" pin holes (45).

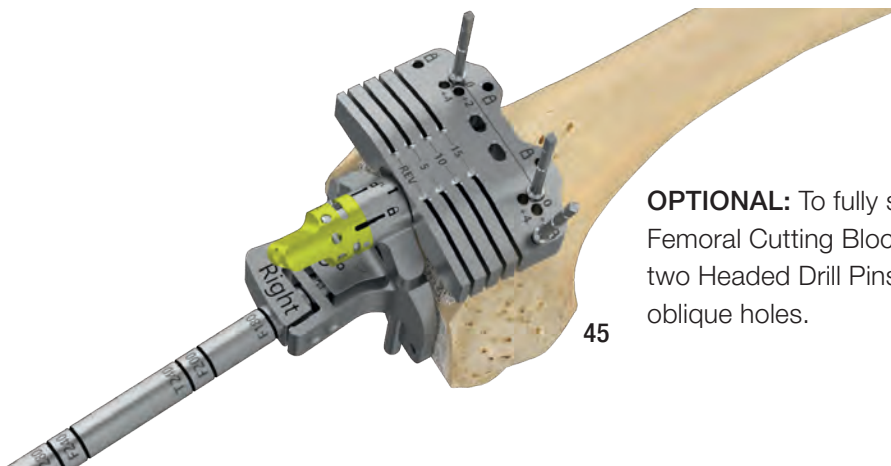

OPTIONAL: To fully secure the CCK Femoral Cutting Block to the femur, two Headed Drill Pins are inserted into oblique holes.

Instruments



881-069/16
Reamer, cementless
cylindrical, Ø 16 mm



881-159/00
Femoral Cutting Block, CCK,
Distal Cut



881-050/06
Femoral Alignment Guide, CCK,
Varus/Valgus Adjustment 6°, right



445-124/65
Drill Pin



445-125/35
Headed Drill
Pin

Distal Femoral Resection

The Cutting Template can be used to check the level of the distal resection. Use an oscillating saw (max. 1.27 mm thick) through the cut slot to resect the distal femur **(46)**.

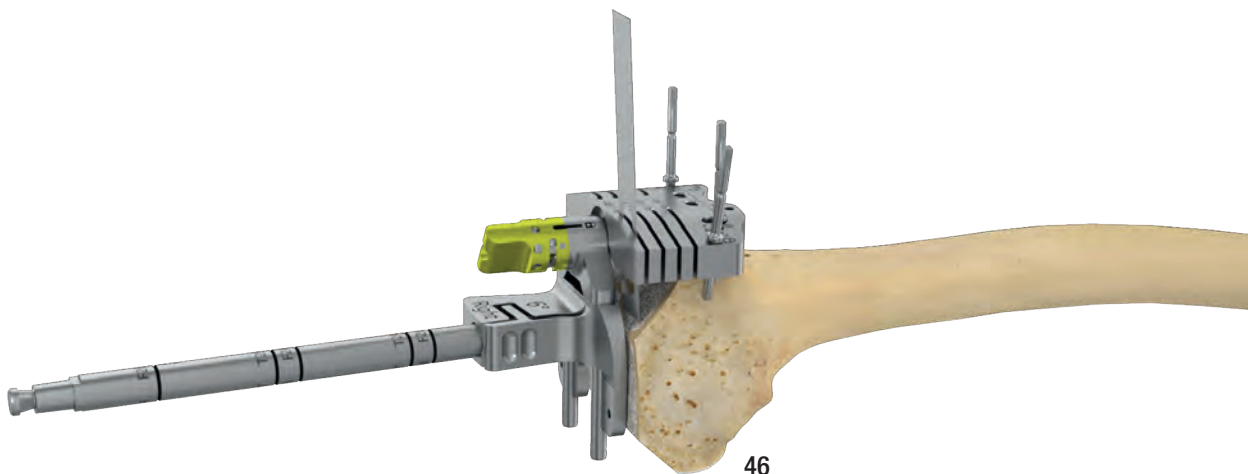

Remove the Pins, the Cutting Block and the CCK Femoral Alignment Guide, leaving the Reamer in situ.

If it is necessary to re-cut the distal femur, reposition the CCK Femoral Cutting Block onto the +2 or +4 holes for a +2 mm re-cut or a +4 mm re-cut respectively.

Instruments



881-069/16
Reamer, cementless
cylindrical, Ø 16 mm



881-159/00
Femoral Cutting Block, CCK,
Distal Cut



881-050/06
Femoral Alignment Guide, CCK,
Varus/Valgus Adjustment 6°, right



445-124/65
Drill Pin



445-125/35
Headed Drill
Pin



317-802/53
Cutting Template

4-in-1 Femoral Cutting Block Assembly

Select the CCK 4-in-1 Femoral Cutting Block that matches the femur A/P size previously determined (47).



ATTENTION: The *LinkSymphoKnee* Instrument Set features eleven CCK 4-in-1 Femoral Cutting Blocks, one for each A/P femoral size. *LinkSymphoKnee* CCK 4-in-1 Femoral Cutting Block mimics precisely the M/L size of the standard final femoral components (0 - 10).

The M/L size of the wide femoral components (3+, 4+, 5+) can be assessed later in the surgical technique.

ATTENTION: Joint line/patella height corrections noted preoperatively and at the Distal femoral resection step should be accounted for in the Femoral Trial Augments selection.

Attach the appropriate Femoral Trial Augment to the posterior face of the CCK 4-in-1 Femoral Cutting Block (48).

ATTENTION: In order to build a 15 mm Femoral Trial Augment, combine a 10 mm + a 5 mm Femoral Trial Augment.

Now assemble the CCK Offset Selector (49) onto the CCK 4-in-1 Cutting Block.

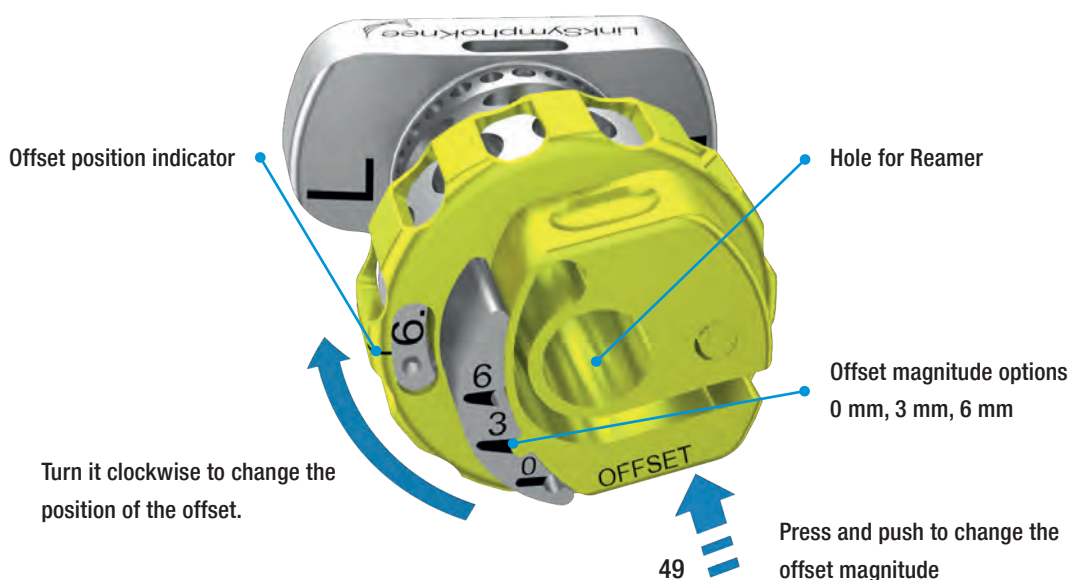

Instruments



881-099/00
Offset Selector CCK



881-115/60
Femoral Cutting Block, CCK,
4-in-1 Cut, Size 6



881-302/91
Femoral Augment Trial, 5 mm

ATTENTION: The CCK Offset Selector can be used either for the left or the right leg. Ensure that the CCK Offset Selector is assembled correctly according to the operated leg (50).

Slide the CCK 4-in-1 Cutting Block construct onto the Reamer (51).

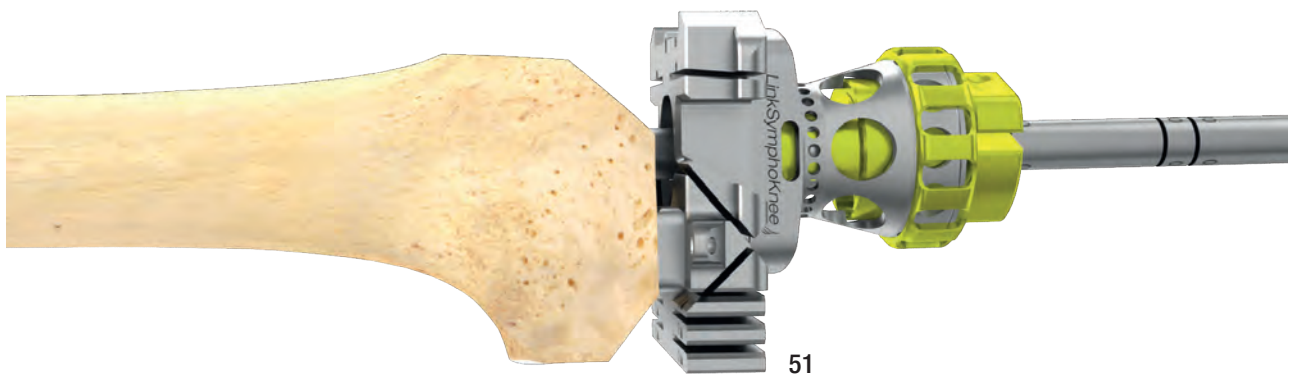
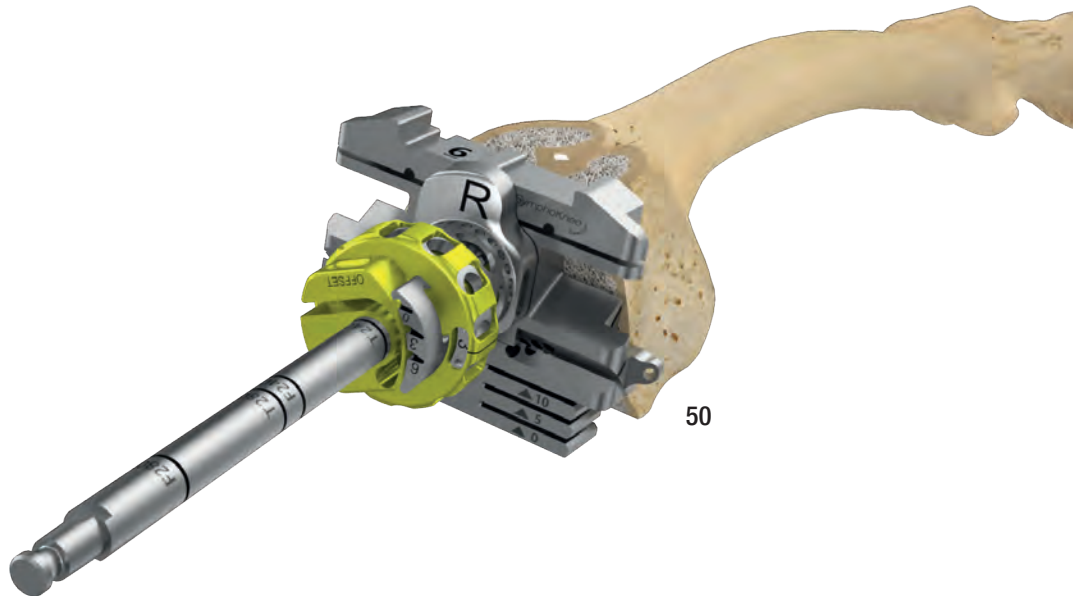

Instruments



881-099/00
Offset Selector CCK



881-302/91
Femoral Augment Trial, 5 mm



881-115/60
Femoral Cutting Block, CCK,
4-in-1 Cut, Size 6



881-069/16
Reamer, cementless
cylindrical, Ø 16 mm

4-in-1 Femoral Cutting Block Positioning

Assess the A/P and M/L position ensuring the rotation of the CCK 4-in-1 Cutting Block is aligned with the epicondylar axis.

OPTIONAL: Insert the Cutting Template through the lateral side of the anterior slot of the CCK 4-in-1 Femoral Cutting Block to verify the correct anterior resection before cutting the femur and to ensure that notching is unlikely to occur (52).

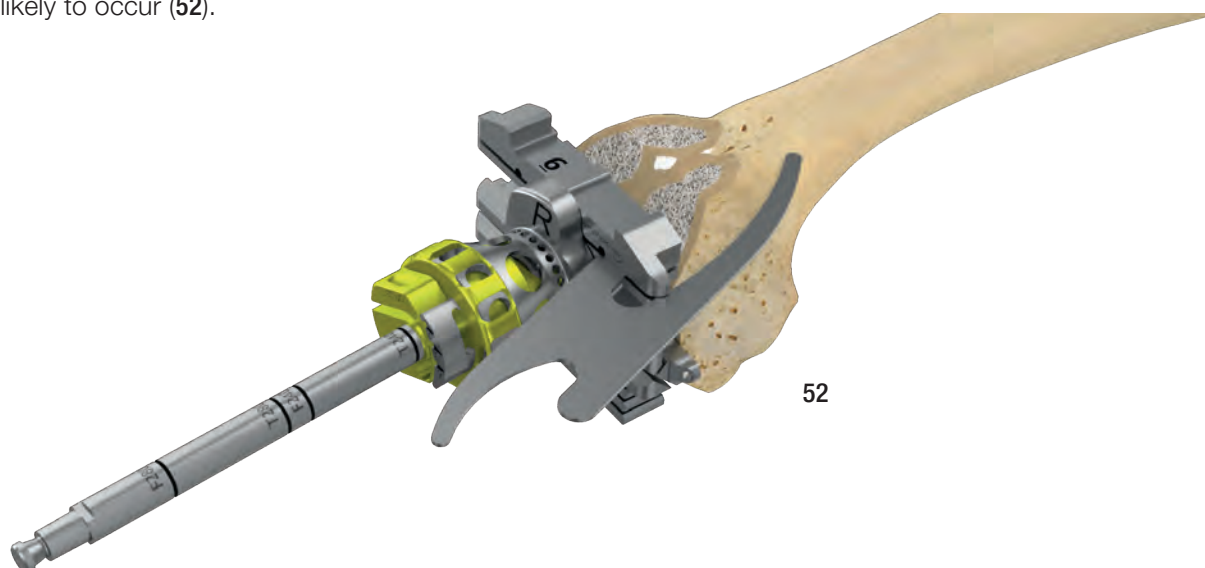

If there is risk of unacceptable notching, it is possible to adjust the Offset magnitude or offset position for prevention.

OPTIONAL: The flexion gap may be checked by using the Flexion Spacer for the 4-in-1 Cut in combination with the CCK 4-in-1 Femoral Cutting Block. The Flexion Spacer is placed between the CCK 4-in-1 Femoral Cutting Block (with its stepped side pushed as far as possible under the unresected femoral condyles) and the resected tibia (53). If needed Shims can be used.



ATTENTION: Use the Flexion Spacer for Micro-Sizes with femoral sizes 0, 1 and 2.

Instruments



881-069/16
Reamer, cementless
cylindrical, Ø 16 mm



881-115/60
Femoral Cutting Block, CCK,
4-in-1 Cut, Size 6



881-011/02
Flexion Spacer 4-in-1 Cut



881-099/00
Offset Selector CCK



317-802/53
Cutting Template

OPTIONAL: Use the CCK Flexion Spacer for the 4-in-1 Cut to check the flexion gap between the CCK 4-in-1 Femoral Cutting Block and the top surface of the Tibial Trial Component CCK (54).

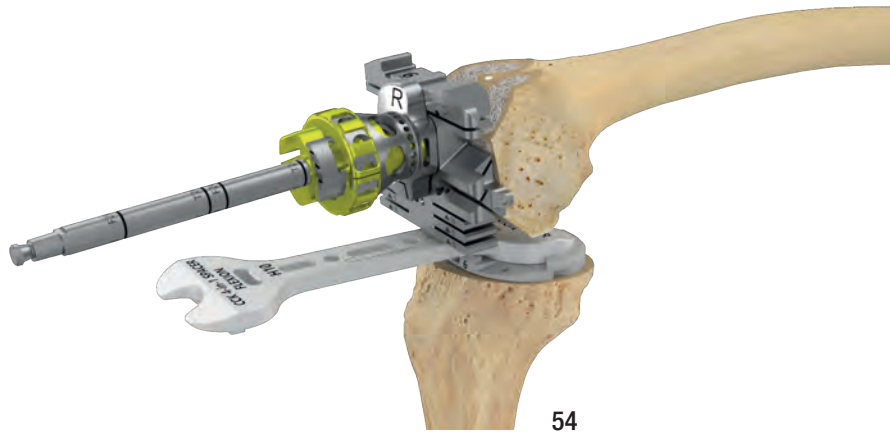

ATTENTION: All Flexion Spacers are used only to assess the flexion gap.

ATTENTION: All Flexion Spacers are designed to assess the flexion gap in combination with the CCK 4-in-1 Femoral Cutting Block.

The Flexion Spacer can be connected to a 4 mm or 8 mm Shim to allow evaluation of multiple thicknesses (55a & 55b):

- 10 mm + 4 mm shim = 14 mm
- 12 mm + 4 mm shim = 16 mm
- 10 mm + 8 mm shim = 18 mm
- 12 mm + 8 mm shim = 20 mm
- 10 mm + 4 mm shim + 8 mm shim = 22 mm
- 12 mm + 4 mm shim + 8 mm shim = 24 mm



55a



55b

Record the magnitude and the position of the Offset.

Instruments



Femoral 4-in-1 Resection

After final placement of the CCK 4-in-1 Femoral Cutting Block, insert two Headed Drill Pins into the oblique pin holes on the medial and lateral aspects of the Cutting Block.

NOTE: when the CCK 4-in-1 Femoral Cutting Block is assembled to a Femoral Augment Trial construct of 15 mm, use the oblique pins located at the opposite side respect to the Femoral Augment Trial.

Protecting the collateral ligaments, use a max. 1.27 mm thick oscillating Sawblade to complete anterior, posterior, posterior chamfer and anterior chamfer resections as well as any 5 mm and 10 mm posterior augment resections (56).

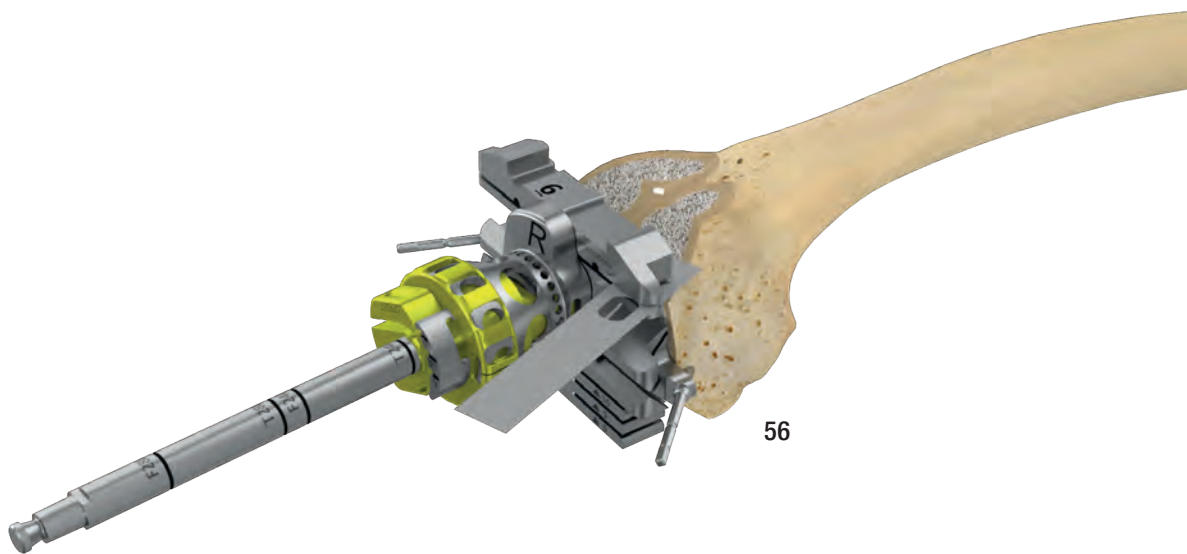

ATTENTION: Use a narrow Sawblade with sizes 0, 1 and 2.

Instruments



881-069/16
Reamer, cementless
cylindrical, Ø 16 mm



881-115/60
Femoral Cutting Block,
CCK, 4-in-1 Cut, Size 6



881-099/00
Offset Selector CCK



445-125/35
Headed Drill
Pin

Femoral Box Preparation

Select the appropriate size of the CCK Box Guide that matches the femur A/P size previously determined.

ATTENTION: The CCK Box Guide is symmetrically designed to permit universal use.

The *LinkSymphoKnee* CCK instruments feature 5 CCK Box Guides (0-1-2, 3-4, 5-6, 7-8 and 9-10)

Assemble the CCK Box Guide to the anterior surface of the CCK 4-in-1 Cutting Block (57).



Instruments

					
445-125/35 Headed Drill Pin	881-115/60 Femoral Cutting Block, CCK, 4-in-1 Cut, Size 6	881-302/91 Femoral Augment Trial, 5 mm	881-069/16 Reamer, cementless cylindrical, Ø 16 mm	881-099/00 Offset Selector CCK	881-114/56 Femoral Box Guide, CCK, Size 5-6

Fix the CCK Box Guide to the bone with two Drill Pins, remove the CCK 4-in-1 Cutting Block, the Reamer and the Offset Selector (58).

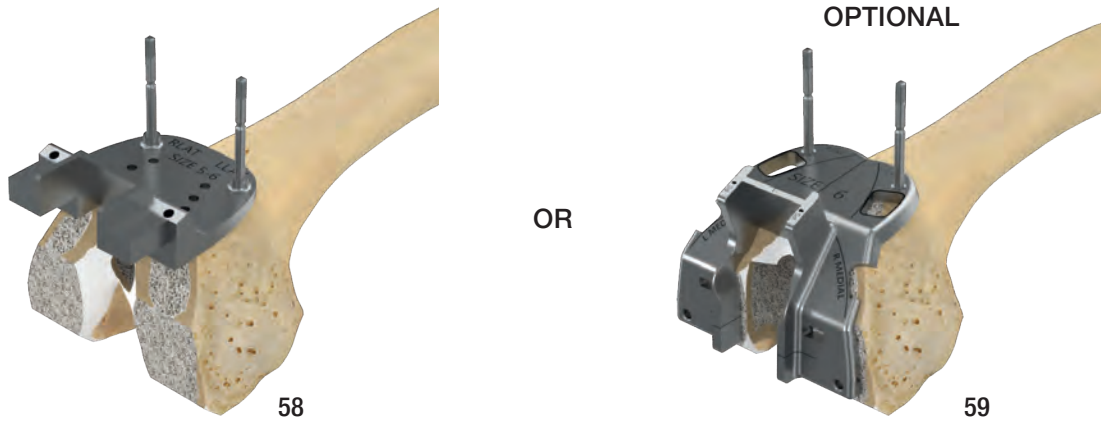

OPTIONAL: The primary PS Box Guide may also be used for the CCK box preparation. The appropriate size of the primary PS Box Guide can be positioned onto the 2 parallel pins of the CCK Box Guide onto the anterior femur (59).

Using a narrow saw blade, resect for the M/L walls and the distal wall of the femoral box through the CCK Box Guide (Anterior/Posterior) (59a).

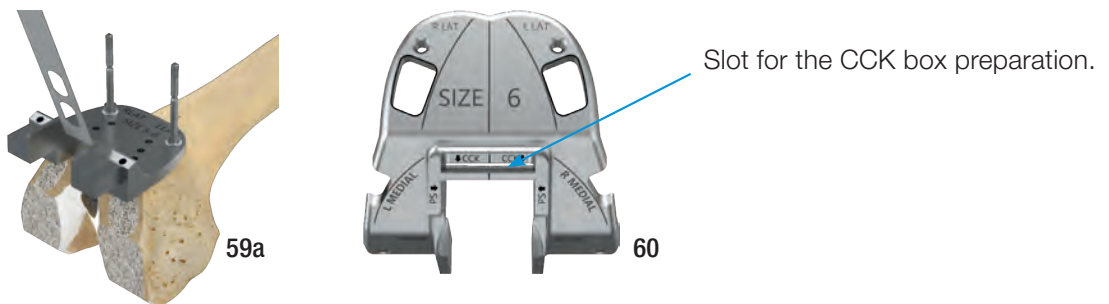

ATTENTION: When completing the notch cut, be careful to avoid excessive angulation of the Saw Blade or penetration past the posterior femoral cortex to avoid injury to the neurovascular structures. Avoid undercutting the condyles.

ATTENTION: When using the primary PS Box Guide, use the CCK cutting slot to resect the distal wall of the femoral box (60).

ATTENTION: When using the primary PS Box Guide, attach the Femoral Trial Augment to increase the stability of the construct in case of bone loss (60a & 60b).

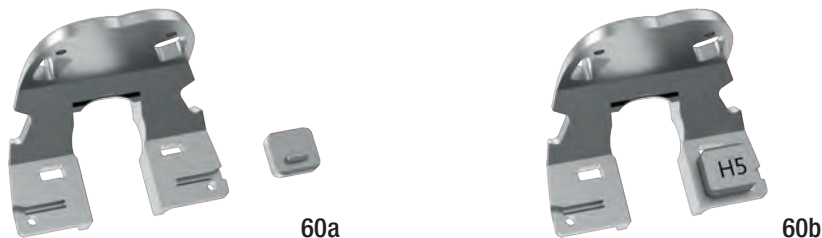

Instruments



Femoral Male Taper Connection Prepatation

Attach the CCK Femoral Box Reamer Guide onto the CCK Box Guide (61) or to the primary PS Box Guide (61b).

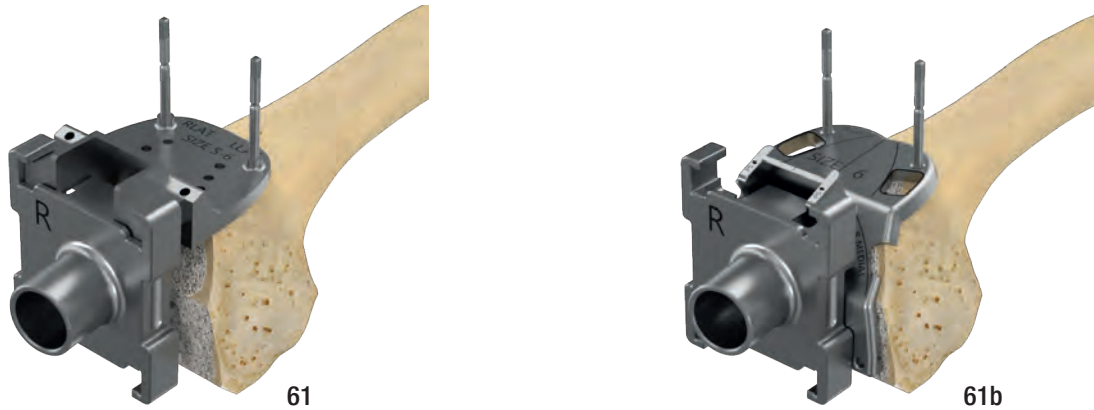

ATTENTION: The CCK Femoral Box Reamer can be used for a LEFT and for a RIGHT knee. Take care to assemble it properly according to the operated leg (61 & 61b).

Use the Tapered Reamer CCK until it stops onto the CCK Femoral Box Reamer Guide (62).

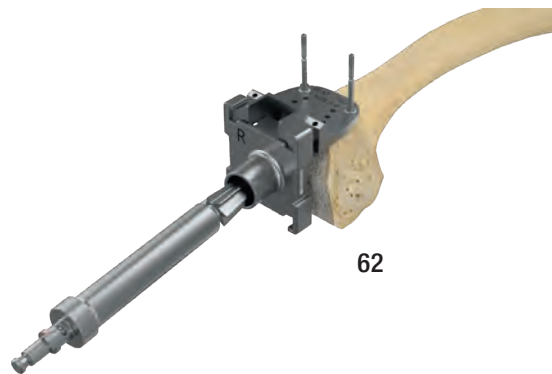

ATTENTION: When using an Offset Stem, assemble the Offset Reamer Stopper to the Tapered Reamer CCK (63 & 64).

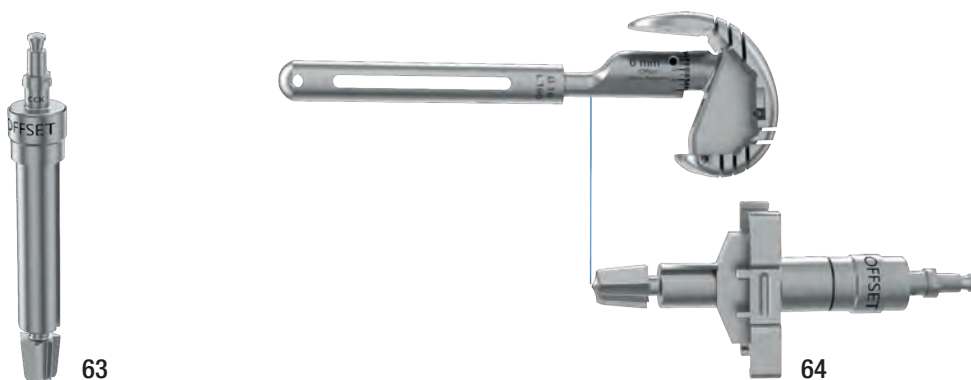

ATTENTION: This step of the surgical technique can only be skipped when using not-offset stems with diameter bigger than 16 mm.

Instruments

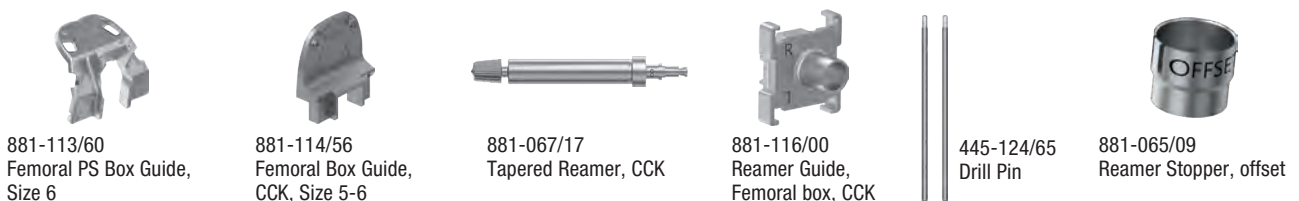

Femoral Trial Assembly

The *LinkSymphoKnee* CCK Instrument Set features a specific femoral trial component for each CCK femoral size.

In case of bone loss, add the previously selected Femoral Trial Augments to the CCK Femoral Trial Component (65).

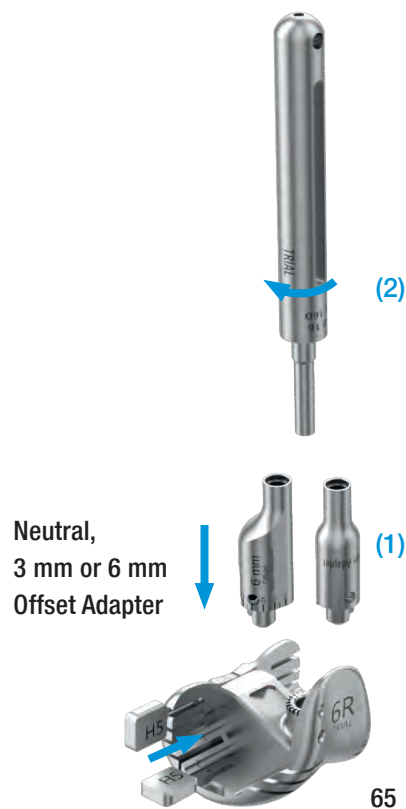

Trial Stem assembly sequence: CCK Femoral Trial Component + (1) Adapter + (2) Trial Stem (65).

ATTENTION: When using an Offset Stem select the 3 mm or the 6 mm Offset Adapter according to the Offset magnitude previously selected.

For the correct position refer to the setting on the CCK Offset Selector (66).

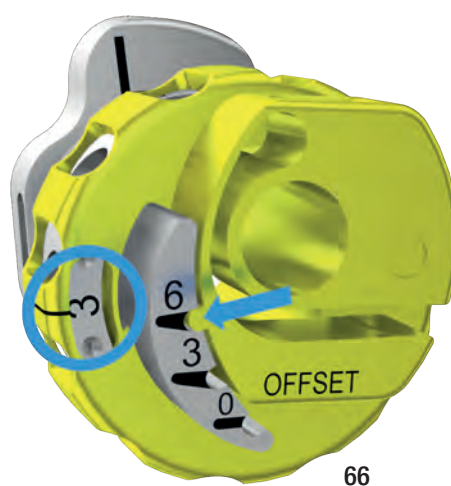

Instruments



881-099/00
Offset Selector
CCK



151-806/06
6 mm Offset Adapter



151-501/00
Neutral Stem Adapter



151-716/16
Trial Stem, cementless,
cylindrical, Ø 16 mm



881-150/60
Femoral Trial CCK,
right, size 6



881-302/91
Femoral Augment Trial,
5 mm

The Trial Offset Adapters for the 3 mm and 6 mm offset have the same markings as the CCK Offset Selector (67).

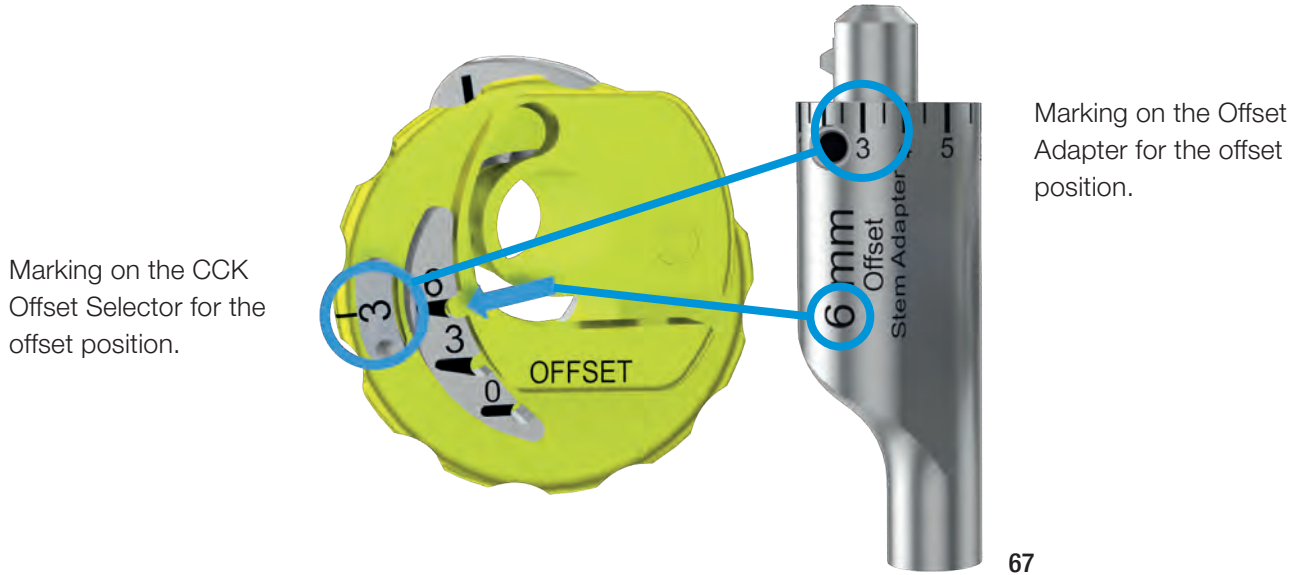

On the lateral side of the box of the CCK Femoral Trial Component there is a marking that shows the correct reference position for the Trial Offset Adapter (68).

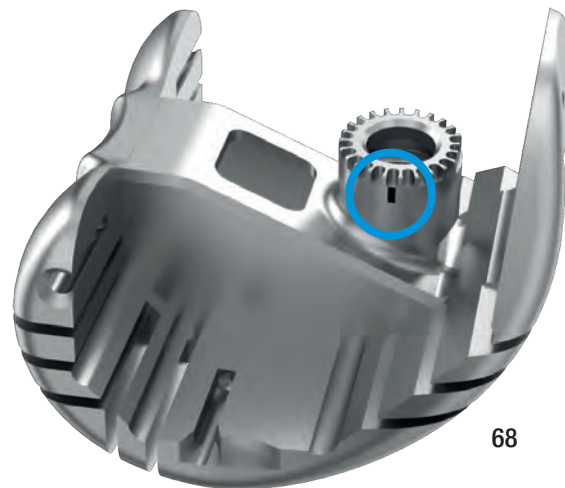

Instruments



881-150/60
Femoral Trial CCK,
right, size 6



151-806/06
6 mm Offset Adapter



881-099/00
Offset Selector
CCK

Once the Trial Stem is assembled, the entire construct is locked and the offset position will not change.

ATTENTION: The length of the assembly (Trial Stem Adapter + Trial Stem) is equal to the length of the final stem (69).



ATTENTION: In case of Cemented Stems, assemble a Trial Centralizer (70) to the Trial Stem.



Use the Femoral Inserter/Extractor to slowly introduce the CCK Femoral Trial Component into the femoral bone (71).

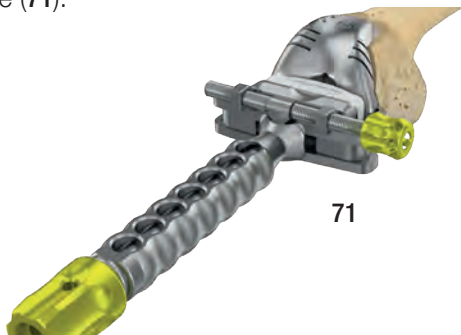

OPTIONAL: It is feasible to resect the bone for femoral augments using an oscillating sawblade through the CCK Femoral Trial Component (73).

Release the Femoral Inserter/Extractor and use the Femoral Impactor Tip (assembled to the Impactor/Extractor Handle) to complete the trial component impaction (72).

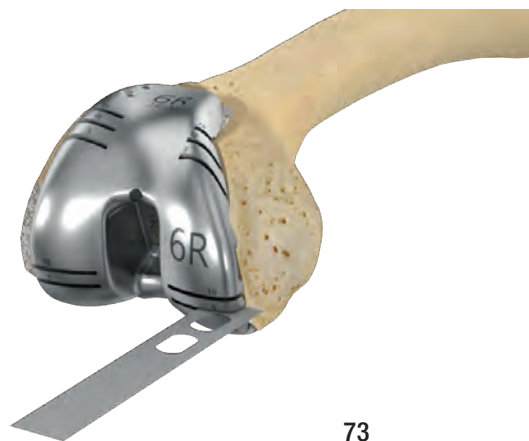

It is possible to secure the position of the Trial Femoral Component using pins.

Instruments

						
151-106/16 Trial Centralizer, 16 mm	151-806/06 6 mm Offset Adapter	881-041/00 Femoral Inserter/Extractor	151-716/16 Trial Stem, cementless, cylindrical, Ø 16 mm	881-150/60 Femoral Trial CCK, right, size 6	445-207/00 Impactor/Extractor Handle	881-041/99 Femoral Impactor Tip

Trial Reduction

Perform a trial reduction with all trial components – CCK Femoral Trial Component, Tibial Trial Component CCK and CCK Trial Plateau (73).



74



74a

Select the appropriate size of the CCK Trial Plateau. The following table shows the possible size combinations:

		CCK Femoral Component										
		0	1	2	3/3+	4/4+	5/5+	6	7	8	9	10
Tibial Component	1	CCK Articulating Surface 1-2			CCK Articulating Surface 1-2up		x	x	x	x	x	x
	2	CCK Articulating Surface 1-2			CCK Articulating Surface 1-2up		x	x	x	x	x	x
	3	x	CCK Articulating Surface 3-4down			CCK Articulating Surface 3-4			x	x	x	x
	4	x	CCK Articulating Surface 3-4down			CCK Articulating Surface 3-4			x	x	x	x
	5	x	x	x	CCK Articulating Surface 5-6						x	x
	6	x	x	x	CCK Articulating Surface 5-6						x	x
	7	x	x	x	x	x	CCK Articulating Surface 7-8					
	8	x	x	x	x	x	CCK Articulating Surface 7-8					
	9	x	x	x	x	x	x	x	CCK Articulating Surface 9-10			
	10	x	x	x	x	x	x	x	CCK Articulating Surface 9-10			

Symbol Description: x = Combination not permitted

Select the appropriate thickness of the CCK Trial Plateau:

10 mm, 12 mm, 14 mm or 16 mm.

ATTENTION: For adjusting the height of the Trial Plateau beyond 16 mm, use the +4 mm Shim or the +8 mm Shim (74) in the following combinations:

14 mm Trial Plateau + 4 mm Shim = 18 mm

12 mm Trial Plateau + 8 mm Shim = 20 mm

14 mm Trial Plateau + 8 mm Shim = 22 mm

16 mm Trial Plateau + 8 mm Shim = 24 mm

Instruments



881-250/85
Shim Trial Plateau, CCK
H = +8 mm, size 5-6



151-716/16
Trial Stem, cementless,
cylindrical, Ø 16 mm



881-258/60
Tibial Trial Component,
CCK, Size 6



881-255/10
Trial Plateau CCK,
Size 5-6, H = 10 mm



881-150/60
Femoral Trial CCK,
right, size 6



151-806/06
6 mm Offset Adapter

ATTENTION: Always use a stem with the Femoral and with the Tibial Component when implanting a *LinkSymphoKnee* CCK Articulating Surface.

ATTENTION: For more implant options please refer to the *LinkSymphoKnee* CR-PS-PS+ Surgical Technique.

OPTIONAL: It is possible to fix the CCK Trial Plateau to the CCK Tibial Trial Component using a Trial Plateau Locking Screw. Select the Short Tibial Plateau Locking Screw when using a CCK Trial Plateau without Shim or with the +4 mm Shim (75), whereas use the Long Tibial Plateau Locking Screw when using a CCK Trial Plateau with +8 mm Shim (76).

Use the Torque Wrench (hex 2.5 mm) to lock the Trial Plateau Locking Screw in place (77).

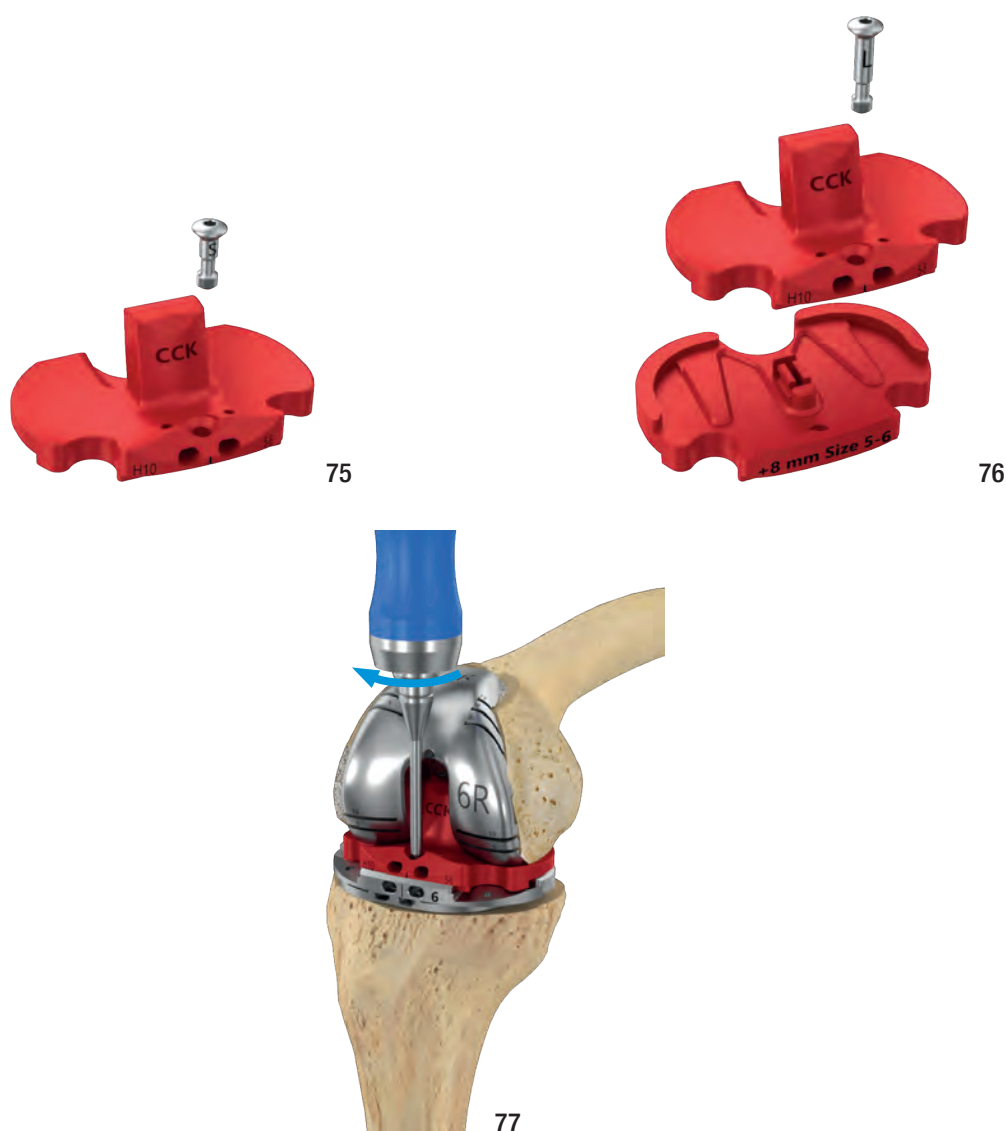

Instruments



881-250/85
Shim Trial Plateau, CCK
H = +8 mm, size 5-6



151-716/16
Trial Stem, cementless,
cylindrical, Ø 16 mm



881-258/60
Tibial Trial Component,
CCK, Size 6



881-255/10
Trial Plateau CCK,
Size 5-6, H = 10 mm



Locking Screws Tibial Plateau:
881-052/00 Short, 881-053/00 Long



151-806/06
6 mm Offset Adapter

Final Preparation

Attach the size-specific CCK Tibial Keel Punch to the Impactor/Extractor Handle.

Choose the appropriate CCK Tibial Keel Punch according to the size of the CCK Tibial Trial Component.

ATTENTION: The *LinkSymphoKnee* Instrument Set features five CCK Tibial Keel Punches, each for two tibial sizes: 1-2, 3-4, 5-6, 7-8 and 9-10.

After confirming the rotation of the CCK Tibial Trial Component, carefully impact the CCK Tibial Keel Punch until it is fully seated onto the CCK Tibial Trial Component (78).

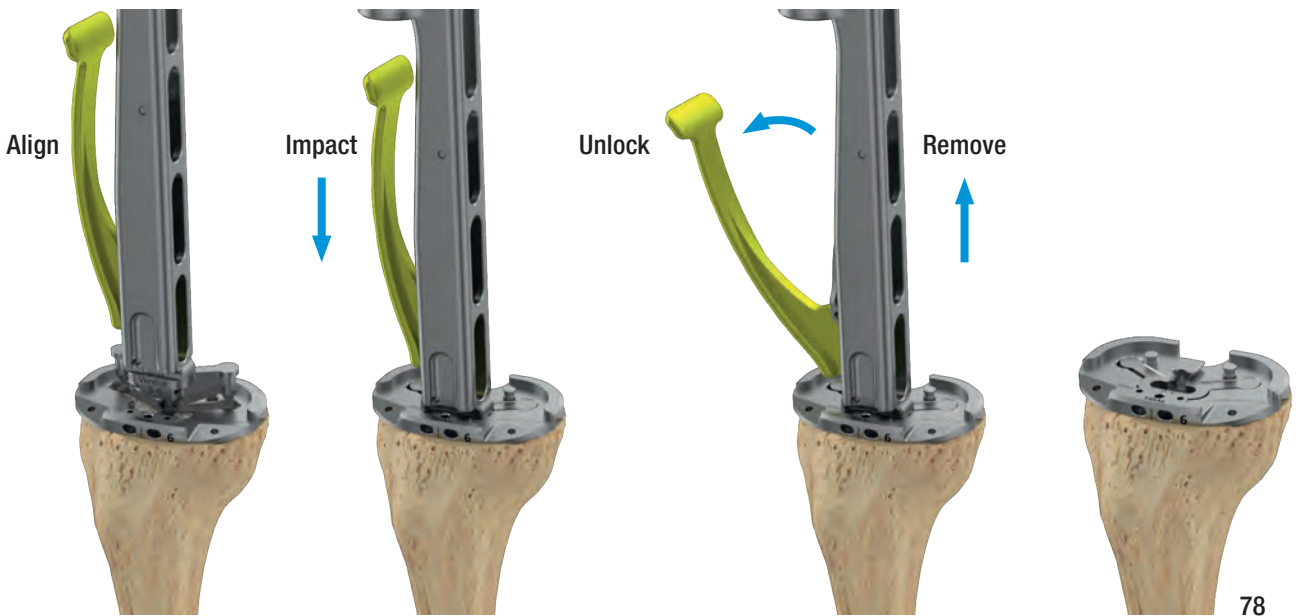

OPTIONAL: It is possible to perform a final trial reduction (79).

Make sure that no bony structures (e.g. osteophytes) or local soft tissue interfere with the range of motion.

Remove the Tibial Trial Component assembly.

Instruments

						
445-207/00 Impactor/Extractor Handle	881-258/60 Tibial Trial Component, CCK, Size 6	881-255/10 Trial Plateau CCK, Size 5-6, H = 10 mm	881-275/56 Tibial Keel Punch CCK Size 5-6	151-806/06 6 mm Offset Adapter	151-716/16 Trial Stem, cementless, cylindrical, Ø 16 mm	881-150/60 Femoral Trial CCK, right, size 6

Extraction of Femoral Trial Component

OPTIONAL: In order to extract the Femoral Trial Components, it is possible to use the Slaphammer in combination with the Femoral Inserter/Extractor (80).

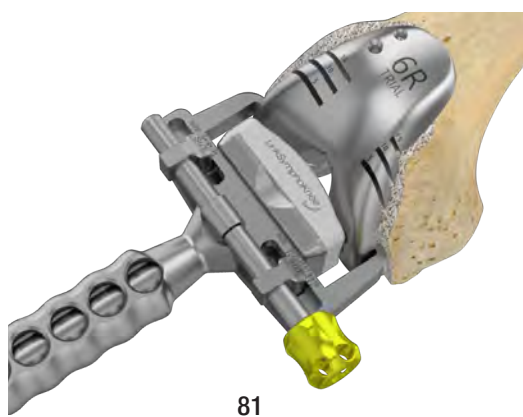

Assemble the Femoral Inserter/Extractor on the CCK Femoral Trial Component (81).

Use the Slaphammer to remove the Femoral Trial assembly (82).

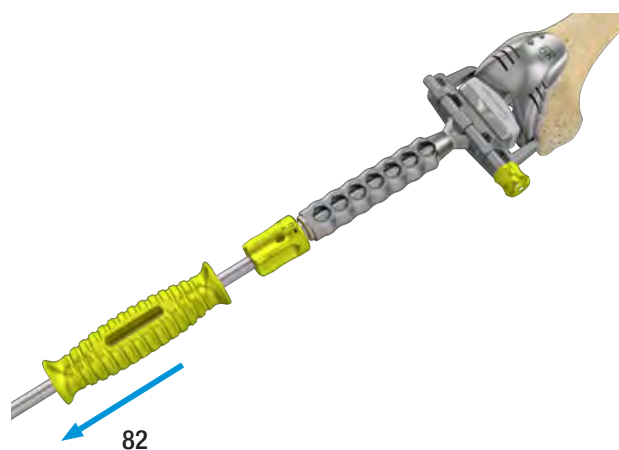

Instruments



445-206/00
Slaphammer



881-041/00
Femoral
Inserter/Extractor



881-150/60
Femoral Trial CCK, right,
size 6



151-806/06
6 mm Offset Adapter



151-716/16
Trial Stem, cementless,
cylindrical, Ø 16 mm

Patella Preparation (Patella Resurfacing)

The following instructions describe how to use the *LinkSymphoKnee* Patella Component and they assume the use of the instrument set available for this procedure.

Sizing

A Patella Sizing Template corresponding to the implants is available (83). The size of implant is determined by placing the Sizing Template slightly medial and superior on the patella surface (84).



ATTENTION: The *LinkSymphoKnee* system includes 6 sizes of Patella Components. Each size features a different implant thickness and diameter. In the table below, all Patella Component dimensions are shown.

LinkSymphoKnee Patella Components – 3-peg

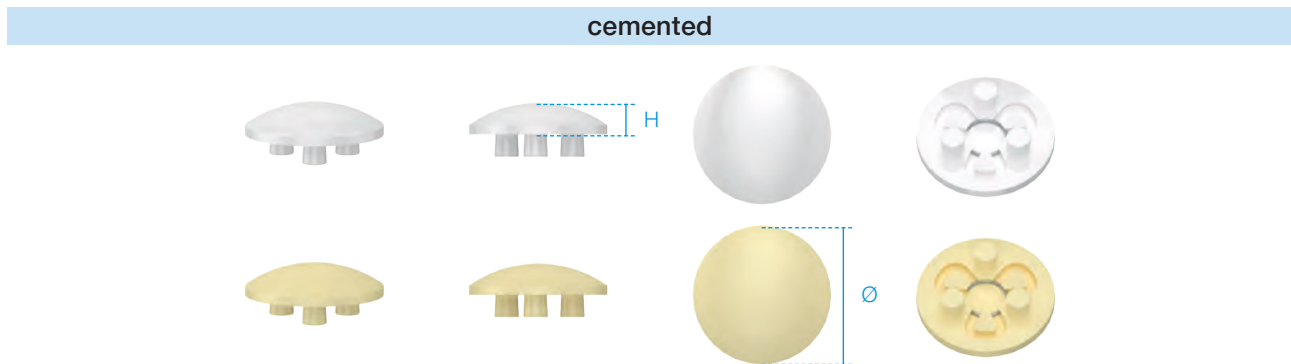

REF MAT UHMWPE	REF MAT E-Dur*	Ø mm	Height (H) mm
880-501/25	880-511/25	25	6
880-501/28	880-511/28	28	6
880-501/31	880-511/31	31	7
880-501/34	880-511/34	34	8
880-501/37	880-511/37	37	9
880-501/40	880-511/40	40	10

* E-Dur = Highly crosslinked UHMWPE (X-Linked PE) with Vit-E

Instruments



881-509/00
Patella Sizing Template



Patella Resection

Insert the Resection Guide (A) into the second groove from the top of the Patella Clamp Handle (B) (85). Now, insert the Depth Gauge (C) into the first groove from the top of the Patella Clamp Handle (B) (86).

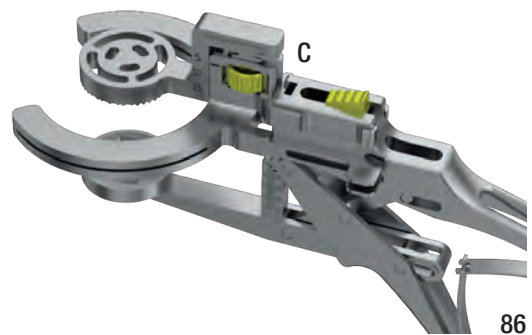

Set the appropriate resection level corresponding to the size of the patella component previously determined (87).



Position the Patella Clamp so that the sectional plane lies parallel to the extended patellar tendon. The Depth Gauge must lie on the bone. While pressing the hand grips, the Patella Clamp firmly fixes the patella by means of the integrated ratchet (88). If necessary, release the ratchet by pressing the trigger on the Patella Clamp Handle.

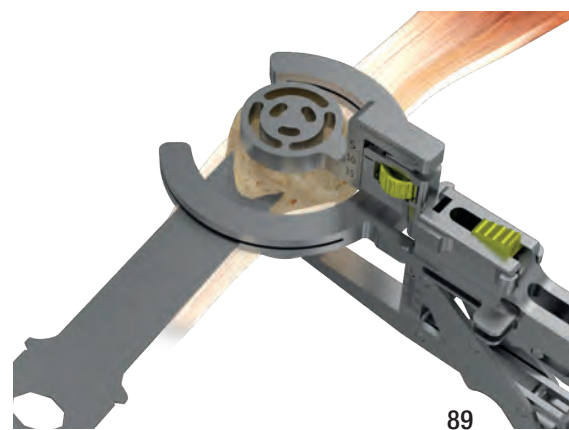
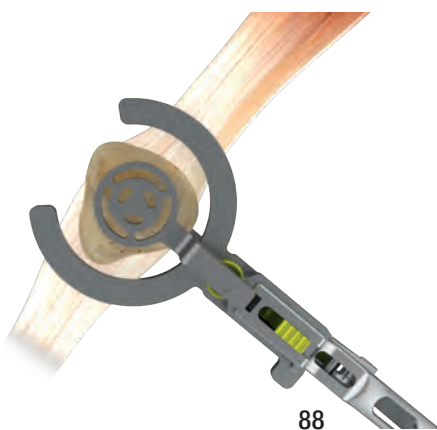

ATTENTION: It is important to ensure that the remaining patella is sufficiently thick (min. 12 mm).

The resection is carried out using an oscillating saw with a max. 1.27 mm thick Sawblade. The saw is guided using the saw slots of the Resection Guide (89).

Instruments



Drilling the Anchoring Holes

Insert the Drill Guide (E) for the anchoring holes into the first slot from the top of the Patella Clamp Handle (B) (90).

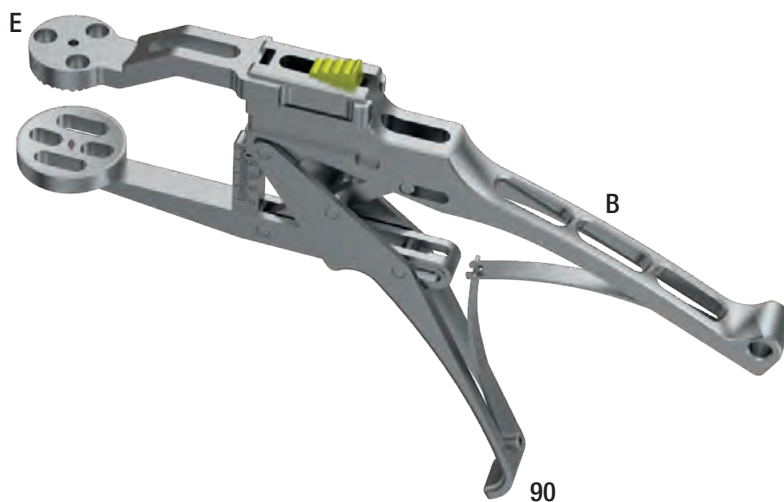

Position the Patella Clamp onto the previously resected patella surface and use the Universal Drill (H) for the anchoring holes. To prepare the seat for the anchoring holes, push the Universal Drill until stop (91). A Patella Trial can now be used (91a).

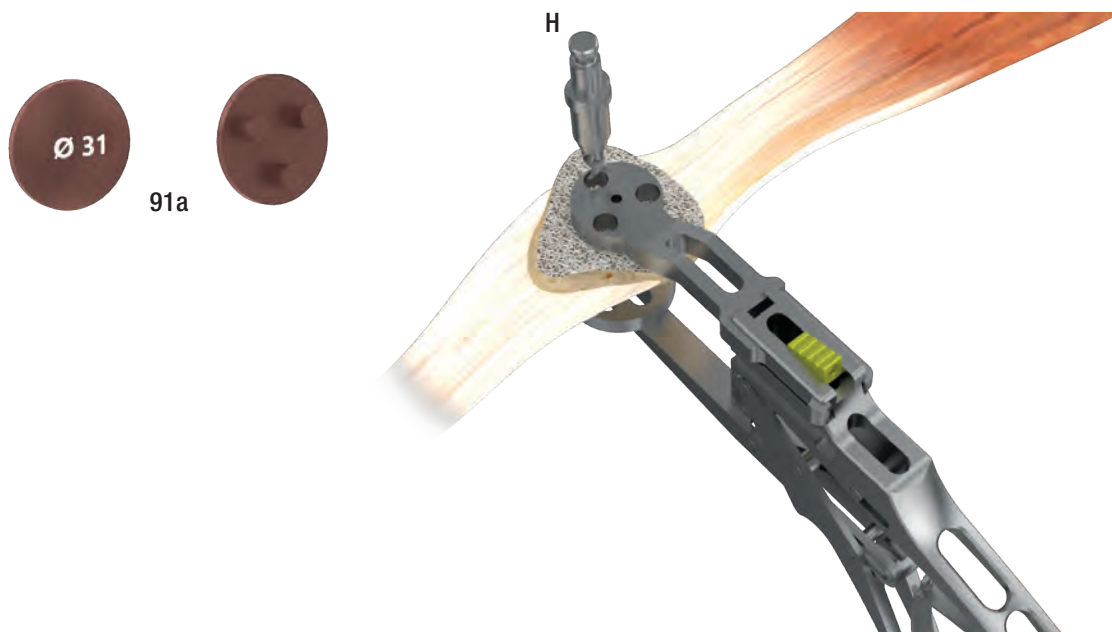

Instruments



445-902/00
Patella Clamp,
Handle



881-012/00
Universal Drill,
Hudson Fitting (B)



881-511/31
Patella Clamp,
Drill Guide size 31



881-501/31
Patella Trial,
Ø 31 mm

Final Implantation

Augment Assembly

Select the appropriate sized Femoral/Tibial Components and the matching sized Femoral/Tibial Augment.

Using the Tibial and Femoral Trials as a guide, assemble the Femoral and/or Tibial Augment with the Torque Wrench (hex 2.5 mm) (**93** & **94**).

NOTE: Screws are preassembled to the augments.



Instruments



15-2545
Torque Wrench, hex 2.5 mm

Modular Stem Assembly

ATTENTION: Carefully remove the Safety Cap from the taper. The Safety Cap protects the Cone Adapter during transportation (95).

ATTENTION: The Cone Adapter is pre-assembled to the Femoral and Tibial implant.

ATTENTION: If the Cone Adapter is not assembled or is loose, use the Screwdriver for the Cone Adapter to tighten it to the femoral and tibial component (96 & 97).

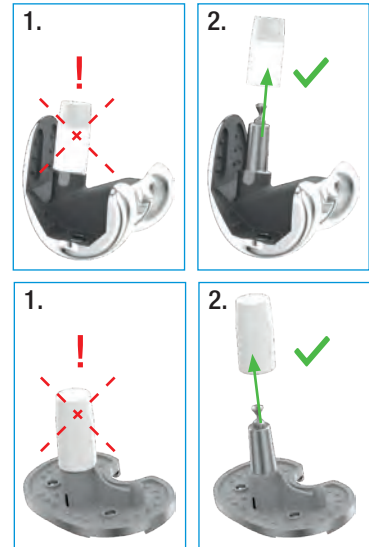

95

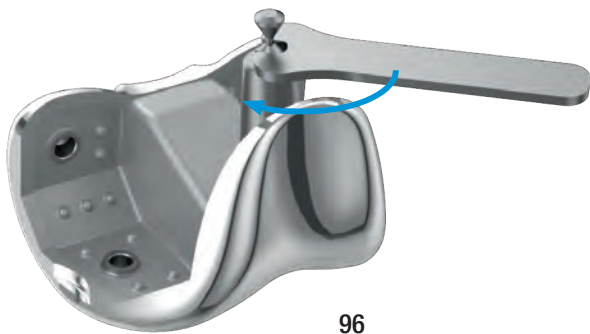

96



97

Select the final femoral and tibial stem, referencing to the ones used for the Trial Assembly.

If an Offset Stem is used, insert the male end of the Femoral or Tibial component into the female Offset Stem taper. Referencing the Trial Assembly, align the orientation lines to the appropriate setting (98 & 99).



98



99

Instruments



445-207/00
Impactor/Extractor
Handle



881-040/99
Tibial Femoral Coupling Base Tip



151-131/00
Screwdriver for Cone Adapter

ATTENTION: To avoid a metal on metal contact between the Stem and the Hammer, use the Tibial/Femoral Coupling Base Tip.

Connect the Tibial/Femoral Coupling Base Tip with the Impactor/Extractor Handle (100).

Slide the Tibial/Femoral Coupling Base Tip onto the top of the Stem.

Two Hammer blows are enough (101 & 102).

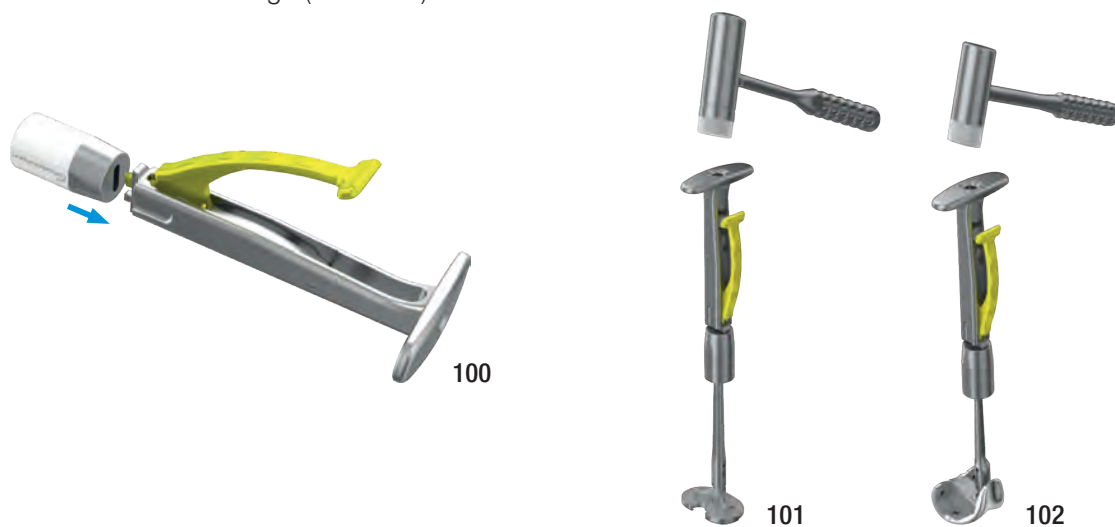

Secure the Security Screw for the Cone Adapter with the Torque Wrench (hex 2.5 mm) (103 & 104).

ATTENTION: The Security Screw is included in the package of the CCK Femoral Component and of the Modular Tibial Component.

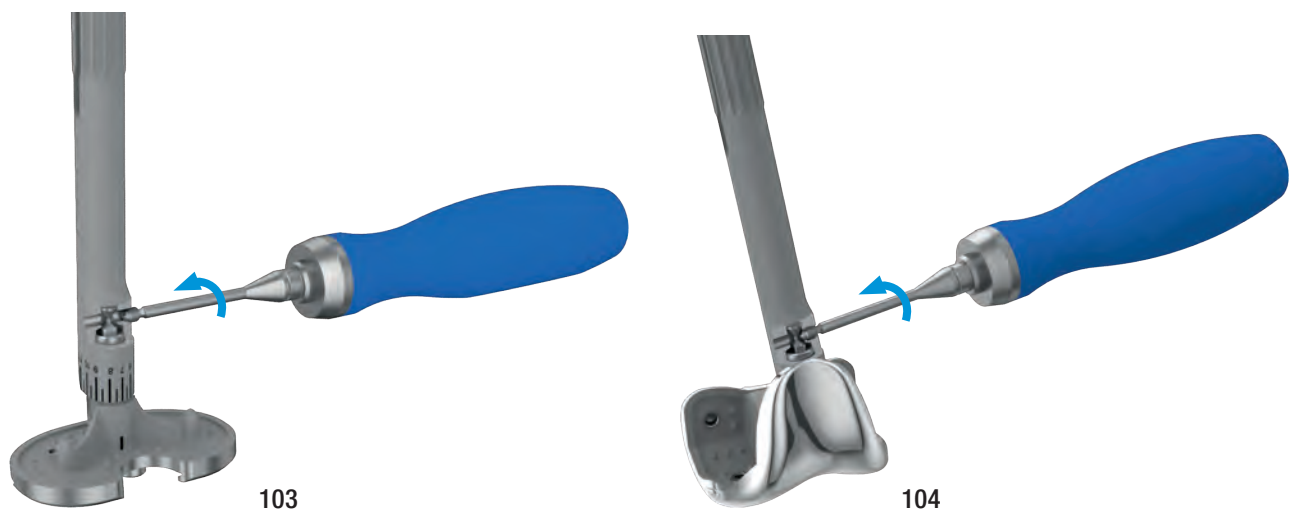

ATTENTION: If a Cemented Stem is used, assemble a Centralizer to the final stem. The Centralizer ensures a central positioning of the stem in the femoral/tibial canal and it avoids stress peaks in the bone in case of bending load.

Instruments



445-207/00
Impactor/Extractor
Handle



881-040/99
Tibial Femoral Coupling Base Tip



15-2545
Torque Wrench, hex 2.5 mm

Implantation

The implantation sequence:

- 1 Fixed Bearing Modular Tibial Component Implantation
- 2 CCK Femoral Component Implantation
- 3 CCK PE Articulating Surface Implantation
- 4 Patella Implantation

1 Fixed Bearing Tibial Component Implantation

Prepare the sclerotic bone to ensure a continuous cement mantle with good cement interdigitation of 2 mm - 4 mm. This can be done by drilling holes and cleansing the bone with Pulsatile Lavage.

The bone cement is prepared following the specific manufacturer's instructions. Apply a layer of bone cement to the underside of the Tibial Component, to the bone, or both.

Attach the Tibial Inserter to the fixed bearing tibial implant (105).

Carefully insert the Fixed Bearing Tibial Component, avoiding malrotation and impact into place (105).

If needed, the Tibial Impactor Tip, assembled with the Impactor/Extractor Handle (106), can be used to complete the seating of the component (107).

Complete implantation with several hammer blows to the top of Tibial Impactor assembly. Then use a Curette to remove all extruded cement.

ATTENTION: Ensure that excess bone cement is completely removed and no loose bone cement particles remain, especially in the posterior part of the joint.

OPTIONAL:
Attachment for the
Quick Connect Handle



Instruments



881-042/00
Tibial Inserter



445-207/00
Impactor/Extractor
Handle



881-042/99
Tibial Impactor Tip

2 CCK Femoral Component Implantation

The bone cement is prepared following the specific manufacturer's instructions. Apply a layer of bone cement to the backside of the Femoral Component, to the bone, or both. Place the selected Femoral Component onto the bone by hand or, if preferred, use the Femoral Inserter/Extractor. Deliver several hammer blows to the Femoral Inserter/Extractor (**108**).

Release the Femoral Inserter/Extractor and use the Femoral Impactor Tip (assembled to the Impactor/Extractor Handle (**109**) to complete the component impaction (**110**). Then use a Curette to remove all extruded cement.

ATTENTION: Ensure that excess bone cement is completely removed and no loose bone cement particles remain, especially in the posterior part of the joint.

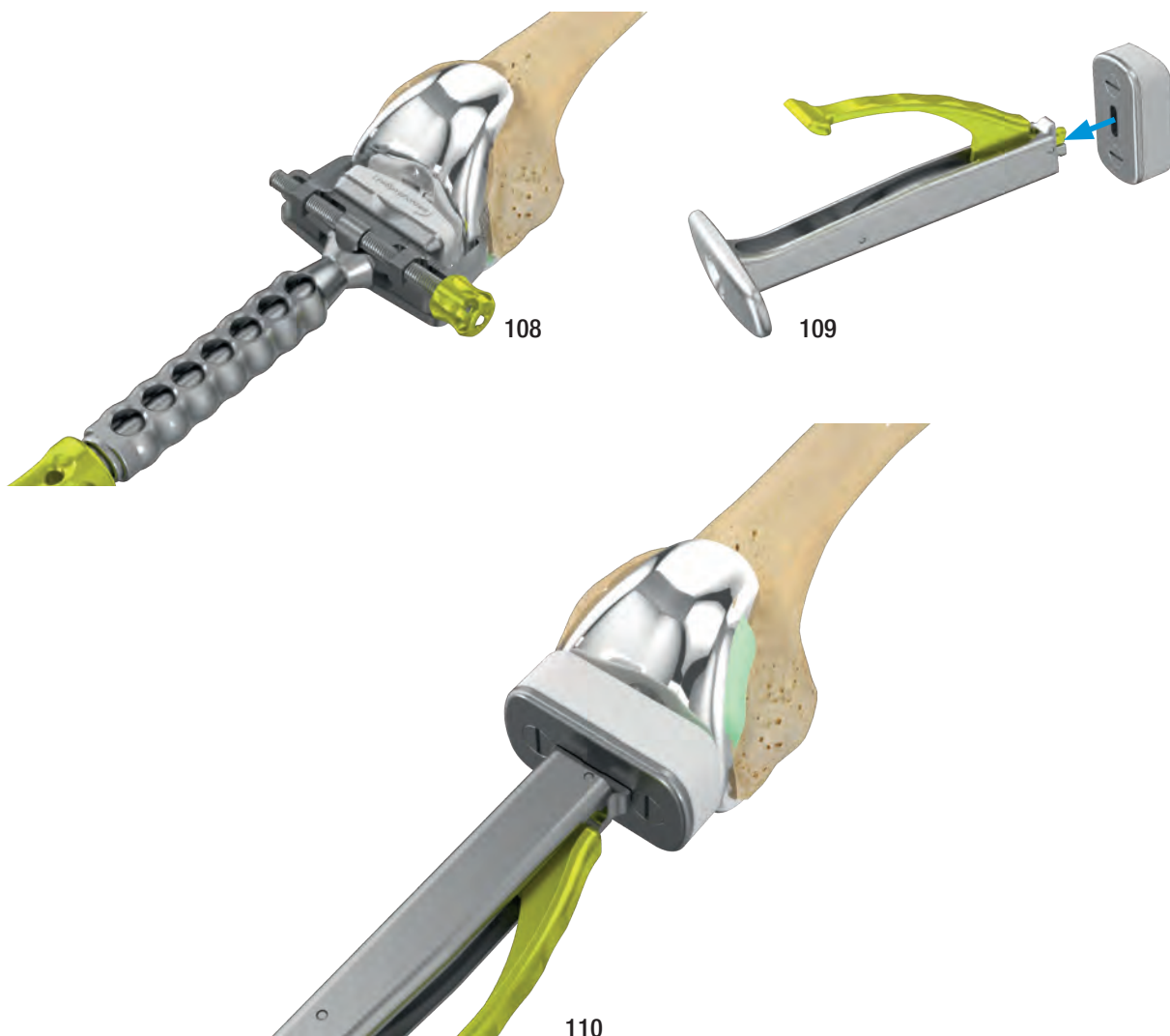

Instruments



445-207/00
Impactor/Extractor
Handle



881-041/00
Femoral
Inserter/Extractor



881-041/99
Femoral Impactor Tip

3 CCK PE Articulating Surface Implantation

Select the appropriate size of the CCK PE Articulating Surface.

The following table shows the possible *LinkSymphoKnee* size combinations:

		CCK Femoral Component										
		0	1	2	3/3+	4/4+	5/5+	6	7	8	9	10
Tibial Component	1	CCK Articulating Surface 1-2			CCK Articulating Surface 1-2up		x	x	x	x	x	x
	2	CCK Articulating Surface 1-2			CCK Articulating Surface 1-2up		x	x	x	x	x	x
	3	x	CCK Articulating Surface 3-4down		CCK Articulating Surface 3-4				x	x	x	x
	4	x	CCK Articulating Surface 3-4down		CCK Articulating Surface 3-4				x	x	x	x
	5	x	x	x	CCK Articulating Surface 5-6						x	x
	6	x	x	x	CCK Articulating Surface 5-6						x	x
	7	x	x	x	x	x	CCK Articulating Surface 7-8					
	8	x	x	x	x	x	CCK Articulating Surface 7-8					
	9	x	x	x	x	x	x	x	CCK Articulating Surface 9-10			
	10	x	x	x	x	x	x	x	CCK Articulating Surface 9-10			

Symbol Description: x = Combination not permitted

Select the appropriate thickness of the Fixed Bearing PE Articulating Surface.

Ensure that the Fixed Bearing PE Articulating Surface is pushed as far posteriorly as it will go before impaction (111). The PE posterior lip must rest beneath the posterior dovetail of the Tibial Component.

Impact anteriorly the Fixed Bearing PE Articulating Surface to snap it in place using the Articulating Surface Impactor (112). Remove all excess bone cement.

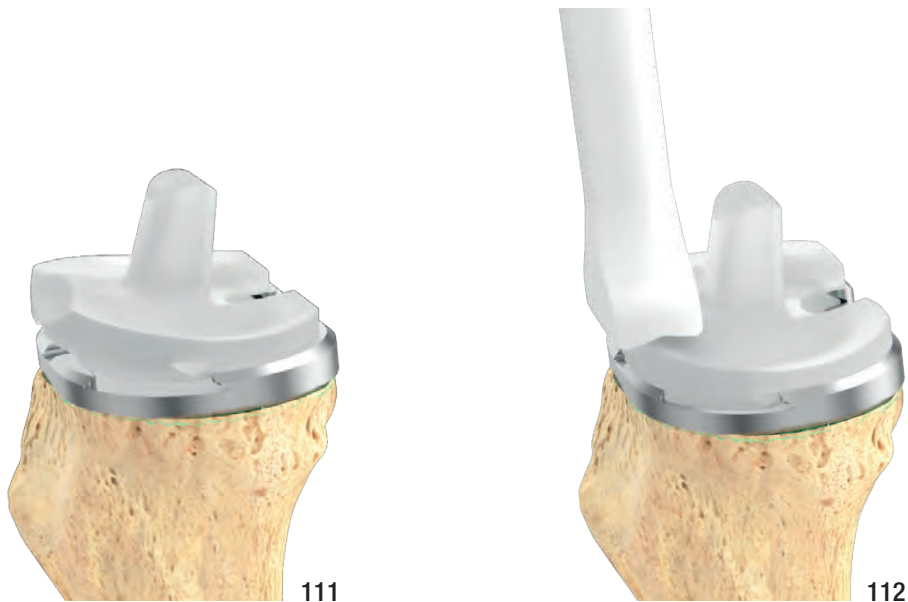

Instruments



881-040/01
Articulating Surface Impactor

4 Patella Implantation

Insert the Clamp Arm (F) into the first slot from the top of the Patella Clamp Handle (B) (113).

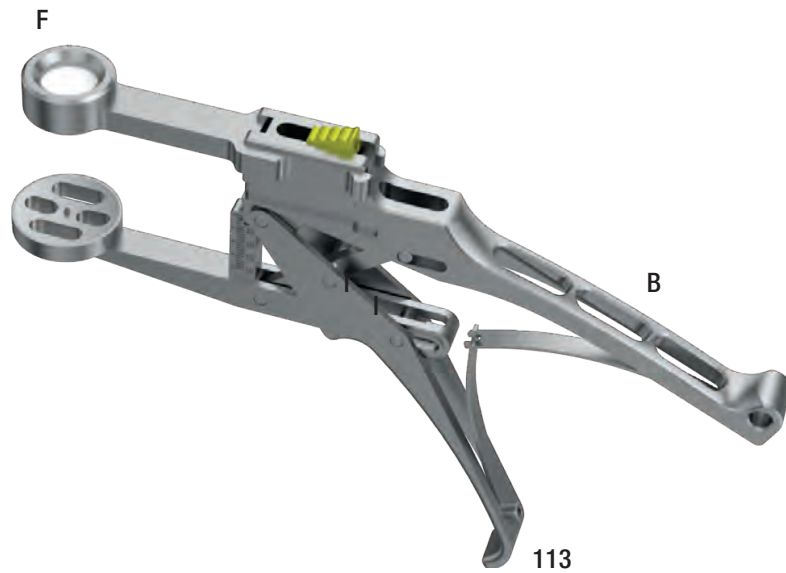

The bone cement is prepared following the specific manufacturer's instructions. Following extensive rinsing and removal of all impeding soft tissue, the bone cement is applied to the back of the implant, and the implant is placed by hand and pressed on using the Patella Clamp Handle with the Clamp Arm (114).

ATTENTION: Ensure that excess bone cement is completely removed and no loose bone cement particles remain in the joint.

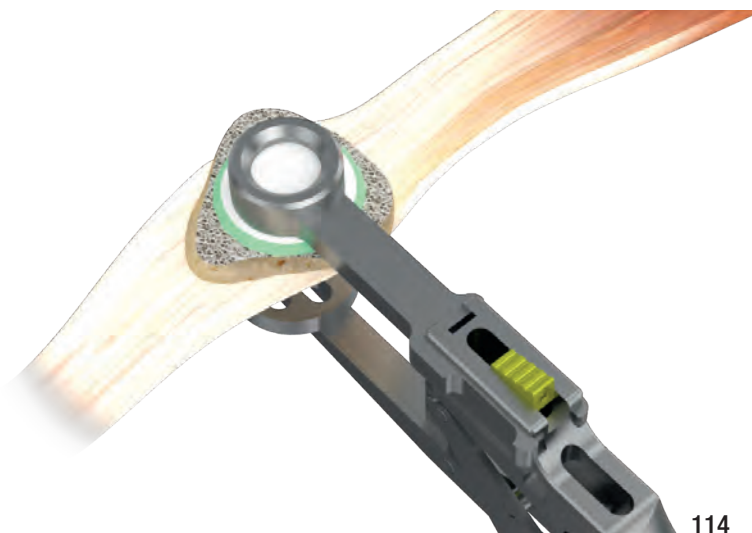

Instruments



445-902/00
Patella Clamp,
Handle



445-904/00
Patella Clamp, Arm

Functional Test

Perform a final functional test through an entire range of motion to check that all components are properly positioned, and also to check for proper ligament tension and patella tracking (115).



LinkSymphoKnee CCK

Appendix 1, Implant Removal

Articulating Surface removal

Use the Articulating Surface Extractor to disengage the PE Articulating Surface from the Tibial Component (116).

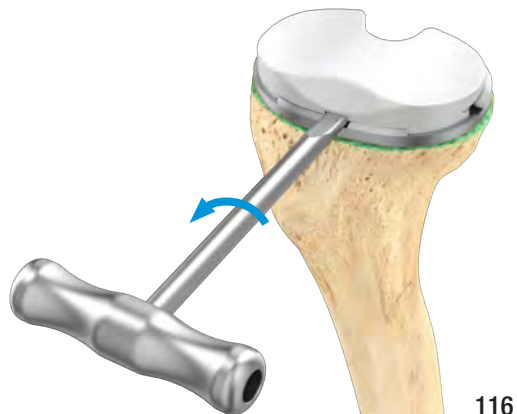

Femoral Component removal

Assemble the Slaphammer to the Femoral Inserter/Extractor and use it to extract the Femoral Component (117).

ATTENTION: Disrupt cement along the bone interface with flexible osteotomes or thin saw blades with an oscillating saw.

NOTE: In the case of a porous component, disrupt the bone/implant interface by using a Gigli saw, the thin blade of a reciprocating saw or flexible osteotomes.

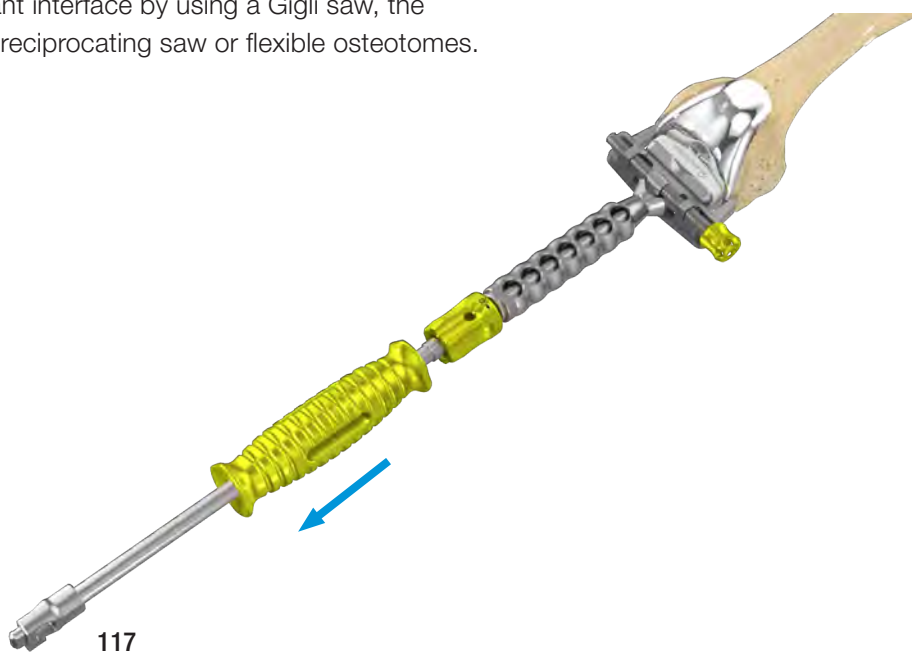

Instruments



445-206/00
Slaphammer



881-019/00
Articulating Surface Extractor



881-041/00
Femoral
Inserter/Extractor

Tibial Component removal

Assemble the Slaphammer to the Tibial Extractor Tip and use it to extract the Tibial Component (118). Make sure that the Slaphammer is fully threaded into the Tibial Extractor Tip, before using the retrograded impactor.

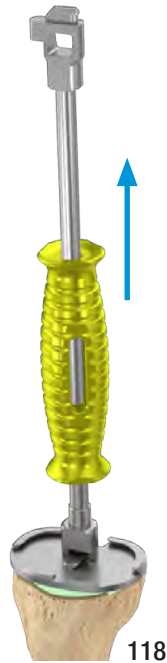

Stem removal

If the Stem remains in situ, remove all the cement from the noses of the Stem and from the top of the female taper (119)

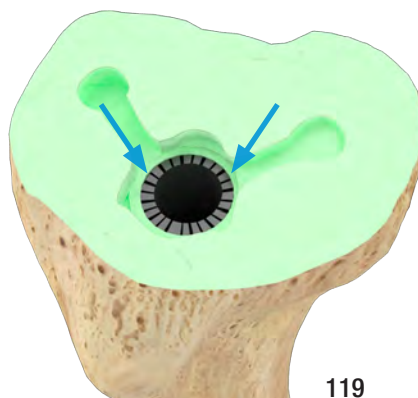

Instruments



445-206/00
Slaphammer



881-043/00
Tibial Extractor Tip

Assemble the male taper of the Stem Extractor into the female taper of the stem.

ATTENTION: Clean the female taper before inserting the Stem Extractor.

ATTENTION: The peg of the Stem Extractor (121) must be on the same side as the marking on the top of the Stem female taper (120).

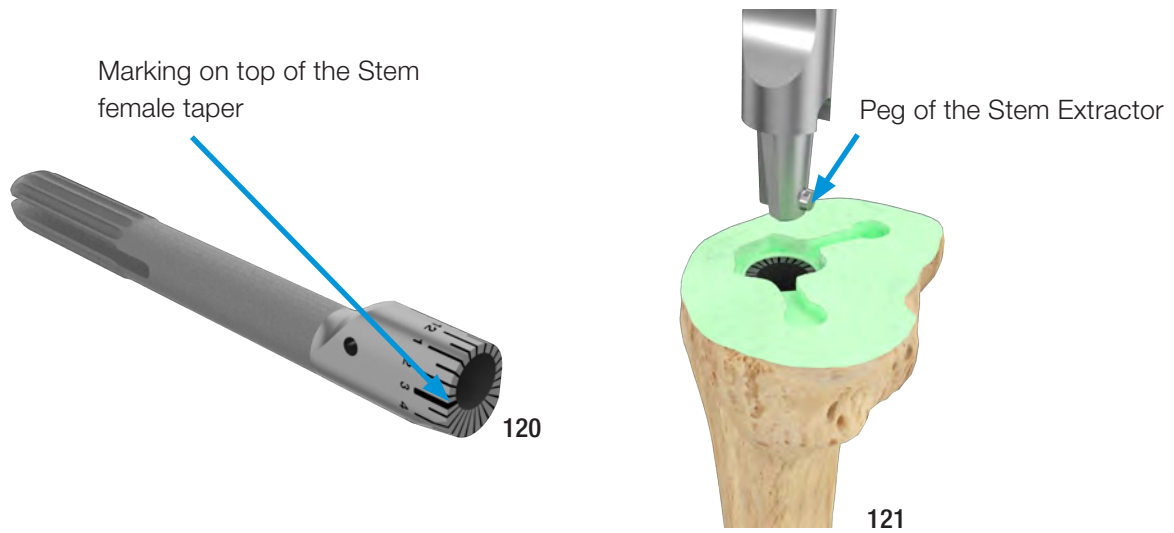

Assemble the Slaphammer onto the Stem Extractor and use it to remove the Stem (122).



Instruments



445-206/00
Slaphammer



151-144/00
Extractor for Modular
Stems/Offset Stems

Appendix 2, Extraction Stem Adapter and Trial Stems:

OPTIONAL: If the Trial Stem Adapter and the Trial Stem remain inside the bone during the extraction of the trial components (femoral and/or tibial), it is possible to use the Slaphammer to extract them. Attach the Modular Extractor Tip to the Slaphammer (123).

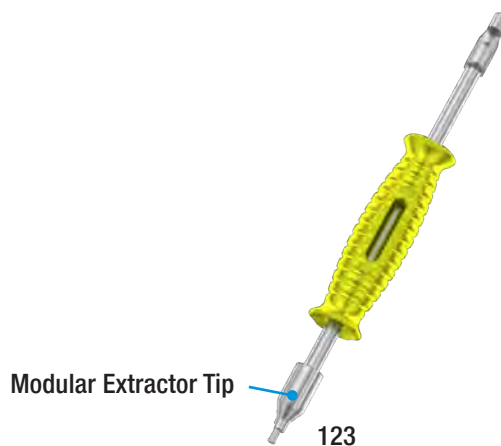

Connect the Modular Extractor Tip with the Stem Adapter (124).

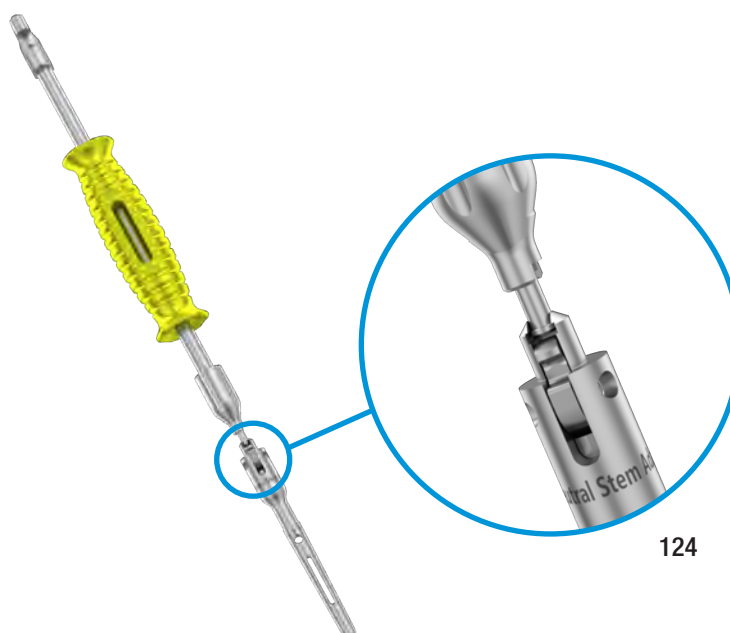

Use the Slaphammer to axially remove the Stem Adapter and the Trial Stem.

Instruments



151-132/00
Modular Extractor Tip



151-716/16
Trial Stem, cementless,
cylindrical, Ø 16 mm



445-206/00
Slaphammer



151-501/00
Neutral Stem Adapter

Appendix 3, TrabecuLink Cones Compatibility

The *LinkSymphoKnee* CCK Modular Tibial Components are compatible with the TrabecuLink Tibial Cones, respectively (125).



125

Select the appropriate size of the TrabecuLink Tibial Cone according to the following table:

Tibial Cones all versions	Tibial Components									
	1	2	3	4	5	6	7	8	9	10
XS	x	x	x	x	x	x	x	x	x	x
S	✓	✓	x	x	x	x	x	x	x	x
M	x	x	✓	✓	x	x	x	x	x	x
L	x	x	x	x	✓	✓	x	x	x	x

For all TrabecuLink Cones Implants and Instruments information, refer to the TrabecuLink Cones Surgical Technique.

LinkSymphoKnee

Implants Combination Overview

Patella



Additional Implants

Femoral Components



CR

Articulating Surfaces

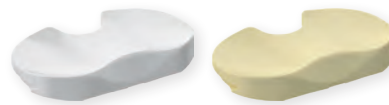

CR

Tibial Components



Not modular

Additional Implants

In the following pages are listed and described all implants and instruments for the CCK configurations.

For all other implants and instruments, refer to the *LinkSymphoKnee* CR, PS, PS+ Surgical Technique.

Modular Stems and Femoral Augments

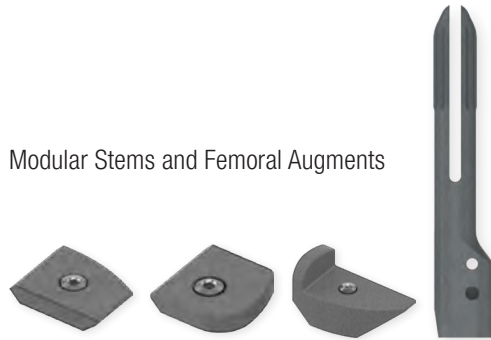

PS

CCK

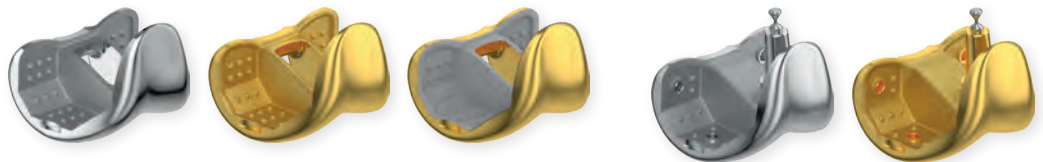

PS

PS+

CCK

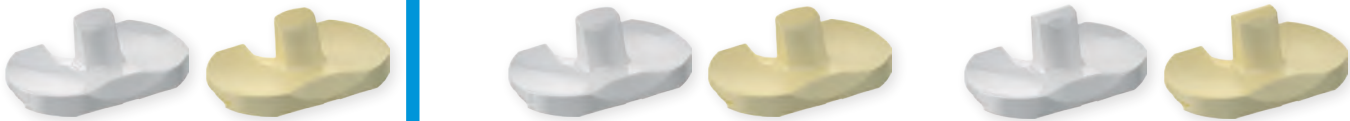

PS All-Poly

Modular

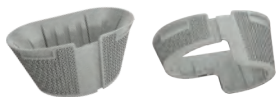

TrabecuLink Tibial Cones

Modular Stems and Tibial Augments



LinkSymphoKnee Femoral Components – CCK Micro-Sizes

cemented

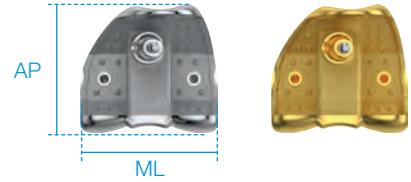

REF MAT CoCrMo	REF MAT CoCrMo LINK PorEx*	Size	Side	AP mm	ML mm
880-030/00	880-080/00	0	right	47	53.5
880-030/10	880-080/10	1	right	50	56
880-030/20	880-080/20	2	right	53	58.5
880-031/00	880-081/00	0	left	47	53.5
880-031/10	880-081/10	1	left	50	56
880-031/20	880-081/20	2	left	53	58.5

LinkSymphoKnee Femoral Components – CCK

cemented

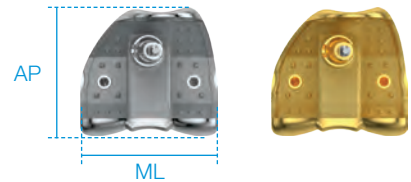

REF MAT CoCrMo	REF MAT CoCrMo LINK PorEx*	Size	Side	AP mm	ML mm
880-030/30	880-080/30	3	right	56	61
880-030/40	880-080/40	4	right	59	63.5
880-030/50	880-080/50	5	right	62	66
880-030/60	880-080/60	6	right	65	69
880-030/70	880-080/70	7	right	68	72
880-030/80	880-080/80	8	right	71	75
880-031/30	880-081/30	3	left	56	61
880-031/40	880-081/40	4	left	59	63.5
880-031/50	880-081/50	5	left	62	66
880-031/60	880-081/60	6	left	65	69
880-031/70	880-081/70	7	left	68	72
880-031/80	880-081/80	8	left	71	75

* LINK PorEx: TiNbN = Titanium Niobium Nitride (gold color).
 ** Cone Adapter made of Tilastan = Ti6Al4V

LinkSymphoKnee Femoral Components – CCK Macro-Sizes

cemented

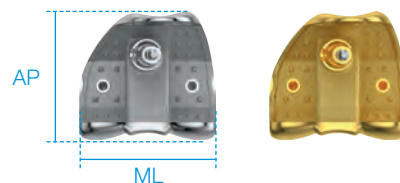

REF MAT CoCrMo	REF MAT CoCrMo LINK PorEx*	Size	Side	AP mm	ML mm
880-030/90	880-080/90	9	right	74	78
880-030/X0	880-080/X0	10	right	77	81
880-031/90	880-081/90	9	left	74	78
880-031/X0	880-081/X0	10	left	77	81

LinkSymphoKnee Femoral Components – CCK Wide-Sizes

cemented

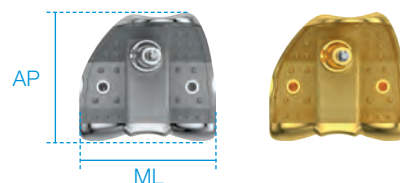

REF MAT CoCrMo	REF MAT CoCrMo LINK PorEx*	Size	Side	AP mm	ML mm
880-030/35	880-080/35	3+	right	56	63.5
880-030/45	880-080/45	4+	right	59	66
880-030/55	880-080/55	5+	right	62	69
880-031/35	880-081/35	3+	left	56	63.5
880-031/45	880-081/45	4+	left	59	66
880-031/55	880-081/55	5+	left	62	69

* LINK PorEx: TiNbN = Titanium Niobium Nitride (gold color).
 ** Cone Adapter made of Tilastan = Ti6Al4V

LinkSymphoKnee Tibial Components – Modular Micro-Sizes

cemented				
REF	REF	Size	AP mm	ML mm
MAT CoCrMo	MAT CoCrMo LINK PorEx*			
880-050/10	880-100/10	1	37.5	59
880-050/20	880-100/20	2	40	62.5

LinkSymphoKnee Tibial Components – Modular

cemented				
REF	REF	Size	AP mm	ML mm
MAT CoCrMo	MAT CoCrMo LINK PorEx*			
880-050/30	880-100/30	3	42.5	66
880-050/40	880-100/40	4	45	69.5
880-050/50	880-100/50	5	47.5	73
880-050/60	880-100/60	6	50	76.5
880-050/70	880-100/70	7	52.5	80
880-050/80	880-100/80	8	55	83.5

LinkSymphoKnee Tibial Components – Modular Macro-Sizes

cemented				
REF	REF	Size	AP mm	ML mm
MAT CoCrMo	MAT CoCrMo LINK PorEx*			
880-050/90	880-100/90	9	57.5	87
880-050/X0	880-100/X0	10	60	90.5

* LINK PorEx: TiNbN = Titanium Niobium Nitride (gold color).
 ** Cone Adapter made of Tilastan = Ti6Al4V

LinkSymphoKnee Articulating Surfaces – CCK Micro-Sizes

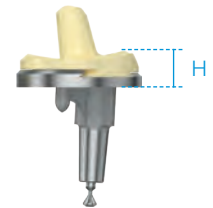
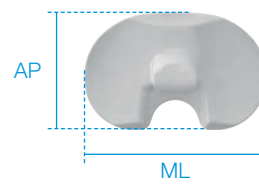
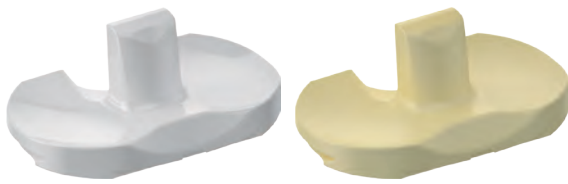

REF MAT UHMWPE	REF MAT E-Dur*	Size	AP mm	ML mm	Height (H) mm
880-231/10	880-271/10	1-2	37.5	59	10
880-231/12	880-271/12	1-2	37.5	59	12
880-231/14	880-271/14	1-2	37.5	59	14
880-231/16	880-271/16	1-2	37.5	59	16
880-231/18	880-271/18	1-2	37.5	59	18
880-231/20	880-271/20	1-2	37.5	59	20
880-231/22	880-271/22	1-2	37.5	59	22
880-231/24	880-271/24	1-2	37.5	59	24
880-232/10	880-272/10	1-2up	37.5	59	10
880-232/12	880-272/12	1-2up	37.5	59	12
880-232/14	880-272/14	1-2up	37.5	59	14
880-232/16	880-272/16	1-2up	37.5	59	16
880-232/18	880-272/18	1-2up	37.5	59	18
880-232/20	880-272/20	1-2up	37.5	59	20
880-232/22	880-272/22	1-2up	37.5	59	22
880-232/24	880-272/24	1-2up	37.5	59	24

* E-Dur = Highly crosslinked UHMWPE (X-Linked PE) with Vit-E

LinkSymphoKnee Articulating Surfaces – CCK

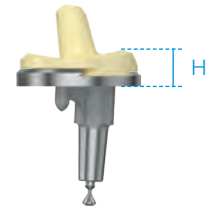
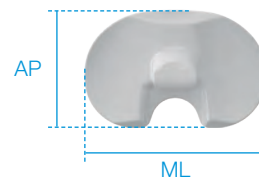

REF MAT UHMWPE	REF MAT E-Dur *	Size	AP mm	ML mm	Height (H) mm
880-233/10	880-273/10	3-4	42.5	66	10
880-233/12	880-273/12	3-4	42.5	66	12
880-233/14	880-273/14	3-4	42.5	66	14
880-233/16	880-273/16	3-4	42.5	66	16
880-233/18	880-273/18	3-4	42.5	66	18
880-233/20	880-273/20	3-4	42.5	66	20
880-233/22	880-273/22	3-4	42.5	66	22
880-233/24	880-273/24	3-4	42.5	66	24
880-234/10	880-274/10	3-4down	42.5	66	10
880-234/12	880-274/12	3-4down	42.5	66	12
880-234/14	880-274/14	3-4down	42.5	66	14
880-234/16	880-274/16	3-4down	42.5	66	16
880-234/18	880-274/18	3-4down	42.5	66	18
880-234/20	880-274/20	3-4down	42.5	66	20
880-234/22	880-274/22	3-4down	42.5	66	22
880-234/24	880-274/24	3-4down	42.5	66	24
880-235/10	880-275/10	5-6	47.5	73	10
880-235/12	880-275/12	5-6	47.5	73	12
880-235/14	880-275/14	5-6	47.5	73	14
880-235/16	880-275/16	5-6	47.5	73	16
880-235/18	880-275/18	5-6	47.5	73	18
880-235/20	880-275/20	5-6	47.5	73	20
880-235/22	880-275/22	5-6	47.5	73	22
880-235/24	880-275/24	5-6	47.5	73	24
880-237/10	880-277/10	7-8	52.5	80	10
880-237/12	880-277/12	7-8	52.5	80	12
880-237/14	880-277/14	7-8	52.5	80	14
880-237/16	880-277/16	7-8	52.5	80	16
880-237/18	880-277/18	7-8	52.5	80	18
880-237/20	880-277/20	7-8	52.5	80	20
880-237/22	880-277/22	7-8	52.5	80	22
880-237/24	880-277/24	7-8	52.5	80	24

LinkSymphoKnee Articulating Surfaces – CCK Macro-Sizes

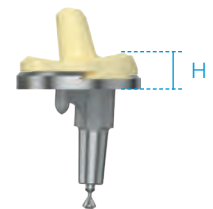

REF MAT UHMWPE	REF MAT E-Dur *	Size	AP mm	ML mm	Height (H) mm
880-239/10	880-279/10	9-10	57.5	87	10
880-239/12	880-279/12	9-10	57.5	87	12
880-239/14	880-279/14	9-10	57.5	87	14
880-239/16	880-279/16	9-10	57.5	87	16
880-239/18	880-279/18	9-10	57.5	87	18
880-239/20	880-279/20	9-10	57.5	87	20
880-239/22	880-279/22	9-10	57.5	87	22
880-239/24	880-279/24	9-10	57.5	87	24

* E-Dur = Highly crosslinked UHMWPE (X-Linked PE) with Vit-E

LinkSymphoKnee – Cylindrical Press-Fit Stems

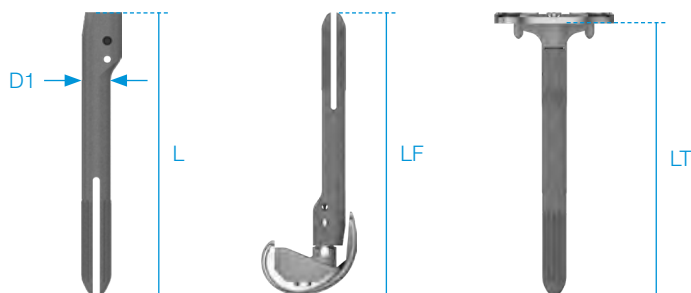

REF Straight MAT Tilastan*	REF 3 mm Offset MAT Tilastan*	REF 6 mm Offset MAT Tilastan*	D1 mm	L mm	LF mm	LT mm
880-601/10	880-611/10	880-621/10	10	80	115	98
880-601/11	880-611/11	880-621/11	11	80	115	98
880-601/12	880-611/12	880-621/12	12	80	115	98
880-601/13	880-611/13	880-621/13	13	80	115	98
880-601/14	880-611/14	880-621/14	14	80	115	98
880-601/15	880-611/15	880-621/15	15	80	115	98
880-601/16	880-611/16	880-621/16	16	80	115	98
880-601/17	880-611/17	880-621/17	17	80	115	98
880-601/18	880-611/18	880-621/18	18	80	115	98
880-603/10	880-613/10	880-623/10	10	120	155	138
880-603/11	880-613/11	880-623/11	11	120	155	138
880-603/12	880-613/12	880-623/12	12	120	155	138
880-603/13	880-613/13	880-623/13	13	120	155	138
880-603/14	880-613/14	880-623/14	14	120	155	138
880-603/15	880-613/15	880-623/15	15	120	155	138
880-603/16	880-613/16	880-623/16	16	120	155	138
880-603/17	880-613/17	880-623/17	17	120	155	138
880-603/18	880-613/18	880-623/18	18	120	155	138
880-603/19	880-613/19	880-623/19	19	120	155	138
880-603/20	880-613/20	880-623/20	20	120	155	138
880-605/11	880-615/11	880-625/11	11	160	195	178
880-605/12	880-615/12	880-625/12	12	160	195	178
880-605/13	880-615/13	880-625/13	13	160	195	178
880-605/14	880-615/14	880-625/14	14	160	195	178
880-605/15	880-615/15	880-625/15	15	160	195	178
880-605/16	880-615/16	880-625/16	16	160	195	178
880-605/17	880-615/17	880-625/17	17	160	195	178
880-605/18	880-615/18	880-625/18	18	160	195	178
880-605/19	880-615/19	880-625/19	19	160	195	178
880-605/20	880-615/20	880-625/20	20	160	195	178
880-607/12	880-617/12	880-627/12	12	200	235	218
880-607/14	880-617/14	880-627/14	14	200	235	218
880-607/16	880-617/16	880-627/16	16	200	235	218
880-607/18	880-617/18	880-627/18	18	200	235	218
880-607/20	880-617/20	880-627/20	20	200	235	218
880-607/22	880-617/22	880-627/22	22	200	235	218
880-608/12	880-618/12	880-628/12	12	220	255	238
880-608/14	880-618/14	880-628/14	14	220	255	238
880-608/16	880-618/16	880-628/16	16	220	255	238
880-608/18	880-618/18	880-628/18	18	220	255	238
880-608/20	880-618/20	880-628/20	20	220	255	238
880-608/22	880-618/22	880-628/22	22	220	255	238
880-609/12	880-619/12	880-629/12	12	240	275	258
880-609/14	880-619/14	880-629/14	14	240	275	258
880-609/16	880-619/16	880-629/16	16	240	275	258
880-609/18	880-619/18	880-629/18	18	240	275	258
880-609/20	880-619/20	880-629/20	20	240	275	258
880-609/22	880-619/22	880-629/22	22	240	275	258

* Tilastan = Ti6Al4V

LinkSymphoKnee – Conical Cemented Stems

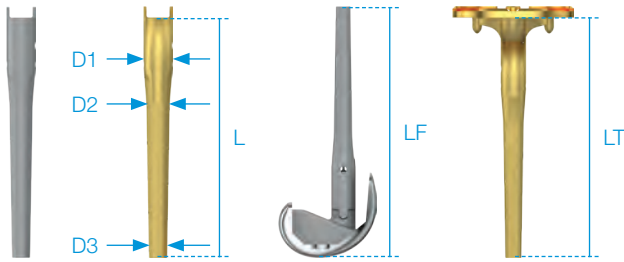

REF MAT CoCrMo	REF MAT CoCrMo/ LINK PorEx*	REF 3 mm Offset MAT CoCrMo	REF 3 mm Offset MAT CoCrMo/ LINK PorEx*	REF 6 mm Offset MAT CoCrMo	REF 6 mm Offset MAT CoCrMo/ LINK PorEx*	D1 mm	D2 mm	D3 mm	L mm	LF mm	LT mm
15-2950/17	15-3950/17					16	11	8	50	85	68
15-2950/12	15-3950/12	15-4302/08	15-5302/08	15-4602/08	15-5602/08	16	10	7	80	115	98
15-2950/18	15-3950/18	15-4304/08	15-5304/08	15-4604/08	15-5604/08	16	11	8	80	115	98
15-2950/27	15-3950/27	15-4305/08	15-5305/08	15-4605/08	15-5605/08	16	13	10	80	115	98
15-2950/36	15-3950/36	15-4306/08	15-5306/08	15-4606/08	15-5606/08	16	15	12	80	115	98
15-2950/13	15-3950/13					16	10	7	95	130	113
15-2950/19	15-3950/19					16	11	8	95	130	113
15-2950/28	15-3950/28					16	13	10	95	130	113
15-2950/37	15-3950/37					16	15	12	95	130	113
15-2950/14	15-3950/14	15-4302/12	15-5302/12	15-4602/12	15-5602/12	16	10	7	120	155	138
15-2950/20	15-3950/20	15-4304/12	15-5304/12	15-4604/12	15-5604/12	16	11	8	120	155	138
15-2950/29	15-3950/29	15-4305/12	15-5305/12	15-4605/12	15-5605/12	16	13	10	120	155	138
15-2950/38	15-3950/38	15-4306/12	15-5306/12	15-4606/12	15-5606/12	16	15	12	120	155	138
15-2950/15	15-3950/15					16	10	7	135	170	153
15-2950/21	15-3950/21					16	11	8	135	170	153
15-2950/30	15-3950/30					16	13	10	135	170	153
15-2950/39	15-3950/39					16	15	12	135	170	153
15-2950/16	15-3950/16	15-4302/16	15-5302/16	15-4602/16	15-5602/16	16	10	7	160	195	178
15-2950/22	15-3950/22	15-4304/16	15-5304/16	15-4604/16	15-5604/16	16	11	8	160	195	178
15-2950/31	15-3950/31	15-4305/16	15-5305/16	15-4605/16	15-5605/16	16	13	10	160	195	178
15-2950/40	15-3950/40	15-4306/16	15-5306/16	15-4606/16	15-5606/16	16	15	12	160	195	178
15-2950/44	15-3950/44	15-4304/18	15-5304/18	15-4604/18	15-5604/18	16	11	8	180	215	198
15-2950/45	15-3950/45	15-4305/18	15-5305/18	15-4605/18	15-5605/18	16	13	10	180	215	198
15-2950/46	15-3950/46	15-4306/18	15-5306/18	15-4606/18	15-5606/18	16	15	12	180	215	198
15-2950/23	15-3950/23					16	11	8	200	235	218
15-2950/32	15-3950/32					16	13	10	200	235	218
15-2950/41	15-3950/41					16	15	12	200	235	218
15-2950/24	15-3950/24	15-4304/24	15-5304/24	15-4604/24	15-5604/24	16	11	8	240	275	258
15-2950/33	15-3950/33	15-4305/24	15-5305/24	15-4605/24	15-5605/24	16	13	10	240	275	258
15-2950/42	15-3950/42	15-4306/24	15-5306/24	15-4606/24	15-5606/24	16	15	12	240	275	258
15-2950/25	15-3950/25					16	11	8	280	315	298
15-2950/34	15-3950/34					16	13	10	280	315	298
15-2950/43	15-3950/43					16	15	12	280	315	298

LinkSymphoKnee – Centralizers

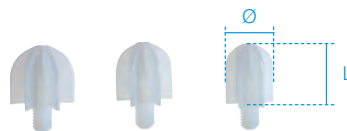

REF MAT UHMWPE	Ø mm	Length (L) mm
15-2975/12	12	15
15-2975/14	14	15
15-2975/16	16	15
15-2975/18	18	15
15-2975/20	20	15
15-2975/22	22	15
15-2975/24	24	15

* LINK PorEx: TiNbN = Titanium Niobium Nitride (gold color).

LinkSymphoKnee – Cylindrical Cementless Stems



REF MAT Tilastan*	REF 3 mm Offset MAT Tilastan*	REF 6 mm Offset MAT Tilastan*	D1 mm	D2 mm	D3 mm	L mm	LF mm	LT mm
15-2951/43	15-4310/08	15-4610/08	16	10	10	80	115	98
15-2951/44	15-4311/08	15-4611/08	16	11	11	80	115	98
15-2951/45	15-4312/08	15-4612/08	16	12	12	80	115	98
15-2951/46	15-4313/08	15-4613/08	16	13	13	80	115	98
15-2951/47	15-4314/08	15-4614/08	16	14	14	80	115	98
15-2951/48	15-4315/08	15-4615/08	16	15	15	80	115	98
15-2951/49	15-4316/08	15-4616/08	16	16	16	80	115	98
15-2951/50	15-4317/08	15-4617/08	17	17	17	80	115	98
15-2951/51	15-4318/08	15-4618/08	18	18	18	80	115	98
15-2951/54	15-4310/12	15-4610/12	16	10	10	120	155	138
15-2951/55	15-4311/12	15-4611/12	16	11	11	120	155	138
15-2951/72	15-4312/12	15-4612/12	16	12	12	120	155	138
15-2951/56	15-4313/12	15-4613/12	16	13	13	120	155	138
15-2951/78	15-4314/12	15-4614/12	16	14	14	120	155	138
15-2951/57	15-4315/12	15-4615/12	16	15	15	120	155	138
15-2951/84	15-4316/12	15-4616/12	16	16	16	120	155	138
15-2951/58	15-4317/12	15-4617/12	17	17	17	120	155	138
15-2951/90	15-4318/12	15-4618/12	18	18	18	120	155	138
15-2951/59	15-4319/12	15-4619/12	19	19	19	120	155	138
15-2951/60	15-4320/12	15-4620/12	20	20	20	120	155	138
15-2951/63	15-4311/16	15-4611/16	16	11	11	160	195	178
15-2951/73	15-4312/16	15-4612/16	16	12	12	160	195	178
15-2951/64	15-4313/16	15-4613/16	16	13	13	160	195	178
15-2951/79	15-4314/16	15-4614/16	16	14	14	160	195	178
15-2951/65	15-4315/16	15-4615/16	16	15	15	160	195	178
15-2951/85	15-4316/16	15-4616/16	16	16	16	160	195	178
15-2951/66	15-4317/16	15-4617/16	17	17	17	160	195	178
15-2951/91	15-4318/16	15-4618/16	18	18	18	160	195	178
15-2951/67	15-4319/16	15-4619/16	19	19	19	160	195	178
15-2951/68	15-4320/16	15-4620/16	20	20	20	160	195	178
15-2951/74			16	12	12	200	235	218
15-2951/80			16	14	14	200	235	218
15-2951/86			16	16	16	200	235	218
15-2951/92			18	18	18	200	235	218
15-2951/75			16	12	12	240	275	258
15-2951/81			16	14	14	240	275	258
15-2951/87			16	16	16	240	275	258
15-2951/93			18	18	18	240	275	258

* Tilastan = Ti6Al4V

LinkSymphoKnee – Conical Cementless Stems

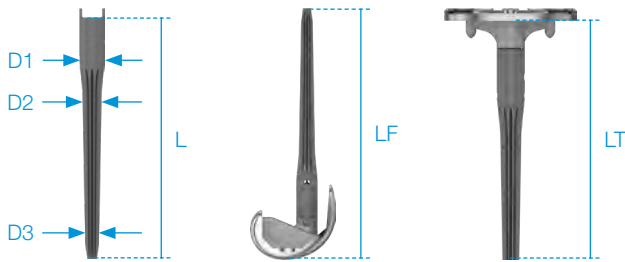

REF	D1 mm	D2 mm	D3 mm	L mm	LF mm	LT mm
MAT Tilastan*						
15-2953/00	16	12	9	128	95	78
15-2953/01	16	13	10	128	95	78
15-2953/02	16	14	11	128	95	78
15-2953/03	16	15	12	128	95	78
15-2953/04	16	16	13	128	95	78
15-2953/05	17	17	14	128	95	78
15-2953/06	18	18	15	128	95	78
15-2953/07	19	19	16	128	95	78
15-2953/08	20	20	17	128	95	78
15-2953/09	21	21	18	128	95	78
15-2953/10	22	22	19	128	95	78
15-2953/11	23	23	20	128	115	98
15-2953/12	24	24	21	128	115	98
15-2954/00	16	12	9	158	115	98
15-2954/01	16	13	10	158	115	98
15-2954/02	16	14	11	158	115	98
15-2954/03	16	15	12	158	115	98
15-2954/04	16	16	13	158	115	98
15-2954/05	17	17	14	158	115	98
15-2954/06	18	18	15	158	115	98
15-2954/07	19	19	16	158	115	98
15-2954/08	20	20	17	158	115	98
15-2954/09	21	21	18	158	155	138
15-2954/10	22	22	19	158	155	138
15-2954/11	23	23	20	158	155	138
15-2954/12	24	24	21	158	155	138
15-2958/00	16	12	9	188	155	138
15-2958/01	16	13	10	188	155	138
15-2958/02	16	14	11	188	155	138
15-2958/03	18	15	12	188	155	138
15-2958/04	16	16	13	188	155	138
15-2958/05	17	17	14	188	155	138
15-2958/06	18	18	15	188	155	138
15-2958/07	19	19	16	188	155	138
15-2958/08	20	20	17	188	195	178
15-2958/09	21	21	18	188	195	178
15-2958/10	22	22	19	188	195	178
15-2958/11	23	23	20	188	195	178
15-2958/12	24	24	21	188	195	178

* Tilastan = Ti6Al4V

Replacement Sets for Cone Adapter



REF	REF
MAT Tilastan* + CoCrMo	MAT Tilastan* + CoCrMo/ LINK PorEx** LINK PorEx**
15-6118/29	15-6118/30

Each package contains:

- One Cone Adapter
- Two Security Screws

* Tilastan = Ti6Al4V
 ** LINK PorEx: TiNbN = Titanium Niobium Nitride (gold color).

LinkSymphoKnee Femoral Augments – Distal, Micro-Sizes

cemented



REF MAT Tilastan*	Size	Side	Height mm
880-300/11	0	Medial-Right/Lateral-Left	5
880-300/21	0	Lateral-Right/Medial-Left	5
880-301/11	1-2	Medial-Right/Lateral-Left	5
880-301/21	1-2	Lateral-Right/Medial-Left	5

LinkSymphoKnee Femoral Augments – Distal

cemented



REF MAT Tilastan*	Size	Side	Height mm
880-303/11	3-4	Medial-Right/Lateral-Left	5
880-303/12	3-4	Medial-Right/Lateral-Left	10
880-303/21	3-4	Lateral-Right/Medial-Left	5
880-303/22	3-4	Lateral-Right/Medial-Left	10
880-305/11	5-6	Medial-Right/Lateral-Left	5
880-305/12	5-6	Medial-Right/Lateral-Left	10
880-305/21	5-6	Lateral-Right/Medial-Left	5
880-305/22	5-6	Lateral-Right/Medial-Left	10
880-307/11	7-8	Medial-Right/Lateral-Left	5
880-307/12	7-8	Medial-Right/Lateral-Left	10
880-307/21	7-8	Lateral-Right/Medial-Left	5
880-307/22	7-8	Lateral-Right/Medial-Left	10

LinkSymphoKnee Femoral Augments – Distal, Macro-Sizes

cemented





REF MAT Tilastan*	Size	Side	Height mm
880-309/11	9-10	Medial-Right/Lateral-Left	5
880-309/12	9-10	Medial-Right/Lateral-Left	10
880-309/21	9-10	Lateral-Right/Medial-Left	5
880-309/22	9-10	Lateral-Right/Medial-Left	10

* Tilastan = Ti6Al4V

LinkSymphoKnee Femoral Augments – Posterior, Micro-Sizes

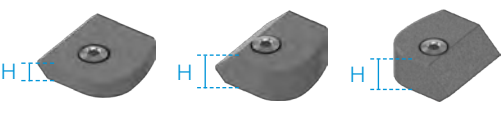

cemented

REF MAT Tilastan*	Size	Side	Height mm
880-310/11	0	Medial-Right/Lateral-Left	5
880-310/21	0	Lateral-Right/Medial-Left	5
880-311/11	1-2	Medial-Right/Lateral-Left	5
880-311/21	1-2	Lateral-Right/Medial-Left	5

LinkSymphoKnee Femoral Augments – Posterior

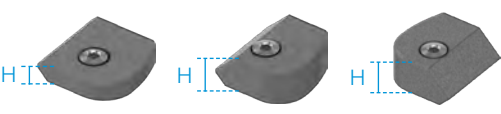

cemented

REF MAT Tilastan*	Size	Side	Height mm
880-313/11	3-4	Medial-Right/Lateral-Left	5
880-313/12	3-4	Medial-Right/Lateral-Left	10
880-313/21	3-4	Lateral-Right/Medial-Left	5
880-313/22	3-4	Lateral-Right/Medial-Left	10
880-315/11	5-6	Medial-Right/Lateral-Left	5
880-315/12	5-6	Medial-Right/Lateral-Left	10
880-315/21	5-6	Lateral-Right/Medial-Left	5
880-315/22	5-6	Lateral-Right/Medial-Left	10
880-317/11	7-8	Medial-Right/Lateral-Left	5
880-317/12	7-8	Medial-Right/Lateral-Left	10
880-317/21	7-8	Lateral-Right/Medial-Left	5
880-317/22	7-8	Lateral-Right/Medial-Left	10

LinkSymphoKnee Femoral Augments – Posterior, Macro-Sizes

cemented

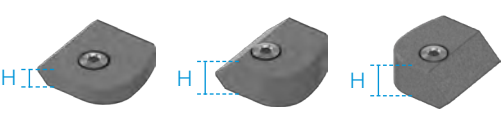
REF MAT Tilastan*	Size	Side	Height mm
880-319/11	9-10	Medial-Right/Lateral-Left	5
880-319/12	9-10	Medial-Right/Lateral-Left	10
880-319/21	9-10	Lateral-Right/Medial-Left	5
880-319/22	9-10	Lateral-Right/Medial-Left	10

* Tilastan = Ti6Al4V

LinkSymphoKnee Femoral Augments – L-Shaped, Micro-Sizes

cemented



REF MAT Tilastan*	Size	Side	Height mm
880-320/12	0	Medial-Right/Lateral-Left	10
880-320/22	0	Lateral-Right/Medial-Left	10
880-321/12	1-2	Medial-Right/Lateral-Left	10
880-321/22	1-2	Lateral-Right/Medial-Left	10

LinkSymphoKnee Femoral Augments – L-Shaped

cemented



REF MAT Tilastan*	Size	Side	Height mm
880-323/13	3-4	Medial-Right/Lateral-Left	15
880-323/23	3-4	Lateral-Right/Medial-Left	15
880-325/13	5-6	Medial-Right/Lateral-Left	15
880-325/23	5-6	Lateral-Right/Medial-Left	15
880-327/13	7-8	Medial-Right/Lateral-Left	15
880-327/23	7-8	Lateral-Right/Medial-Left	15

LinkSymphoKnee Femoral Augments – L-Shaped, Macro-Sizes

cemented



REF MAT Tilastan*	Size	Side	Height mm
880-329/13	9-10	Medial-Right/Lateral-Left	15
880-329/23	9-10	Lateral-Right/Medial-Left	15

* Tilastan = Ti6Al4V

LinkSymphoKnee Tibial Augments – Micro-Sizes

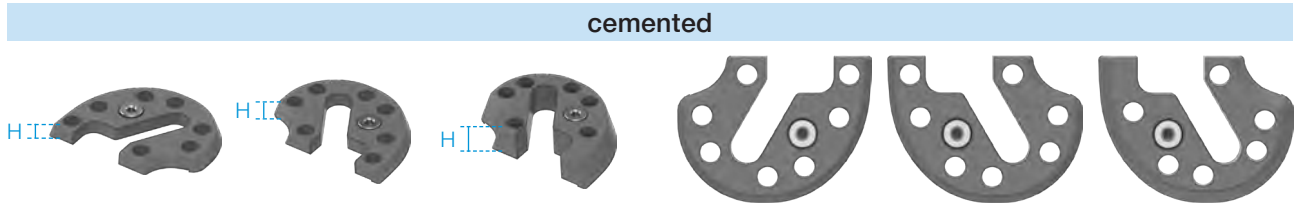

REF	Size	Side	Height mm
MAT Tilastan*			
880-331/11	1-2	Medial-Right/Lateral-Left	5
880-331/12	1-2	Medial-Right/Lateral-Left	10
880-331/13	1-2	Medial-Right/Lateral-Left	15
880-331/21	1-2	Lateral-Right/Medial-Left	5
880-331/22	1-2	Lateral-Right/Medial-Left	10
880-331/23	1-2	Lateral-Right/Medial-Left	15

LinkSymphoKnee Tibial Augments

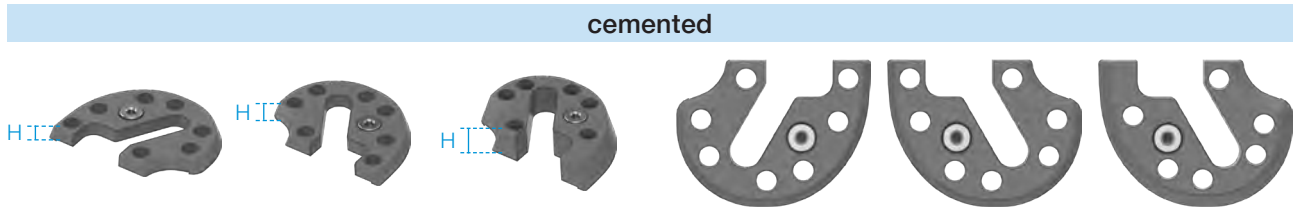

REF	Size	Side	Height mm
MAT Tilastan*			
880-333/11	3-4	Medial-Right/Lateral-Left	5
880-333/12	3-4	Medial-Right/Lateral-Left	10
880-333/13	3-4	Medial-Right/Lateral-Left	15
880-333/21	3-4	Lateral-Right/Medial-Left	5
880-333/22	3-4	Lateral-Right/Medial-Left	10
880-333/23	3-4	Lateral-Right/Medial-Left	15
880-335/11	5-6	Medial-Right/Lateral-Left	5
880-335/12	5-6	Medial-Right/Lateral-Left	10
880-335/13	5-6	Medial-Right/Lateral-Left	15
880-335/21	5-6	Lateral-Right/Medial-Left	5
880-335/22	5-6	Lateral-Right/Medial-Left	10
880-335/23	5-6	Lateral-Right/Medial-Left	15
880-337/11	7-8	Medial-Right/Lateral-Left	5
880-337/12	7-8	Medial-Right/Lateral-Left	10
880-337/13	7-8	Medial-Right/Lateral-Left	15
880-337/21	7-8	Lateral-Right/Medial-Left	5
880-337/22	7-8	Lateral-Right/Medial-Left	10
880-337/23	7-8	Lateral-Right/Medial-Left	15

LinkSymphoKnee Tibial Augments – Macro-Sizes

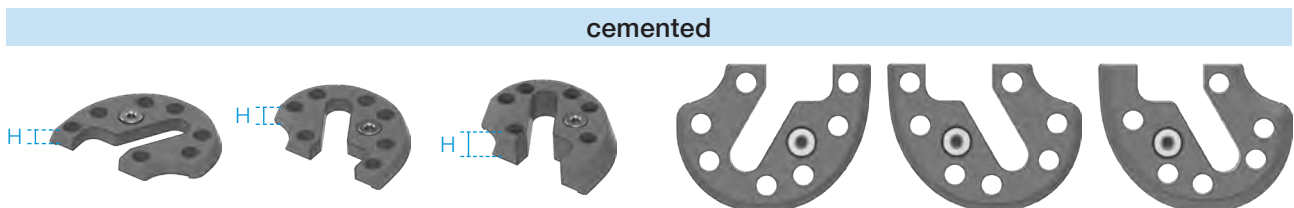

REF	Size	Side	Height mm
MAT Tilastan*			
880-339/11	9-10	Medial-Right/Lateral-Left	5
880-339/12	9-10	Medial-Right/Lateral-Left	10
880-339/13	9-10	Medial-Right/Lateral-Left	15
880-339/21	9-10	Lateral-Right/Medial-Left	5
880-339/22	9-10	Lateral-Right/Medial-Left	10
880-339/23	9-10	Lateral-Right/Medial-Left	15

* Tilastan = Ti6Al4V

LinkSymphoKnee Patella Components – 3-peg

cemented

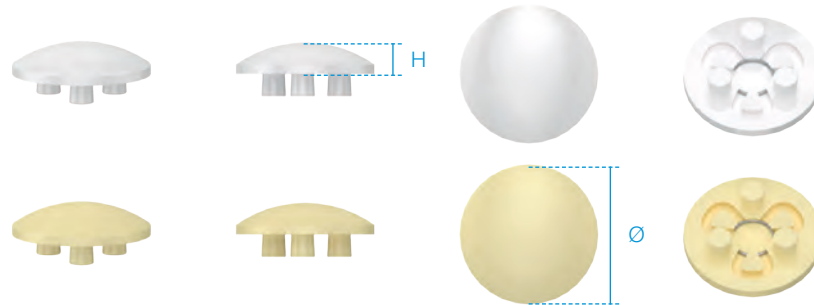

REF MAT UHMWPE	REF MAT E-Dur*	Ø mm	Height (H) mm
880-501/25	880-511/25	25	6
880-501/28	880-511/28	28	6
880-501/31	880-511/31	31	7
880-501/34	880-511/34	34	8
880-501/37	880-511/37	37	9
880-501/40	880-511/40	40	10

* E-Dur = Highly crosslinked UHMWPE (X-Linked PE) with Vit-E

LinkSymphoKnee Instrument Sets: Overview

REF	CCK Instruments	CCK Basic Kit	CCK Micro-Sizes	CCK Macro-Sizes	CCK Wide-Sizes
881-001/00	General Instruments – Blue feet	X	X	X	X
881-005/10	CCK Articulating Surface Trials – Yellow feet	X	X	X	X
881-006/10	CCK Instruments & Trials – Yellow feet	X	X	X	X
881-007/10	CCK Preparation Instruments – Yellow feet	X	X	X	X
881-006/00	CCK Instruments & Trials Micro-Sizes – Yellow feet		X		
881-007/00	CCK Preparation Instruments Micro-Sizes – Yellow feet		X		
881-006/20	CCK Instruments & Trials Macro-Sizes – Yellow feet			X	
881-007/20	CCK Preparation Instruments Macro-Sizes – Yellow feet			X	
881-006/30	CCK Instruments & Trials Wide-Sizes – Yellow feet				X
	Additional Instrument Sets:				
881-008/00	Press-Fit Stem Reamers – Yellow feet				
881-008/10	Press-Fit Stem Trials – Yellow feet				
151-07/00	Ball Reamers & Trial Centralizers – Green feet				
151-08/00	Conical Cemented Stem Trials – Yellow feet				
151-09/00	Conical Cementless Stem Instruments & Trials, 128 mm – Yellow feet				
151-10/00	Conical Cementless Stem Instruments & Trials, 158 mm – Yellow feet				
151-11/00	Conical Cementless Stem Instruments & Trials, 188 mm – Yellow feet				
881-009/00	Patella Instruments & Trials – Blue feet				

LinkSymphoKnee Instruments upon request

REF	Instruments upon request
445-126/65	Thread Pins, L = 65 mm, Ø 3.0 mm
445-126/95	Thread Pins, L = 95 mm, Ø 3.0 mm
445-127/35	Headed Thread Pins, L = 35 mm, Ø 3.0 mm
445-127/65	Headed Thread Pins, L = 65 mm, Ø 3.0 mm

881-001/00 General Instruments – Blue feet

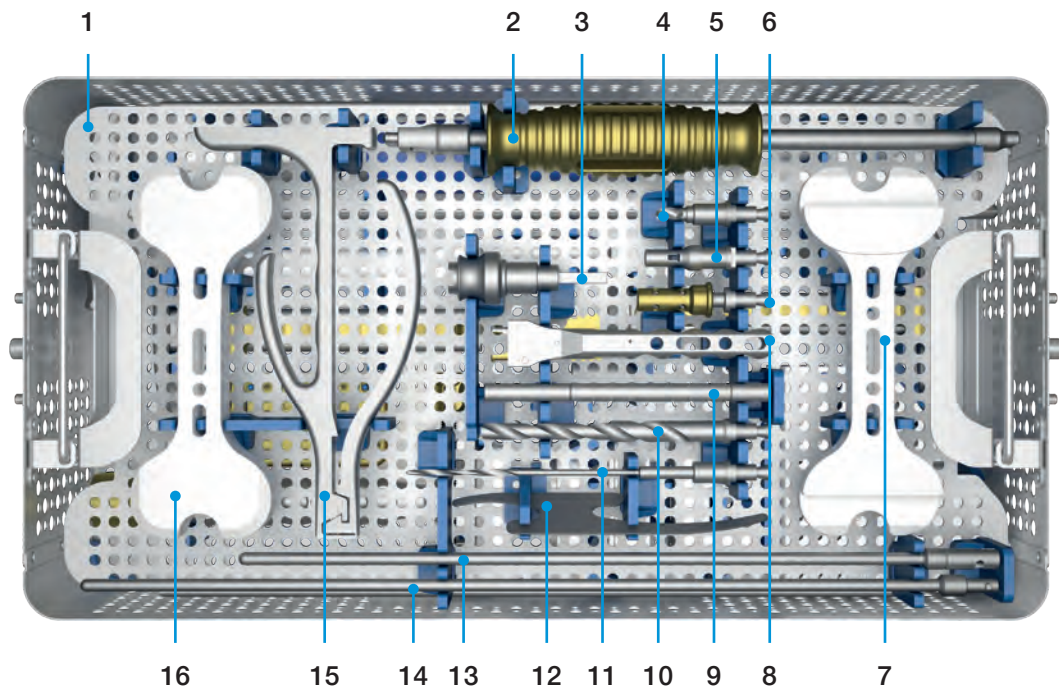

			Qty.
1	881-010/00	LinkSymphoKnee General Instruments Tray – Upper Tray	1
2	445-206/00	Slaphammer	1
3	16-3283/01	Adapter, Hudson/Jakobs Fitting (E)	1
4	881-012/00	Universal Drill, Hudson Fitting (B)	1
5	445-122/00	Power Driver, Hudson Fitting	1
6	445-122/10	Power Driver with snap lock, Hudson Fitting	1
7	881-011/02	Spacer 4-in-1 Cut, Flexion, H = 10-12 mm	1
8	445-112/00	Handle, Quick Connect	1
9	445-121/00	Pin Inserter, universal	1
10	319-505/00B	Step Drill, with Hudson Fitting (B)	1
11	15-2040/02B	Twist Drill 3 mm, Hudson Fitting	1
12	317-802/53	Cutting Template	1
13	445-113/10	Alignment Rod, extramedullary, short	1
14	445-113/20	Alignment Rod, extramedullary, long	1
15	445-120/00	Pin Inserter/Extractor, universal	1
16	881-010/02	Spacer Flexion/Extension, H = 10-12 mm	1

881-001/00 General Instruments – Blue feet

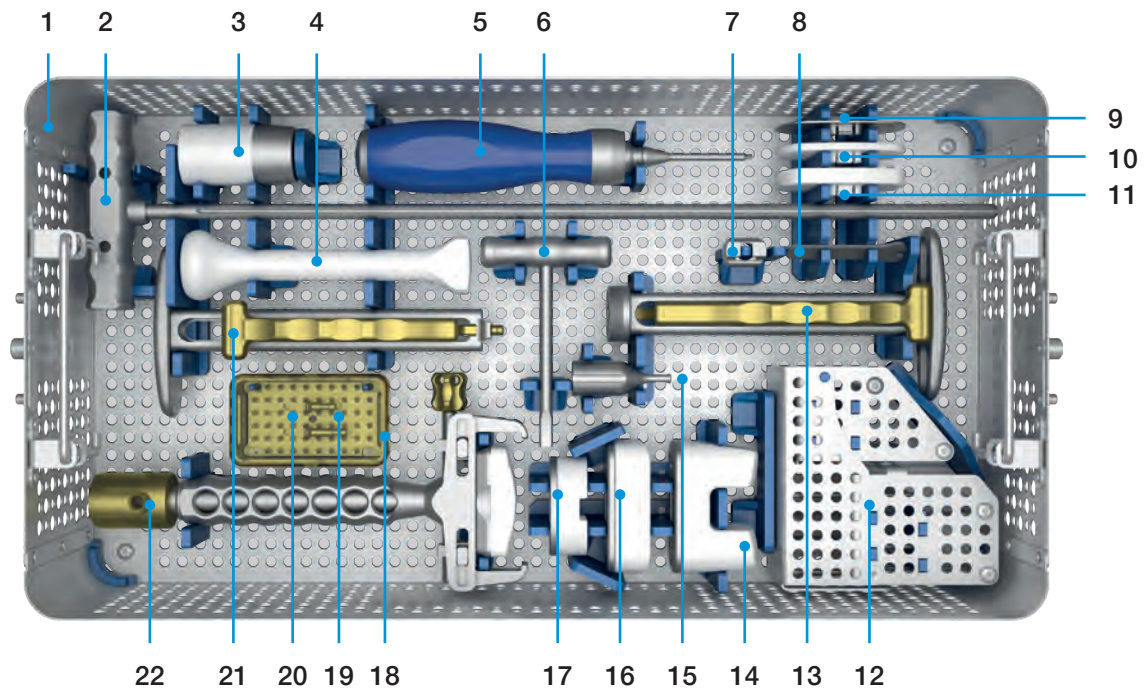

			Qty.
1	881-010/00	LinkSymphoKnee General Instruments Tray – Lower Tray	1
2	445-101/00	Intramedullary Rod, Ø 8.0 mm	1
3	881-040/99	Tibial/Femoral Coupling Base Tip	1
4	881-040/01	Articulating Surface Impactor	1
5	15-2545	Torque Wrench, hex 2.5 mm	1
6	881-019/00	Articulating Surface Extractor	1
7	881-043/00	Tibial Extractor Tip	1
8	151-131/00	Screwdriver for Cone Adapter	1
9	881-019/01	Shim, Spacer, H = 1 mm	1
10	881-019/04	Shim, Spacer, H = 4 mm	1
11	881-019/08	Shim, Spacer, H = 8 mm	1
12	445-123/00	Pin Box	1
	445-124/65	Drill Pin, L = 65 mm, Ø 3.0 mm	4
	445-124/95	Drill Pin, L = 95 mm, Ø 3.0 mm	4
	445-125/35	Drill Pin, Headed, L = 35 mm, Ø 3.0 mm	4
	445-125/65	Drill Pin, Headed, L = 65 mm, Ø 3.0 mm	4
	445-128/25	Bone Nail, L = 25 mm, Ø 3.0 mm	4
	445-128/35	Bone Nail, L = 35 mm, Ø 3.0 mm	4
	445-128/65	Bone Nail, L = 65 mm, Ø 3.0 mm	4
13	881-042/00	Tibial Inserter	1
14	881-042/90	Tibial Impactor Tip, All Poly	1
15	151-132/00	Modular Extractor Tip	1
16	881-041/99	Femoral Impactor Tip	1
17	881-042/99	Tibial Impactor Tip	1
18	881-053/00	Locking Screw Tibial Plateau, long	1
19	881-052/00	Locking Screw Tibial Plateau, short	1
20	319-601/30	Sterilizing Box, small	1
21	445-207/00	Handle, Impactor/Extractor	1
22	881-041/00	Femoral Inserter/Extractor	1

881-005/10 CCK Articulating Surface Trials – Yellow feet

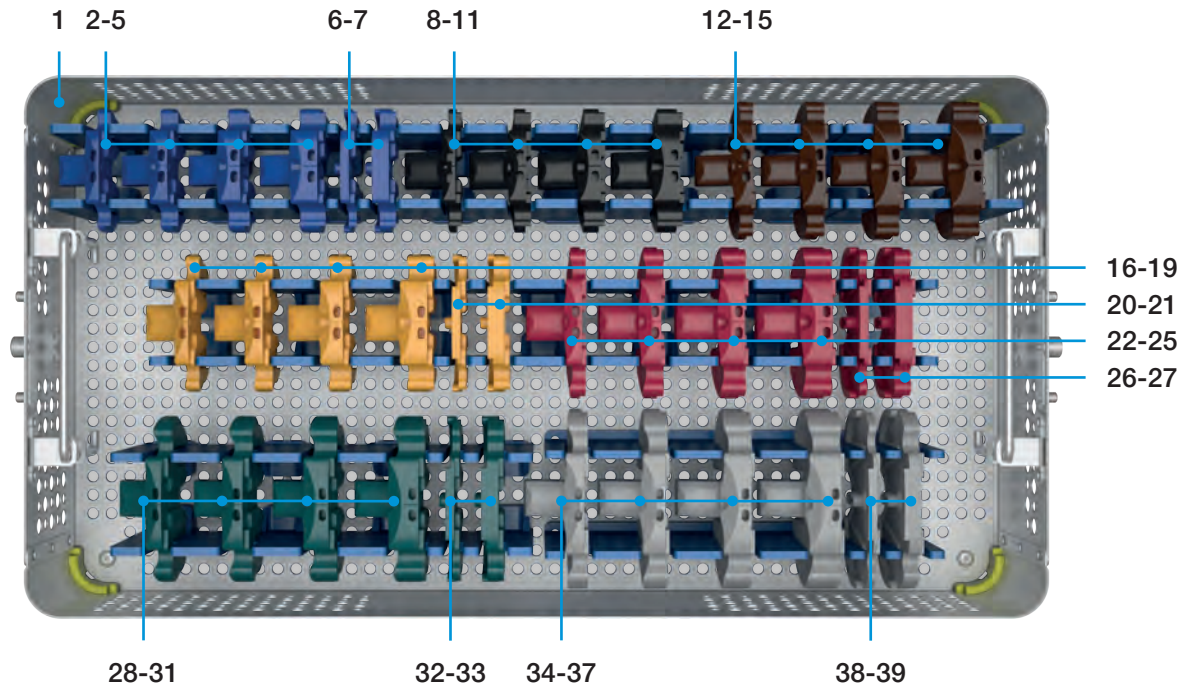

			Qty.
1	881-050/10	LinkSymphoKnee CCK Articulating Surface Trials Tray	1
2	881-251/10	Trial Plateau, CCK, Size 1-2, H = 10 mm	1
3	881-251/12	Trial Plateau, CCK, Size 1-2, H = 12 mm	1
4	881-251/14	Trial Plateau, CCK, Size 1-2, H = 14 mm	1
5	881-251/16	Trial Plateau, CCK, Size 1-2, H = 16 mm	1
6	881-220/41	Shim, Trial Plateau, H = +4 mm, Size 1-2	1
7	881-250/81	Shim, Trial Plateau, CCK, H = +8 mm, Size 1-2	1
8	881-252/10	Trial Plateau, CCK, Size 1-2up, H = 10 mm	1
9	881-252/12	Trial Plateau, CCK, Size 1-2up, H = 12 mm	1
10	881-252/14	Trial Plateau, CCK, Size 1-2up, H = 14 mm	1
11	881-252/16	Trial Plateau, CCK, Size 1-2up, H = 16 mm	1
12	881-254/10	Trial Plateau, CCK, Size 3-4down, H = 10 mm	1
13	881-254/12	Trial Plateau, CCK, Size 3-4down, H = 12 mm	1
14	881-254/14	Trial Plateau, CCK, Size 3-4down, H = 14 mm	1
15	881-254/16	Trial Plateau, CCK, Size 3-4down, H = 16 mm	1
16	881-253/10	Trial Plateau, CCK, Size 3-4, H = 10 mm	1
17	881-253/12	Trial Plateau, CCK, Size 3-4, H = 12 mm	1
18	881-253/14	Trial Plateau, CCK, Size 3-4, H = 14 mm	1
19	881-253/16	Trial Plateau, CCK, Size 3-4, H = 16 mm	1
20	881-220/43	Shim, Trial Plateau, H = +4 mm, Size 3-4	1
21	881-250/83	Shim, Trial Plateau, CCK, H = +8 mm, Size 3-4	1
22	881-255/10	Trial Plateau, CCK, Size 5-6, H = 10 mm	1
23	881-255/12	Trial Plateau, CCK, Size 5-6, H = 12 mm	1
24	881-255/14	Trial Plateau, CCK, Size 5-6, H = 14 mm	1
25	881-255/16	Trial Plateau, CCK, Size 5-6, H = 16 mm	1
26	881-220/45	Shim, Trial Plateau, H = +4 mm, Size 5-6	1
27	881-250/85	Shim, Trial Plateau, CCK, H = +8 mm, Size 5-6	1
28	881-257/10	Trial Plateau, CCK, Size 7-8, H = 10 mm	1
29	881-257/12	Trial Plateau, CCK, Size 7-8, H = 12 mm	1
30	881-257/14	Trial Plateau, CCK, Size 7-8, H = 14 mm	1
31	881-257/16	Trial Plateau, CCK, Size 7-8, H = 16 mm	1
32	881-220/47	Shim, Trial Plateau, H = +4 mm, Size 7-8	1
33	881-250/87	Shim, Trial Plateau, CCK, H = +8 mm, Size 7-8	1
34	881-259/10	Trial Plateau, CCK, Size 9-10, H = 10 mm	1
35	881-259/12	Trial Plateau, CCK, Size 9-10, H = 12 mm	1
36	881-259/14	Trial Plateau, CCK, Size 9-10, H = 14 mm	1
37	881-259/16	Trial Plateau, CCK, Size 9-10, H = 16 mm	1
38	881-220/49	Shim, Trial Plateau, H = +4 mm, Size 9-10	1
39	881-250/89	Shim, Trial Plateau, CCK, H = +8 mm, Size 9-10	1

881-006/10 CCK Instruments & Trials – Yellow feet

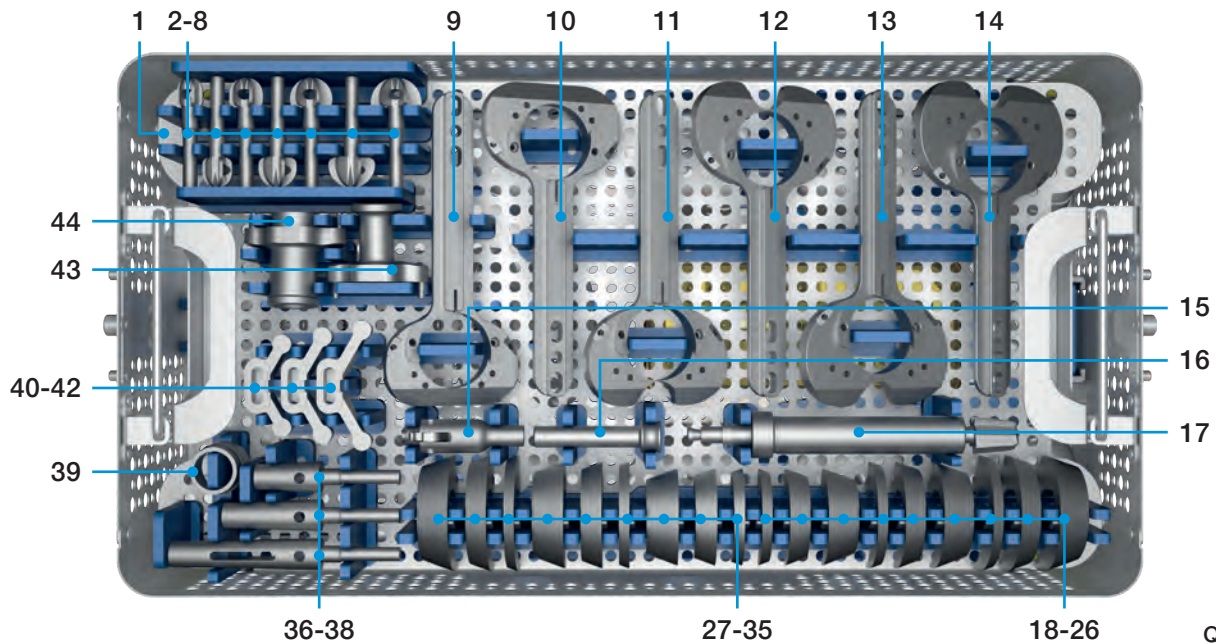

				Qty.
1	881-060/10	LinkSymphoKnee CCK Instruments & Trials Tray – Upper Tray		1
2	151-050/10	50 mm Trial Stem Conical Cemented with Ø 12 mm Centralizer		1
3	151-050/14	50 mm Trial Stem Conical Cemented with Ø 14 mm Centralizer		1
4	151-050/16	50 mm Trial Stem Conical Cemented with Ø 16 mm Centralizer		1
5	151-050/18	50 mm Trial Stem Conical Cemented with Ø 18 mm Centralizer		1
6	151-050/20	50 mm Trial Stem Conical Cemented with Ø 20 mm Centralizer		1
7	151-050/22	50 mm Trial Stem Conical Cemented with Ø 22 mm Centralizer		1
8	151-050/24	50 mm Trial Stem Conical Cemented with Ø 24 mm Centralizer		1
9	881-285/30	Tibial Preparation Plate, CCK, Size 3		1
10	881-285/40	Tibial Preparation Plate, CCK, Size 4		1
11	881-285/50	Tibial Preparation Plate, CCK, Size 5		1
12	881-285/60	Tibial Preparation Plate, CCK, Size 6		1
13	881-285/70	Tibial Preparation Plate, CCK, Size 7		1
14	881-285/80	Tibial Preparation Plate, CCK, Size 8		1
15	151-501/00	Neutral Stem Adapter		1
16	881-070/08	Sleeve, Assignment for Intramedullary Rod, Ø 8 mm		1
17	881-067/17	Tapered Reamer, CCK		1
18	881-333/11	Tibial Trial Augment, Medial-Right/Lateral-Left, Size 3-4, H = 5 mm		1
19	881-333/12	Tibial Trial Augment, Medial-Right/Lateral-Left, Size 3-4, H = 10 mm		1
20	881-333/13	Tibial Trial Augment, Medial-Right/Lateral-Left, Size 3-4, H = 15 mm		1
21	881-335/11	Tibial Trial Augment, Medial-Right/Lateral-Left, Size 5-6, H = 5 mm		1
22	881-335/12	Tibial Trial Augment, Medial-Right/Lateral-Left, Size 5-6, H = 10 mm		1
23	881-335/13	Tibial Trial Augment, Medial-Right/Lateral-Left, Size 5-6, H = 15 mm		1
24	881-337/11	Tibial Trial Augment, Medial-Right/Lateral-Left, Size 7-8, H = 5 mm		1
25	881-337/12	Tibial Trial Augment, Medial-Right/Lateral-Left, Size 7-8, H = 10 mm		1
26	881-337/13	Tibial Trial Augment, Medial-Right/Lateral-Left, Size 7-8, H = 15 mm		1
27	881-333/21	Tibial Trial Augment, Lateral-Right/Medial-Left, Size 3-4, H = 5 mm		1
28	881-333/22	Tibial Trial Augment, Lateral-Right/Medial-Left, Size 3-4, H = 10 mm		1
29	881-333/23	Tibial Trial Augment, Lateral-Right/Medial-Left, Size 3-4, H = 15 mm		1
30	881-335/21	Tibial Trial Augment, Lateral-Right/Medial-Left, Size 5-6, H = 5 mm		1
31	881-335/22	Tibial Trial Augment, Lateral-Right/Medial-Left, Size 5-6, H = 10 mm		1
32	881-335/23	Tibial Trial Augment, Lateral-Right/Medial-Left, Size 5-6, H = 15 mm		1
33	881-337/21	Tibial Trial Augment, Lateral-Right/Medial-Left, Size 7-8, H = 5 mm		1
34	881-337/22	Tibial Trial Augment, Lateral-Right/Medial-Left, Size 7-8, H = 10 mm		1
35	881-337/23	Tibial Trial Augment, Lateral-Right/Medial-Left, Size 7-8, H = 15 mm		1
36	151-080/15	80 mm Trial Stem Conical Cemented, Ø 15 mm		1
37	151-095/15	95 mm Trial Stem Conical Cemented, Ø 15 mm		1
38	151-120/15	120 mm Trial Stem Conical Cemented, Ø 15 mm		1
39	881-065/09	Reamer Stopper, Offset		1
40	881-275/34	Tibial Keel Punch, CCK, Size 3-4		1
41	881-275/56	Tibial Keel Punch, CCK, Size 5-6		1
42	881-275/78	Tibial Keel Punch, CCK, Size 7-8		1
43	881-055/00	Neutral Alignment Guide, CCK, 0 mm offset		1
44	881-065/00	Tibial Reamer Guide, CCK		1

881-006/10 CCK Instruments & Trials – Yellow feet

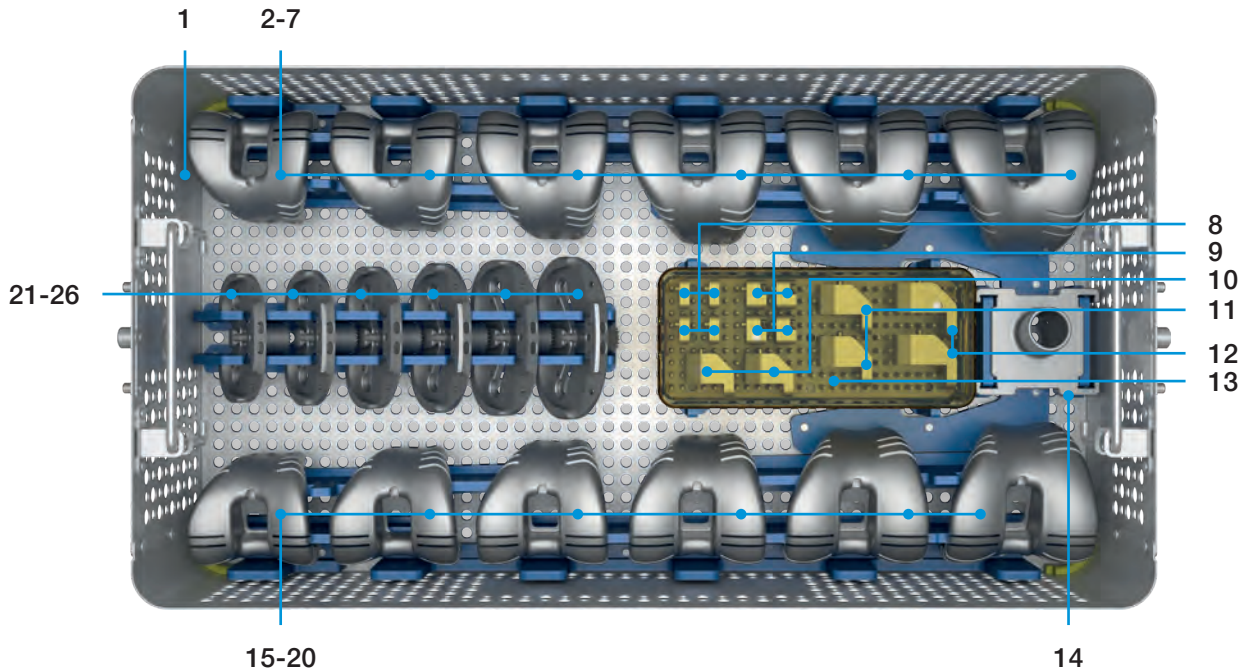

			Qty.
1	881-060/10	LinkSymphoKnee CCK Instruments & Trials Tray – Lower Tray	1
2	881-150/30	Femoral Trial, CCK, right, Size 3	1
3	881-150/40	Femoral Trial, CCK, right, Size 4	1
4	881-150/50	Femoral Trial, CCK, right, Size 5	1
5	881-150/60	Femoral Trial, CCK, right, Size 6	1
6	881-150/70	Femoral Trial, CCK, right, Size 7	1
7	881-150/80	Femoral Trial, CCK, right, Size 8	1
8	881-302/91	Femoral Trial Augment, H = 5 mm	4
9	881-302/92	Femoral Trial Augment, H = 10 mm	4
10	881-323/93	Femoral Trial Augment, L-Shaped, Size 3-4, H = 15 mm	2
11	881-325/93	Femoral Trial Augment, L-Shaped, Size 5-6, H = 15 mm	2
12	881-327/93	Femoral Trial Augment, L-Shaped, Size 7-8, H = 15 mm	2
13	319-603/30	Sterilizing Box, medium high	1
14	881-116/00	Reamer Guide, Femoral Box, CCK	1
15	881-151/30	Femoral Trial, CCK, left, Size 3	1
16	881-151/40	Femoral Trial, CCK, left, Size 4	1
17	881-151/50	Femoral Trial, CCK, left, Size 5	1
18	881-151/60	Femoral Trial, CCK, left, Size 6	1
19	881-151/70	Femoral Trial, CCK, left, Size 7	1
20	881-151/80	Femoral Trial, CCK, left, Size 8	1
21	881-258/30	Tibial Trial Component, CCK, Size 3	1
22	881-258/40	Tibial Trial Component, CCK, Size 4	1
23	881-258/50	Tibial Trial Component, CCK, Size 5	1
24	881-258/60	Tibial Trial Component, CCK, Size 6	1
25	881-258/70	Tibial Trial Component, CCK, Size 7	1
26	881-258/80	Tibial Trial Component, CCK, Size 8	1

881-007/10 CCK Preparation Instruments – Yellow feet

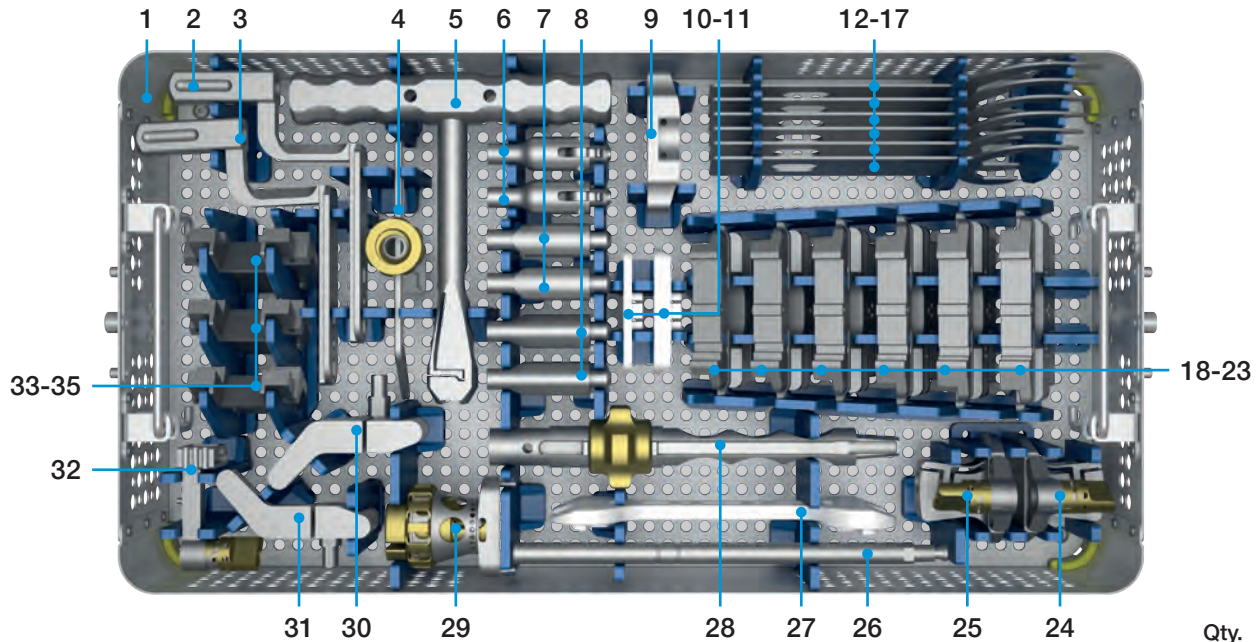

			Qty.
1	881-070/10	LinkSymphoKnee CCK Preparation Instruments Tray	1
2	151-201/00	Tibial Guide, Intramedullary, 0°	1
3	881-059/00	Tibial Guide, Intramedullary, 3°, CCK	1
4	445-111/00	Stylus, adjustable	1
5	15-6053/00	T-Handle	1
6	151-501/00	Neutral Stem Adapter	2
7	151-803/03	3 mm Offset Adapter	2
8	151-806/06	6 mm Offset Adapter	2
9	881-159/00	Femoral Cutting Block, CCK, Distal Cut	1
10	881-013/16	Shim, Spacer 4-in-1 Cut CCK, Flexion, H = 4 mm	1
11	881-013/20	Shim, Spacer 4-in-1 Cut CCK, Flexion, H = 8 mm	1
12	881-105/30	Femoral Sizer, Template, Size 3, CCK	1
13	881-105/40	Femoral Sizer, Template, Size 4, CCK	1
14	881-105/50	Femoral Sizer, Template, Size 5, CCK	1
15	881-105/60	Femoral Sizer, Template, Size 6, CCK	1
16	881-105/70	Femoral Sizer, Template, Size 7, CCK	1
17	881-105/80	Femoral Sizer, Template, Size 8, CCK	1
18	881-115/30	Femoral Cutting Block, CCK, 4-in-1 Cut, Size 3	1
19	881-115/40	Femoral Cutting Block, CCK, 4-in-1 Cut, Size 4	1
20	881-115/50	Femoral Cutting Block, CCK, 4-in-1 Cut, Size 5	1
21	881-115/60	Femoral Cutting Block, CCK, 4-in-1 Cut, Size 6	1
22	881-115/70	Femoral Cutting Block, CCK, 4-in-1 Cut, Size 7	1
23	881-115/80	Femoral Cutting Block, CCK, 4-in-1 Cut, Size 8	1
24	881-050/06	Femoral Alignment Guide, CCK, Varus/Valgus Adjustment 6°, right	1
25	881-051/06	Femoral Alignment Guide, CCK, Varus/Valgus Adjustment 6°, left	1
26	881-056/00	Trial Stem Rod, Intramedullary	1
27	881-013/00	Spacer 4-in-1 Cut, CCK, Flexion, H = 10-12 mm	1
28	151-144/00	Extractor for Modular Stems/Offset Stems	1
29	881-099/00	Offset Selector, CCK	1
30	151-204/00	Tibial Cutting Block, right	1
31	151-203/00	Tibial Cutting Block, left	1
32	151-202/00	Tibial Guide Connector	1
33	881-114/34	Femoral Box Guide, CCK, Size 3-4	1
34	881-114/56	Femoral Box Guide, CCK, Size 5-6	1
35	881-114/78	Femoral Box Guide, CCK, Size 7-8	1

881-006/00 CCK Instruments & Trials Micro-Sizes – Yellow feet

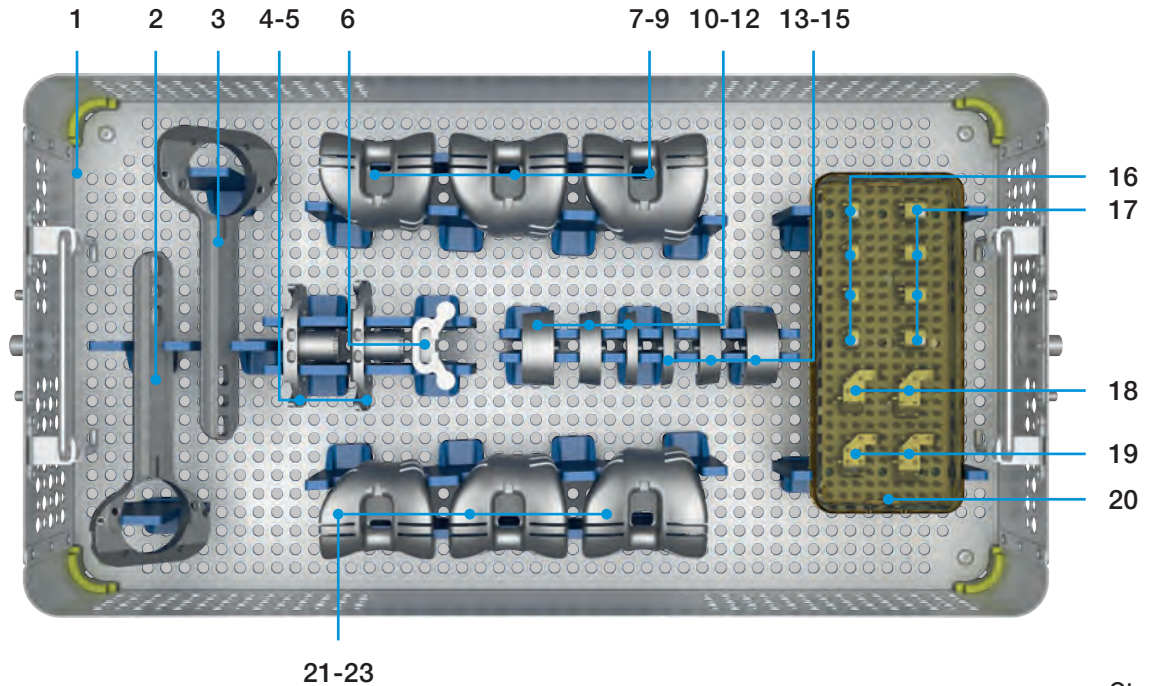

			Qty.
1	881-060/00	LinkSymphoKnee CCK Instruments & Trials Micro-Sizes Tray	1
2	881-285/10	Tibial Preparation Plate, CCK, Size 1	1
3	881-285/20	Tibial Preparation Plate, CCK, Size 2	1
4	881-258/10	Tibial Trial Component, CCK, Size 1	1
5	881-258/20	Tibial Trial Component, CCK, Size 2	1
6	881-275/12	Tibial Keel Punch, CCK, Size 1-2	1
7	881-150/00	Femoral Trial, CCK, right, Size 0	1
8	881-150/10	Femoral Trial, CCK, right, Size 1	1
9	881-150/20	Femoral Trial, CCK, right, Size 2	1
10	881-331/11	Tibial Trial Augment, Medial-Right/Lateral-Left, Size 1-2, H = 5 mm	1
11	881-331/12	Tibial Trial Augment, Medial-Right/Lateral-Left, Size 1-2, H = 10 mm	1
12	881-331/13	Tibial Trial Augment, Medial-Right/Lateral-Left, Size 1-2, H = 15 mm	1
13	881-331/21	Tibial Trial Augment, Lateral-Right/Medial-Left, Size 1-2, H = 5 mm	1
14	881-331/22	Tibial Trial Augment, Lateral-Right/Lateral-Left, Size 1-2, H = 10 mm	1
15	881-331/23	Tibial Trial Augment, Lateral-Right/Lateral-Left, Size 1-2, H = 15 mm	1
16	881-301/91	Femoral Trial Augment, Micro-Sizes, H = 5 mm	4
17	881-301/92	Femoral Trial Augment, Micro-Sizes, H = 10 mm	4
18	881-320/92	Femoral Trial Augment, L-Shaped, Size 0, H = 10 mm	2
19	881-321/92	Femoral Trial Augment, L-Shaped, Size 1-2, H = 10 mm	2
20	319-603/30	Sterilizing Box, medium high	1
21	881-151/00	Femoral Trial, CCK, left, Size 0	1
22	881-151/10	Femoral Trial, CCK, left, Size 1	1
23	881-151/20	Femoral Trial, CCK, left, Size 2	1

881-007/00 CCK Preparation Instruments Micro-Sizes – Yellow feet

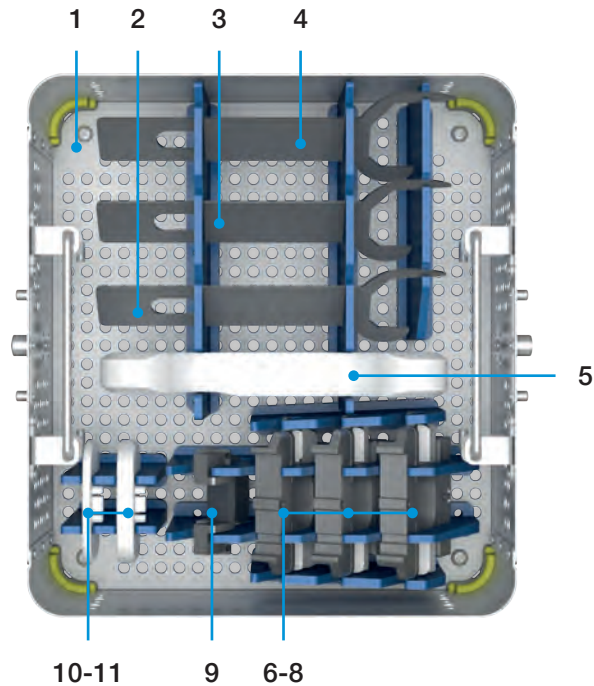

			Qty.
1	881-070/00	LinkSymphoKnee CCK Preparation Instruments Micro-Sizes Tray	1
2	881-105/00	Femoral Sizer, Template, Size 0, CCK	1
3	881-105/10	Femoral Sizer, Template, Size 1, CCK	1
4	881-105/20	Femoral Sizer, Template, Size 2, CCK	1
5	881-010/01	Spacer, Micro-Sizes, Flexion/ Extension, H = 10-12 mm	1
6	881-115/00	Femoral Cutting Block, CCK, 4-in-1 Cut, Size 0	1
7	881-115/10	Femoral Cutting Block, CCK, 4-in-1 Cut, Size 1	1
8	881-115/20	Femoral Cutting Block, CCK, 4-in-1 Cut, Size 2	1
9	881-114/02	Femoral Box Guide, CCK, Size 0-1-2	1
10	881-019/94	Shim, Spacer, H = 4 mm, Micro-Sizes	1
11	881-019/98	Shim, Spacer, H = 8 mm, Micro-Sizes	1

881-006/20 CCK Instruments & Trials Macro-Sizes – Yellow feet

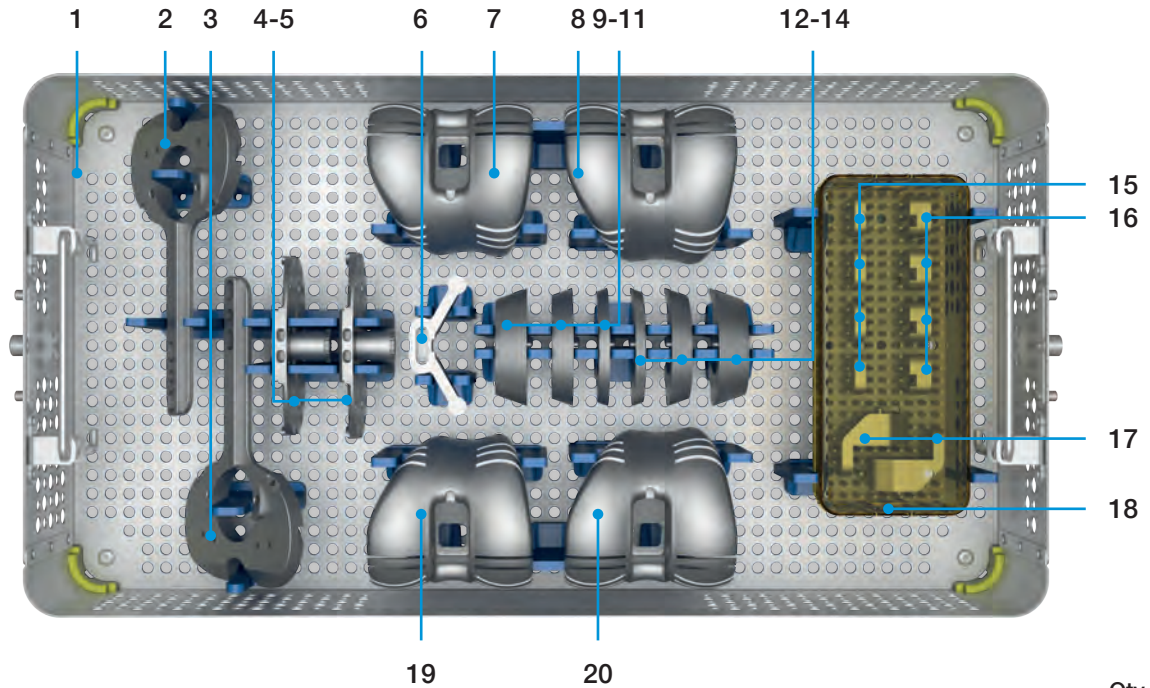

			Qty.
1	881-060/20	LinkSymphoKnee CCK Instruments & Trials Macro-Sizes Tray	1
2	881-285/90	Tibial Preparation Plate, CCK, Size 9	1
3	881-285/X0	Tibial Preparation Plate, CCK, Size 10	1
4	881-258/90	Tibial Trial Component, CCK, Size 9	1
5	881-258/X0	Tibial Trial Component, CCK, Size 10	1
6	881-275/9X	Tibial Keel Punch, CCK, Size 9-10	1
7	881-150/90	Femoral Trial, CCK, right, Size 9	1
8	881-150/X0	Femoral Trial, CCK, right, Size 10	1
9	881-339/11	Tibial Trial Augment, Medial-Right/Lateral-Left, Size 9-10, H = 5 mm	1
10	881-339/12	Tibial Trial Augment, Medial-Right/Lateral-Left, Size 9-10, H = 10 mm	1
11	881-339/13	Tibial Trial Augment, Medial-Right/Lateral-Left, Size 9-10, H = 15 mm	1
12	881-339/21	Tibial Trial Augment, Lateral-Right/Medial-Left, Size 9-10, H = 5 mm	1
13	881-339/22	Tibial Trial Augment, Lateral-Right/Medial-Left, Size 9-10, H = 10 mm	1
14	881-339/23	Tibial Trial Augment, Lateral-Right/Medial-Left, Size 9-10, H = 15 mm	1
15	881-303/91	Femoral Trial Augment, Macro-Sizes, H = 5 mm	4
16	881-303/92	Femoral Trial Augment, Macro-Sizes, H = 10 mm	4
17	881-329/93	Femoral Trial Augment, L-Shaped, Size 9-10, H = 15 mm	2
18	319-603/30	Sterilizing Box, medium high	1
19	881-151/90	Femoral Trial, CCK, left, Size 9	1
20	881-151/X0	Femoral Trial, CCK, left, Size 10	1

881-007/20 CCK Preparation Instruments Macro-Sizes – Yellow feet

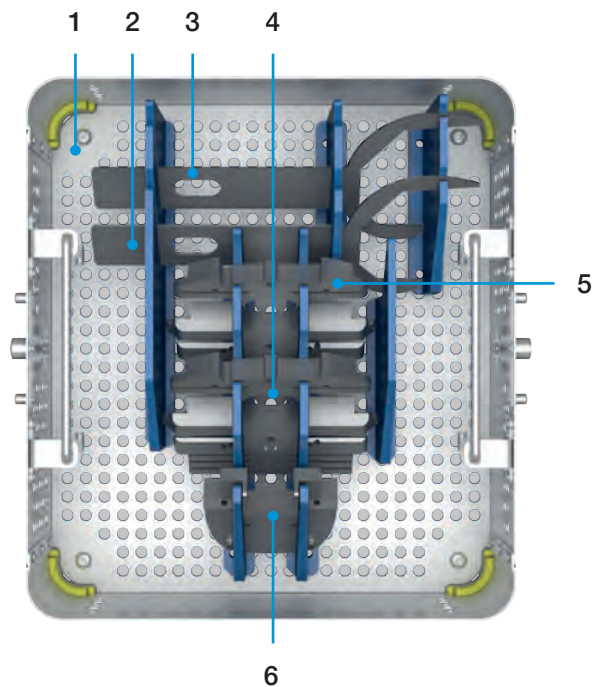

			Qty.
1	881-070/20	LinkSymphoKnee CCK Preparation Instruments Macro-Sizes Tray	1
2	881-105/90	Femoral Sizer, Template, Size 9, CCK	1
3	881-105/X0	Femoral Sizer, Template, Size 10, CCK	1
4	881-115/90	Femoral Cutting Block, CCK, 4-in-1 Cut, Size 9	1
5	881-115/X0	Femoral Cutting Block, CCK, 4-in-1 Cut, Size 10	1
6	881-114/9X	Femoral Box Guide, CCK, Size 9-10	1

881-006/30 CCK Instruments & Trials Wide-Sizes – Yellow feet

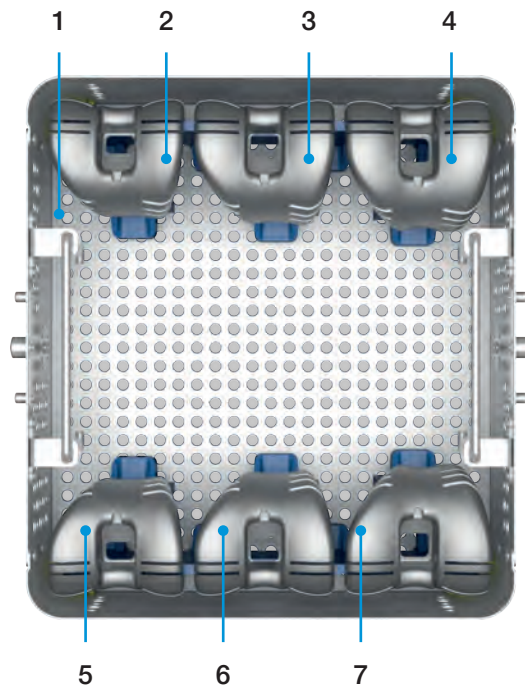

			Qty.
1	881-060/30	LinkSymphoKnee CCK Instruments & Trials Wide-Sizes Tray	1
2	881-150/35	Femoral Trial, CCK, right, Size 3+	1
3	881-150/45	Femoral Trial, CCK, right, Size 4+	1
4	881-150/55	Femoral Trial, CCK, right, Size 5+	1
5	881-151/35	Femoral Trial, CCK, left, Size 3+	1
6	881-151/45	Femoral Trial, CCK, left, Size 4+	1
7	881-151/55	Femoral Trial, CCK, left, Size 5+	1

881-008/00 Press-Fit Stem Reamers – Yellow feet

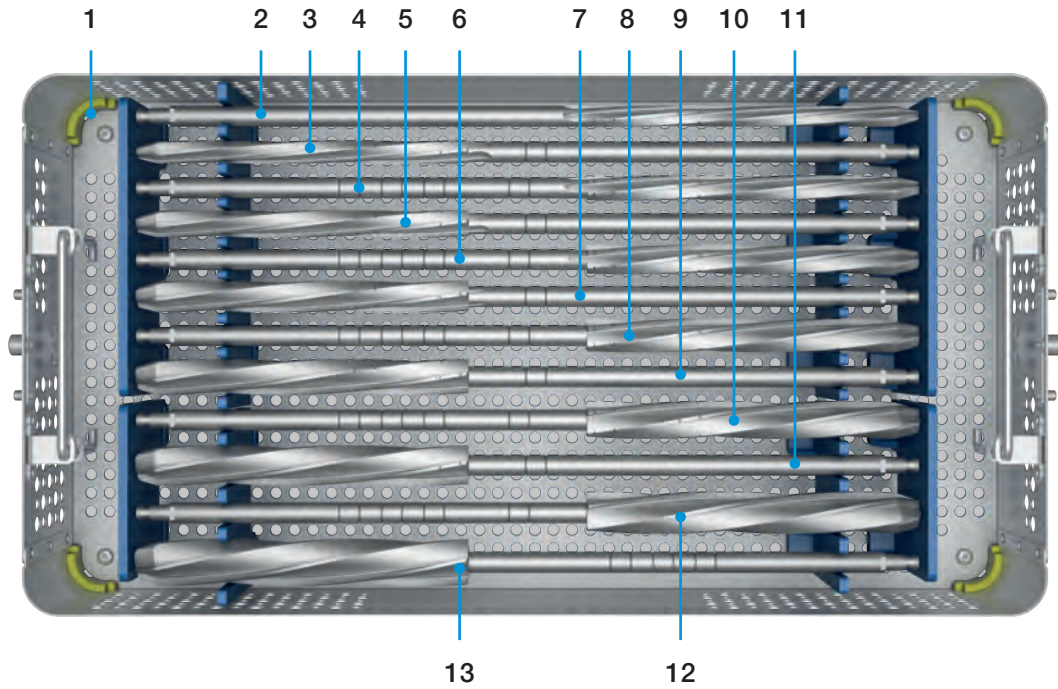

			Qty.
1	881-080/00	LinkSymphoKnee Press-Fit Stem Reamers	1
2	881-069/10	Reamer, cementless, cylindrical, Ø 10 mm	1
3	881-069/11	Reamer, cementless, cylindrical, Ø 11 mm	1
4	881-069/12	Reamer, cementless, cylindrical, Ø 12 mm	1
5	881-069/13	Reamer, cementless, cylindrical, Ø 13 mm	1
6	881-069/14	Reamer, cementless, cylindrical, Ø 14 mm	1
7	881-069/15	Reamer, cementless, cylindrical, Ø 15 mm	1
8	881-069/16	Reamer, cementless, cylindrical, Ø 16 mm	1
9	881-069/17	Reamer, cementless, cylindrical, Ø 17 mm	1
10	881-069/18	Reamer, cementless, cylindrical, Ø 18 mm	1
11	881-069/19	Reamer, cementless, cylindrical, Ø 19 mm	1
12	881-069/20	Reamer, cementless, cylindrical, Ø 20 mm	1
13	881-069/22	Reamer, cementless, cylindrical, Ø 22 mm	1

881-008/10 Press-Fit Stem Trials – Yellow feet

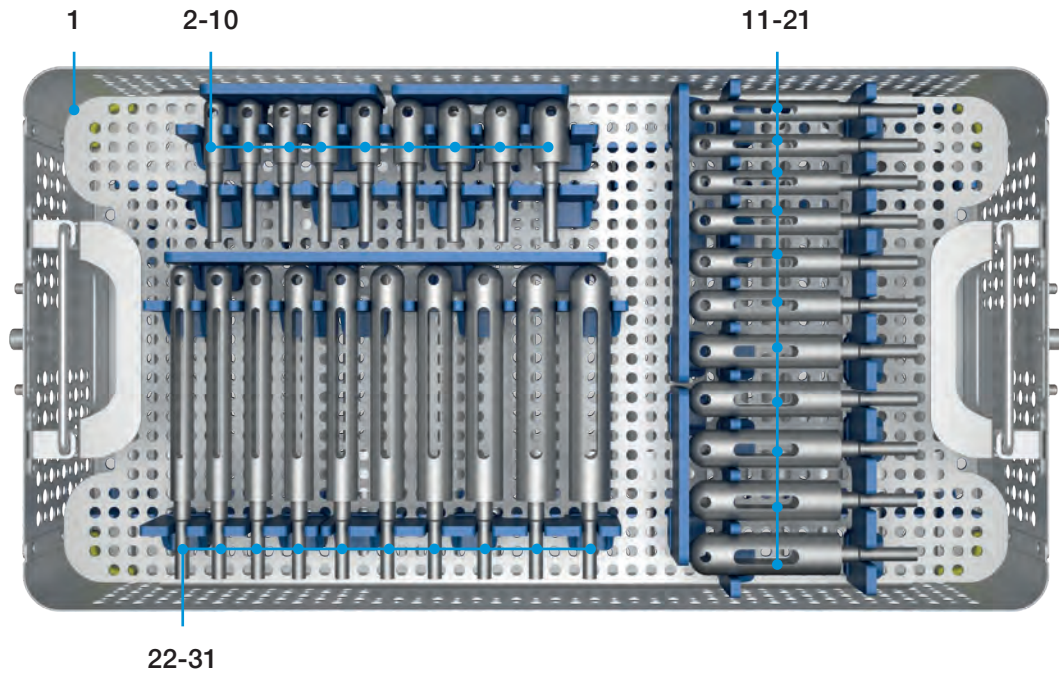

			Qty.
1	881-080/10	LinkSymphoKnee Press-Fit Stem Trials – Upper Tray	1
2	151-780/10	Trial Stem, cementless, cylindrical, Ø 10 mm, Stem.L 80 mm	1
3	151-780/11	Trial Stem, cementless, cylindrical, Ø 11 mm, Stem.L 80 mm	1
4	151-780/12	Trial Stem, cementless, cylindrical, Ø 12 mm, Stem.L 80 mm	1
5	151-780/13	Trial Stem, cementless, cylindrical, Ø 13 mm, Stem.L 80 mm	1
6	151-780/14	Trial Stem, cementless, cylindrical, Ø 14 mm, Stem.L 80 mm	1
7	151-780/15	Trial Stem, cementless, cylindrical, Ø 15 mm, Stem.L 80 mm	1
8	151-780/16	Trial Stem, cementless, cylindrical, Ø 16 mm, Stem.L 80 mm	1
9	151-780/17	Trial Stem, cementless, cylindrical, Ø 17 mm, Stem.L 80 mm	1
10	151-780/18	Trial Stem, cementless, cylindrical, Ø 18 mm, Stem.L 80 mm	1
11	151-712/10	Trial Stem, cementless, cylindrical, Ø 10 mm, Stem.L 120 mm	1
12	151-712/11	Trial Stem, cementless, cylindrical, Ø 11 mm, Stem.L 120 mm	1
13	151-712/12	Trial Stem, cementless, cylindrical, Ø 12 mm, Stem.L 120 mm	1
14	151-712/13	Trial Stem, cementless, cylindrical, Ø 13 mm, Stem.L 120 mm	1
15	151-712/14	Trial Stem, cementless, cylindrical, Ø 14 mm, Stem.L 120 mm	1
16	151-712/15	Trial Stem, cementless, cylindrical, Ø 15 mm, Stem.L 120 mm	1
17	151-712/16	Trial Stem, cementless, cylindrical, Ø 16 mm, Stem.L 120 mm	1
18	151-712/17	Trial Stem, cementless, cylindrical, Ø 17 mm, Stem.L 120 mm	1
19	151-712/18	Trial Stem, cementless, cylindrical, Ø 18 mm, Stem.L 120 mm	1
20	151-712/19	Trial Stem, cementless, cylindrical, Ø 19 mm, Stem.L 120 mm	1
21	151-712/20	Trial Stem, cementless, cylindrical, Ø 20 mm, Stem.L 120 mm	1
22	151-716/11	Trial Stem, cementless, cylindrical, Ø 11 mm, Stem.L 160 mm	1
23	151-716/12	Trial Stem, cementless, cylindrical, Ø 12 mm, Stem.L 160 mm	1
24	151-716/13	Trial Stem, cementless, cylindrical, Ø 13 mm, Stem.L 160 mm	1
25	151-716/14	Trial Stem, cementless, cylindrical, Ø 14 mm, Stem.L 160 mm	1
26	151-716/15	Trial Stem, cementless, cylindrical, Ø 15 mm, Stem.L 160 mm	1
27	151-716/16	Trial Stem, cementless, cylindrical, Ø 16 mm, Stem.L 160 mm	1
28	151-716/17	Trial Stem, cementless, cylindrical, Ø 17 mm, Stem.L 160 mm	1
29	151-716/18	Trial Stem, cementless, cylindrical, Ø 18 mm, Stem.L 160 mm	1
30	151-716/19	Trial Stem, cementless, cylindrical, Ø 19 mm, Stem.L 160 mm	1
31	151-716/20	Trial Stem, cementless, cylindrical, Ø 20 mm, Stem.L 160 mm	1

881-008/10 Press-Fit Stem Trials – Yellow feet

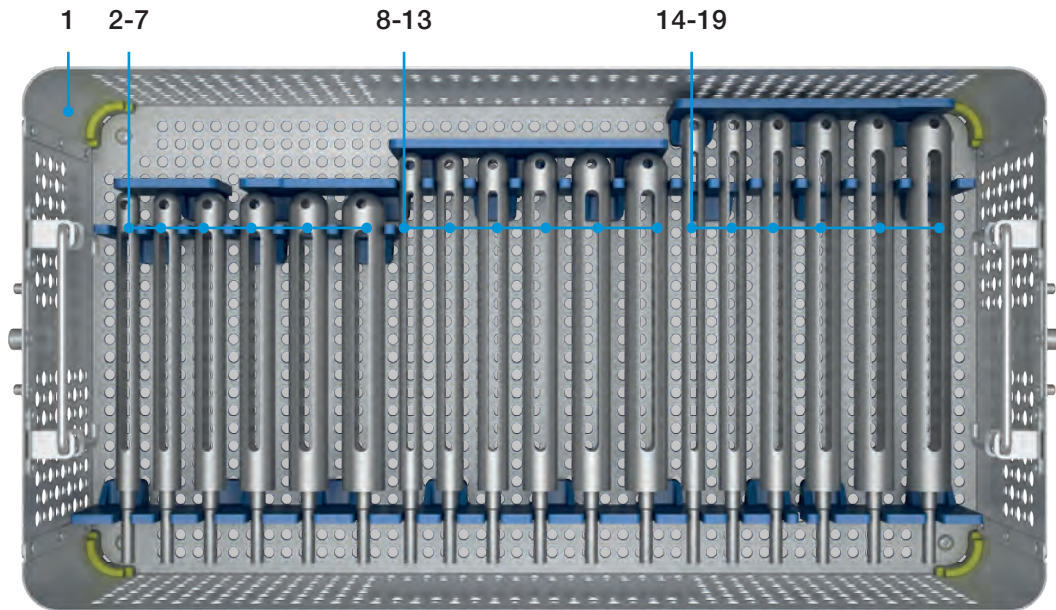

			Qty.
1	881-080/10	LinkSymphoKnee Press-Fit Stem Trials – Lower Tray	1
2	151-720/12	Trial Stem, cementless, cylindrical, Ø 12 mm, Stem.L 200 mm	1
3	151-720/14	Trial Stem, cementless, cylindrical, Ø 14 mm, Stem.L 200 mm	1
4	151-720/16	Trial Stem, cementless, cylindrical, Ø 16 mm, Stem.L 200 mm	1
5	151-720/18	Trial Stem, cementless, cylindrical, Ø 18 mm, Stem.L 200 mm	1
6	151-720/20	Trial Stem, cementless, cylindrical, Ø 20 mm, Stem.L 200 mm	1
7	151-720/22	Trial Stem, cementless, cylindrical, Ø 22 mm, Stem.L 200 mm	1
8	151-722/12	Trial Stem, cementless, cylindrical, Ø 12 mm, Stem.L 220 mm	1
9	151-722/14	Trial Stem, cementless, cylindrical, Ø 14 mm, Stem.L 220 mm	1
10	151-722/16	Trial Stem, cementless, cylindrical, Ø 16 mm, Stem.L 220 mm	1
11	151-722/18	Trial Stem, cementless, cylindrical, Ø 18 mm, Stem.L 220 mm	1
12	151-722/20	Trial Stem, cementless, cylindrical, Ø 20 mm, Stem.L 220 mm	1
13	151-722/22	Trial Stem, cementless, cylindrical, Ø 22 mm, Stem.L 220 mm	1
14	151-724/12	Trial Stem, cementless, cylindrical, Ø 12 mm, Stem.L 240 mm	1
15	151-724/14	Trial Stem, cementless, cylindrical, Ø 14 mm, Stem.L 240 mm	1
16	151-724/16	Trial Stem, cementless, cylindrical, Ø 16 mm, Stem.L 240 mm	1
17	151-724/18	Trial Stem, cementless, cylindrical, Ø 18 mm, Stem.L 240 mm	1
18	151-724/20	Trial Stem, cementless, cylindrical, Ø 20 mm, Stem.L 240 mm	1
19	151-724/22	Trial Stem, cementless, cylindrical, Ø 22 mm, Stem.L 240 mm	1

151-07/00 Ball Reamers & Trial Centralizers – Green feet

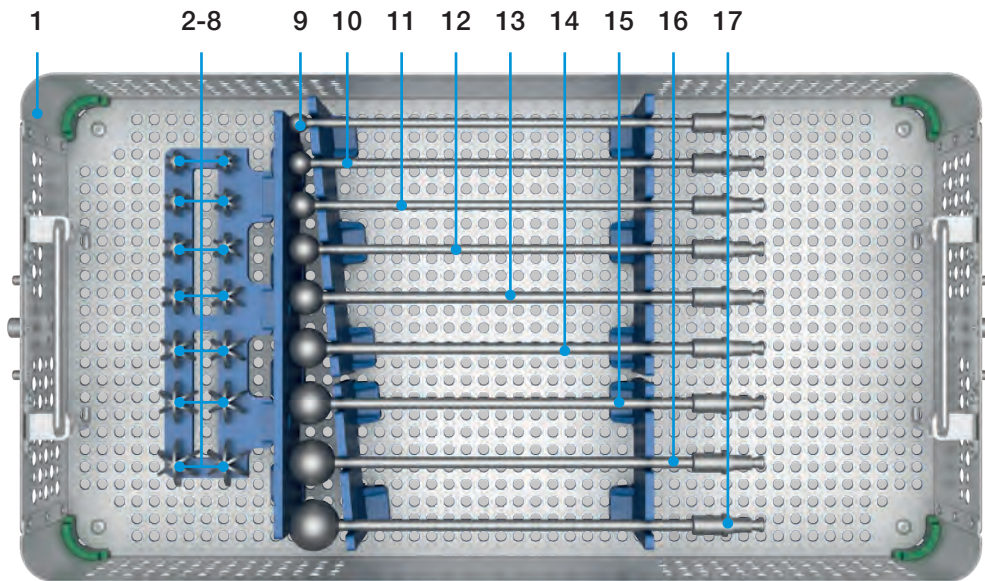

			Qty.
1	151-07/07	Ball Reamers & Trial Centralizers Tray	1
2	151-106/12	Trial Centralizer, 12 mm	2
3	151-106/14	Trial Centralizer, 14 mm	2
4	151-106/16	Trial Centralizer, 16 mm	2
5	151-106/18	Trial Centralizer, 18 mm	2
6	151-106/20	Trial Centralizer, 20 mm	2
7	151-106/22	Trial Centralizer, 22 mm	2
8	151-106/24	Trial Centralizer, 24 mm	2
9	15-1133/02B	Ball Reamer, 10 mm	1
10	15-1133/03B	Ball Reamer, 12 mm	1
11	15-1133/04B	Ball Reamer, 14 mm	1
12	15-1133/05B	Ball Reamer, 16 mm	1
13	15-1133/06B	Ball Reamer, 18 mm	1
14	15-1133/07B	Ball Reamer, 20 mm	1
15	15-1133/08B	Ball Reamer, 22 mm	1
16	15-1133/09B	Ball Reamer, 24 mm	1
17	15-1133/10B	Ball Reamer, 26 mm	1

151-08/00 Conical Cemented Stem Trials – Yellow feet

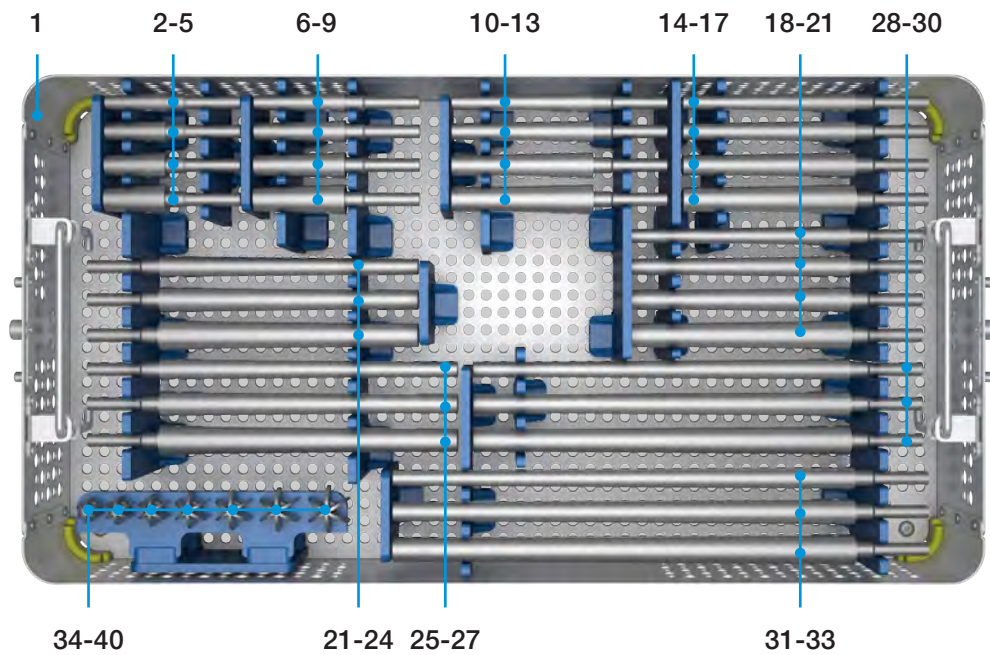

			Qty.
1	151-08/08	Conical Cemented Stem Trials Tray	1
2	151-080/10	Trial Stem Conical Cemented, Ø 10 mm, 80 mm	1
3	151-080/11	Trial Stem Conical Cemented, Ø 11 mm, 80 mm	1
4	151-080/13	Trial Stem Conical Cemented, Ø 13 mm, 80 mm	1
5	151-080/15	Trial Stem Conical Cemented, Ø 15 mm, 80 mm	1
6	151-095/10	Trial Stem Conical Cemented, Ø 10 mm, 95 mm	1
7	151-095/11	Trial Stem Conical Cemented, Ø 11 mm, 95 mm	1
8	151-095/13	Trial Stem Conical Cemented, Ø 13 mm, 95 mm	1
9	151-095/15	Trial Stem Conical Cemented, Ø 15 mm, 95 mm	1
10	151-120/10	Trial Stem Conical Cemented, Ø 10 mm, 120 mm	1
11	151-120/11	Trial Stem Conical Cemented, Ø 11 mm, 120 mm	1
12	151-120/13	Trial Stem Conical Cemented, Ø 13 mm, 120 mm	1
13	151-120/15	Trial Stem Conical Cemented, Ø 15 mm, 120 mm	1
14	151-135/10	Trial Stem Conical Cemented, Ø 10 mm, 135 mm	1
15	151-135/11	Trial Stem Conical Cemented, Ø 11 mm, 135 mm	1
16	151-135/13	Trial Stem Conical Cemented, Ø 13 mm, 135 mm	1
17	151-135/15	Trial Stem Conical Cemented, Ø 15 mm, 135 mm	1
18	151-160/10	Trial Stem Conical Cemented, Ø 10 mm, 160 mm	1
19	151-160/11	Trial Stem Conical Cemented, Ø 11 mm, 160 mm	1
20	151-160/13	Trial Stem Conical Cemented, Ø 13 mm, 160 mm	1
21	151-160/15	Trial Stem Conical Cemented, Ø 15 mm, 160 mm	1
22	151-180/11	Trial Stem Conical Cemented, Ø 11 mm, 180 mm	1
23	151-180/13	Trial Stem Conical Cemented, Ø 13 mm, 180 mm	1
24	151-180/15	Trial Stem Conical Cemented, Ø 15 mm, 180 mm	1
25	151-200/11	Trial Stem Conical Cemented, Ø 11 mm, 200 mm	1
26	151-200/13	Trial Stem Conical Cemented, Ø 13 mm, 200 mm	1
27	151-200/15	Trial Stem Conical Cemented, Ø 15 mm, 200 mm	1
28	151-240/11	Trial Stem Conical Cemented, Ø 11 mm, 240 mm	1
29	151-240/13	Trial Stem Conical Cemented, Ø 13 mm, 240 mm	1
30	151-240/15	Trial Stem Conical Cemented, Ø 15 mm, 240 mm	1
31	151-280/11	Trial Stem Conical Cemented, Ø 11 mm, 280 mm	1
32	151-280/13	Trial Stem Conical Cemented, Ø 13 mm, 280 mm	1
33	151-280/15	Trial Stem Conical Cemented, Ø 15 mm, 280 mm	1
34	151-050/12	Trial Stem Conical Cemented, Ø 11 mm with Ø 12 mm Centralizer, 50 mm	1
35	151-050/14	Trial Stem Conical Cemented, Ø 11 mm with Ø 14 mm Centralizer, 50 mm	1
36	151-050/16	Trial Stem Conical Cemented, Ø 11 mm with Ø 16 mm Centralizer, 50 mm	1
37	151-050/18	Trial Stem Conical Cemented, Ø 11 mm with Ø 18 mm Centralizer, 50 mm	1
38	151-050/20	Trial Stem Conical Cemented, Ø 11 mm with Ø 20 mm Centralizer, 50 mm	1
39	151-050/22	Trial Stem Conical Cemented, Ø 11 mm with Ø 22 mm Centralizer, 50 mm	1
40	151-050/24	Trial Stem Conical Cemented, Ø 11 mm with Ø 24 mm Centralizer, 50 mm	1

151-09/00 Conical Cementless Stem Instruments & Trials, 128 mm – Yellow feet

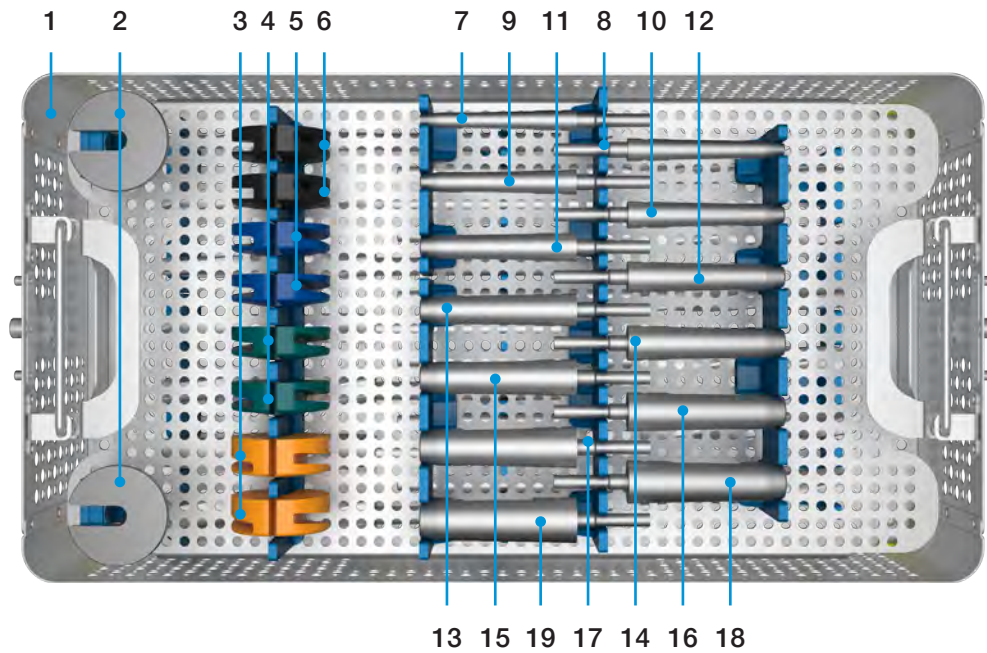

			Qty.
1	151-09/09	Conical Cementless Stem Instruments & Trials, 128 mm Tray – Upper Tray	1
2	151-718/00	Reamer Stopper, Tibia, XS-L	2
3	151-719/00	Reamer Stopper, Femur, XS	2
4	151-719/01	Reamer Stopper, Femur, S	2
5	151-719/02	Reamer Stopper, Femur, M	2
6	151-719/03	Reamer Stopper, Femur, L	2
7	151-100/12	Trial Stem Conical, Cementless, 128 mm, Ø 12 mm	1
8	151-100/13	Trial Stem Conical, Cementless, 128 mm, Ø 13 mm	1
9	151-100/14	Trial Stem Conical, Cementless, 128 mm, Ø 14 mm	1
10	151-100/15	Trial Stem Conical, Cementless, 128 mm, Ø 15 mm	1
11	151-100/16	Trial Stem Conical, Cementless, 128 mm, Ø 16 mm	1
12	151-100/17	Trial Stem Conical, Cementless, 128 mm, Ø 17 mm	1
13	151-100/18	Trial Stem Conical, Cementless, 128 mm, Ø 18 mm	1
14	151-100/19	Trial Stem Conical, Cementless, 128 mm, Ø 19 mm	1
15	151-100/20	Trial Stem Conical, Cementless, 128 mm, Ø 20 mm	1
16	151-100/21	Trial Stem Conical, Cementless, 128 mm, Ø 21 mm	1
17	151-100/22	Trial Stem Conical, Cementless, 128 mm, Ø 22 mm	1
18	151-100/23	Trial Stem Conical, Cementless, 128 mm, Ø 23 mm	1
19	151-100/24	Trial Stem Conical, Cementless, 128 mm, Ø 24 mm	1

151-09/00 Conical Cementless Stem Instruments & Trials, 128 mm – Yellow feet

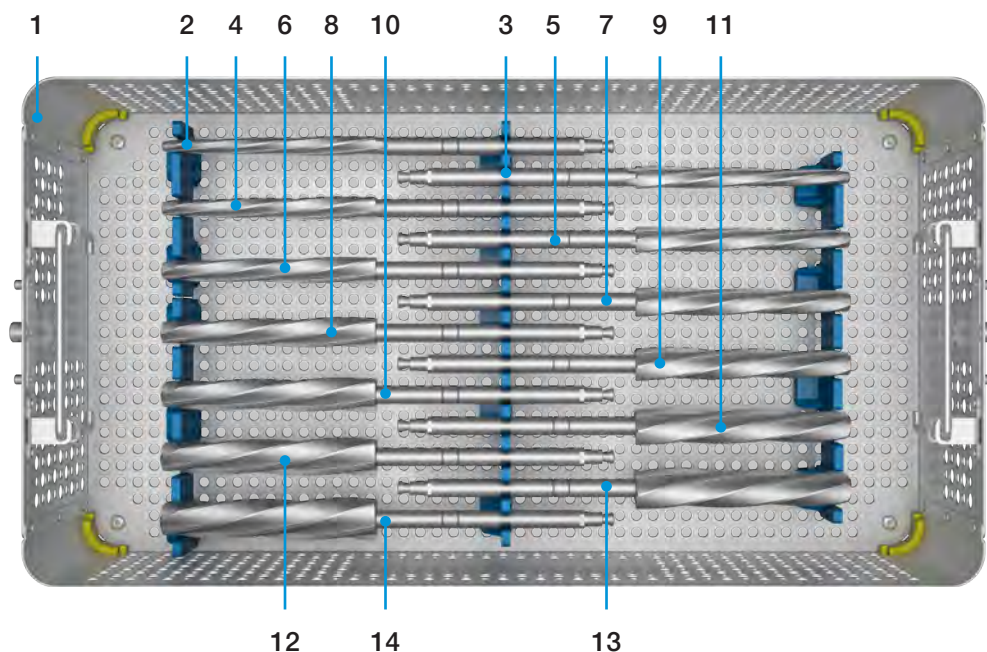

			Qty.
1	151-09/09	Conical Cementless Stem Instruments & Trials, 128 mm Tray – Lower Tray	1
2	151-610/12	Reamer Conical, 128 mm, Ø 12 mm	1
3	151-610/13	Reamer Conical, 128 mm, Ø 13 mm	1
4	151-610/14	Reamer Conical, 128 mm, Ø 14 mm	1
5	151-610/15	Reamer Conical, 128 mm, Ø 15 mm	1
6	151-610/16	Reamer Conical, 128 mm, Ø 16 mm	1
7	151-610/17	Reamer Conical, 128 mm, Ø 17 mm	1
8	151-610/18	Reamer Conical, 128 mm, Ø 18 mm	1
9	151-610/19	Reamer Conical, 128 mm, Ø 19 mm	1
10	151-610/20	Reamer Conical, 128 mm, Ø 20 mm	1
11	151-610/21	Reamer Conical, 128 mm, Ø 21 mm	1
12	151-610/22	Reamer Conical, 128 mm, Ø 22 mm	1
13	151-610/23	Reamer Conical, 128 mm, Ø 23 mm	1
14	151-610/24	Reamer Conical, 128 mm, Ø 24 mm	1

151-10/00 Conical Cementless Stem Instruments & Trials, 158 mm – Yellow feet

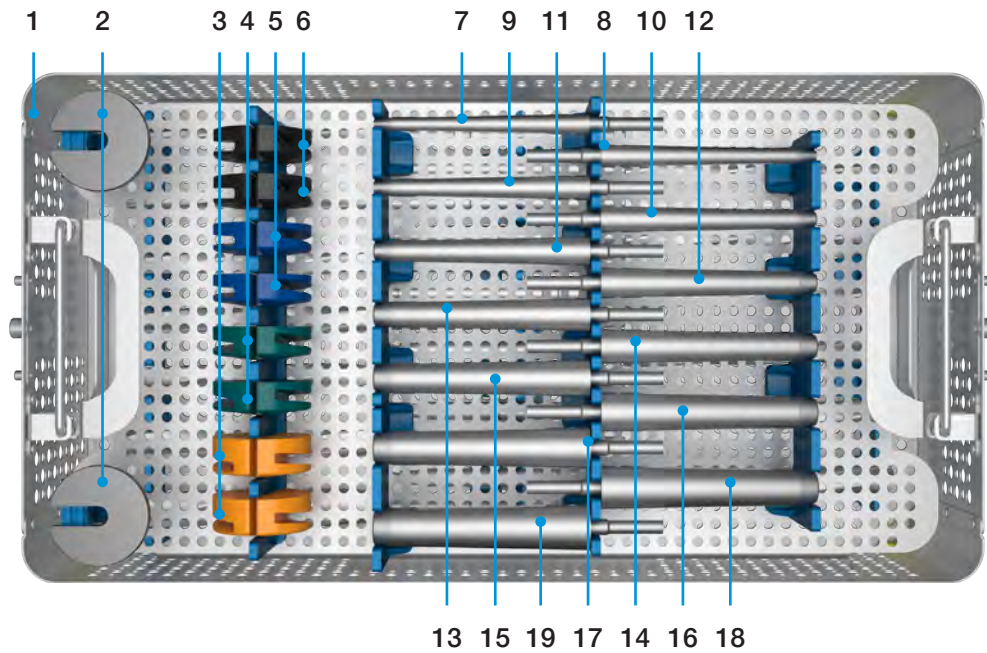

			Qty.
1	151-10/10	Conical Cementless Stem Instruments & Trials, 158 mm Tray – Upper Tray	1
2	151-718/00	Reamer Stopper, Tibia, XS-L	2
3	151-719/00	Reamer Stopper, Femur, XS	2
4	151-719/01	Reamer Stopper, Femur, S	2
5	151-719/02	Reamer Stopper, Femur, M	2
6	151-719/03	Reamer Stopper, Femur, L	2
7	151-130/12	Trial Stem Conical, Cementless, 158 mm, Ø 12 mm	1
8	151-130/13	Trial Stem Conical, Cementless, 158 mm, Ø 13 mm	1
9	151-130/14	Trial Stem Conical, Cementless, 158 mm, Ø 14 mm	1
10	151-130/15	Trial Stem Conical, Cementless, 158 mm, Ø 15 mm	1
11	151-130/16	Trial Stem Conical, Cementless, 158 mm, Ø 16 mm	1
12	151-130/17	Trial Stem Conical, Cementless, 158 mm, Ø 17 mm	1
13	151-130/18	Trial Stem Conical, Cementless, 158 mm, Ø 18 mm	1
14	151-130/19	Trial Stem Conical, Cementless, 158 mm, Ø 19 mm	1
15	151-130/20	Trial Stem Conical, Cementless, 158 mm, Ø 20 mm	1
16	151-130/21	Trial Stem Conical, Cementless, 158 mm, Ø 21 mm	1
17	151-130/22	Trial Stem Conical, Cementless, 158 mm, Ø 22 mm	1
18	151-130/23	Trial Stem Conical, Cementless, 158 mm, Ø 23 mm	1
19	151-130/24	Trial Stem Conical, Cementless, 158 mm, Ø 24 mm	1

151-10/00 Conical Cementless Stem Instruments & Trials, 158 mm – Yellow feet

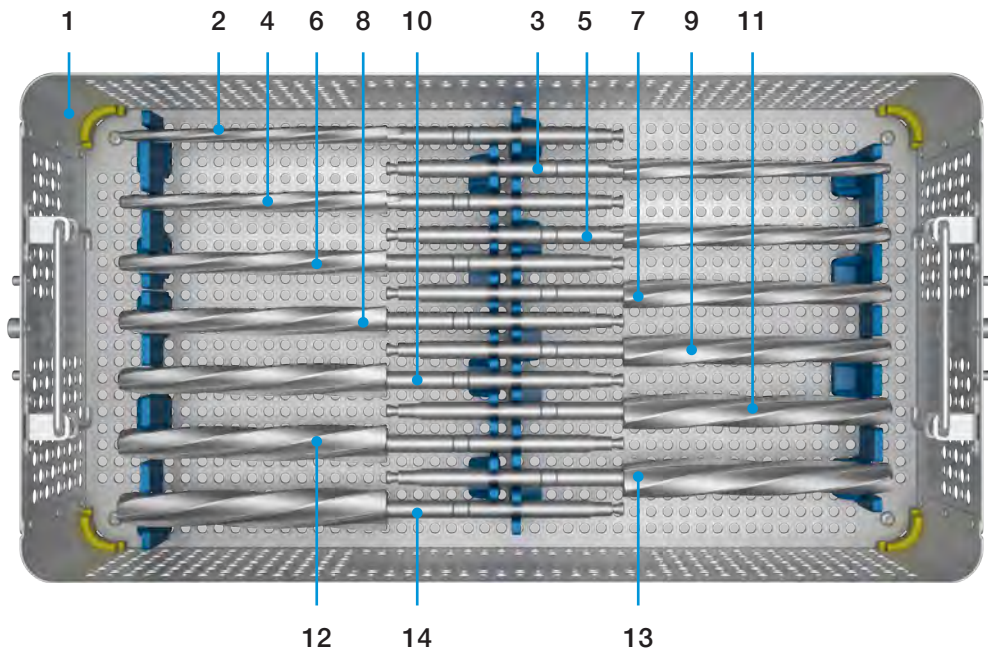

			Qty.
1	151-10/10	Conical Cementless Stem Instruments & Trials, 158 mm Tray – Lower Tray	1
2	151-613/12	Reamer Conical, 158 mm, Ø 12 mm	1
3	151-613/13	Reamer Conical, 158 mm, Ø 13 mm	1
4	151-613/14	Reamer Conical, 158 mm, Ø 14 mm	1
5	151-613/15	Reamer Conical, 158 mm, Ø 15 mm	1
6	151-613/16	Reamer Conical, 158 mm, Ø 16 mm	1
7	151-613/17	Reamer Conical, 158 mm, Ø 17 mm	1
8	151-613/18	Reamer Conical, 158 mm, Ø 18 mm	1
9	151-613/19	Reamer Conical, 158 mm, Ø 19 mm	1
10	151-613/20	Reamer Conical, 158 mm, Ø 20 mm	1
11	151-613/21	Reamer Conical, 158 mm, Ø 21 mm	1
12	151-613/22	Reamer Conical, 158 mm, Ø 22 mm	1
13	151-613/23	Reamer Conical, 158 mm, Ø 23 mm	1
14	151-613/24	Reamer Conical, 158 mm, Ø 24 mm	1

151-11/00 Conical Cementless Stem Instruments & Trials, 188 mm – Yellow feet

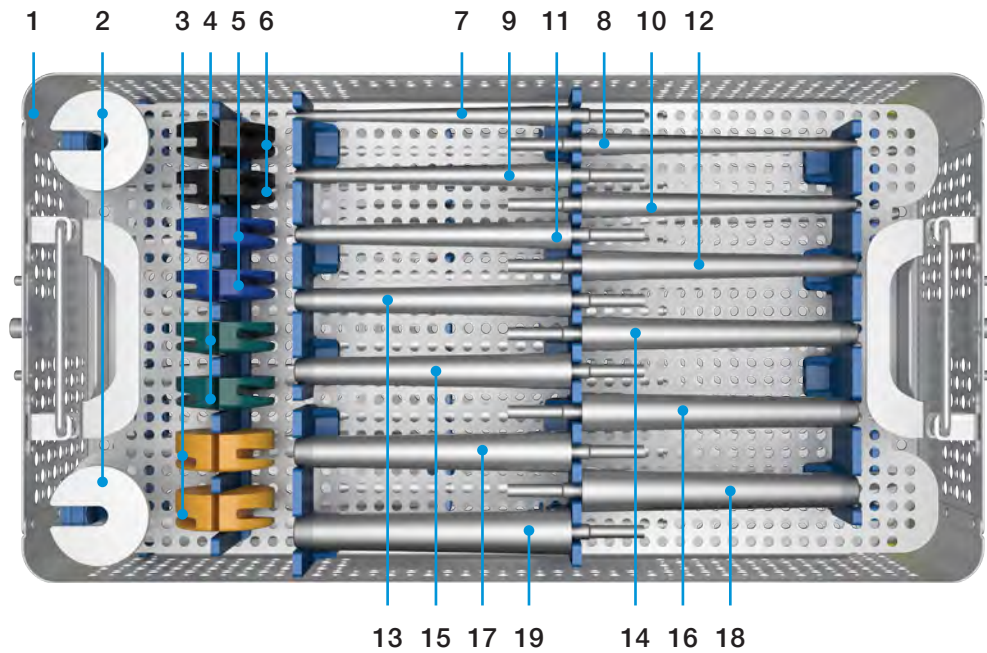

			Qty.
1	151-11/11	Conical Cementless Stem Instruments & Trials, 188 mm Tray – Upper Tray	1
2	151-718/00	Reamer Stopper, Tibia, XS-L	2
3	151-719/00	Reamer Stopper, Femur, XS	2
4	151-719/01	Reamer Stopper, Femur, S	2
5	151-719/02	Reamer Stopper, Femur, M	2
6	151-719/03	Reamer Stopper, Femur, L	2
7	151-160/12	Trial Stem Conical, Cementless, 188 mm, Ø 12 mm	1
8	151-160/13	Trial Stem Conical, Cementless, 188 mm, Ø 13 mm	1
9	151-160/14	Trial Stem Conical, Cementless, 188 mm, Ø 14 mm	1
10	151-160/15	Trial Stem Conical, Cementless, 188 mm, Ø 15 mm	1
11	151-160/16	Trial Stem Conical, Cementless, 188 mm, Ø 16 mm	1
12	151-160/17	Trial Stem Conical, Cementless, 188 mm, Ø 17 mm	1
13	151-160/18	Trial Stem Conical, Cementless, 188 mm, Ø 18 mm	1
14	151-160/19	Trial Stem Conical, Cementless, 188 mm, Ø 19 mm	1
15	151-160/20	Trial Stem Conical, Cementless, 188 mm, Ø 20 mm	1
16	151-160/21	Trial Stem Conical, Cementless, 188 mm, Ø 21 mm	1
17	151-160/22	Trial Stem Conical, Cementless, 188 mm, Ø 22 mm	1
18	151-160/23	Trial Stem Conical, Cementless, 188 mm, Ø 23 mm	1
19	151-160/24	Trial Stem Conical, Cementless, 188 mm, Ø 24 mm	1

151-11/00 Conical Cementless Stem Instruments & Trials, 188 mm – Yellow feet

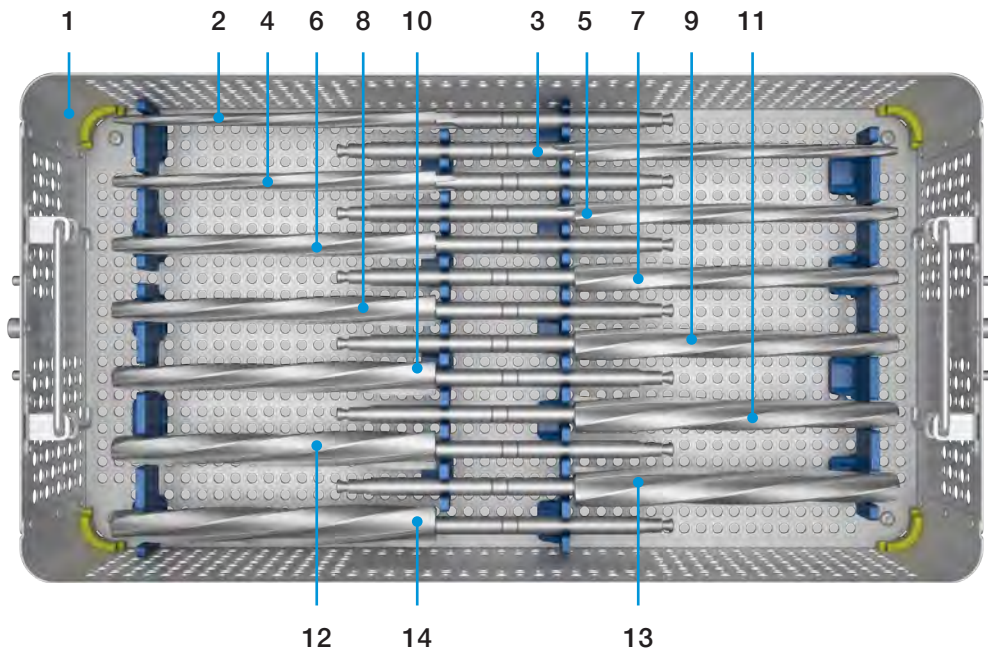

			Qty.
1	151-11/11	Conical Cementless Stem Instruments & Trials, 188 mm Tray – Lower Tray	1
2	151-616/12	Reamer Conical, 188 mm, Ø 12 mm	1
3	151-616/13	Reamer Conical, 188 mm, Ø 13 mm	1
4	151-616/14	Reamer Conical, 188 mm, Ø 14 mm	1
5	151-616/15	Reamer Conical, 188 mm, Ø 15 mm	1
6	151-616/16	Reamer Conical, 188 mm, Ø 16 mm	1
7	151-616/17	Reamer Conical, 188 mm, Ø 17 mm	1
8	151-616/18	Reamer Conical, 188 mm, Ø 18 mm	1
9	151-616/19	Reamer Conical, 188 mm, Ø 19 mm	1
10	151-616/20	Reamer Conical, 188 mm, Ø 20 mm	1
11	151-616/21	Reamer Conical, 188 mm, Ø 21 mm	1
12	151-616/22	Reamer Conical, 188 mm, Ø 22 mm	1
13	151-616/23	Reamer Conical, 188 mm, Ø 23 mm	1
14	151-616/24	Reamer Conical, 188 mm, Ø 24 mm	1

881-009/00 Patella Instruments & Trials – Blue feet

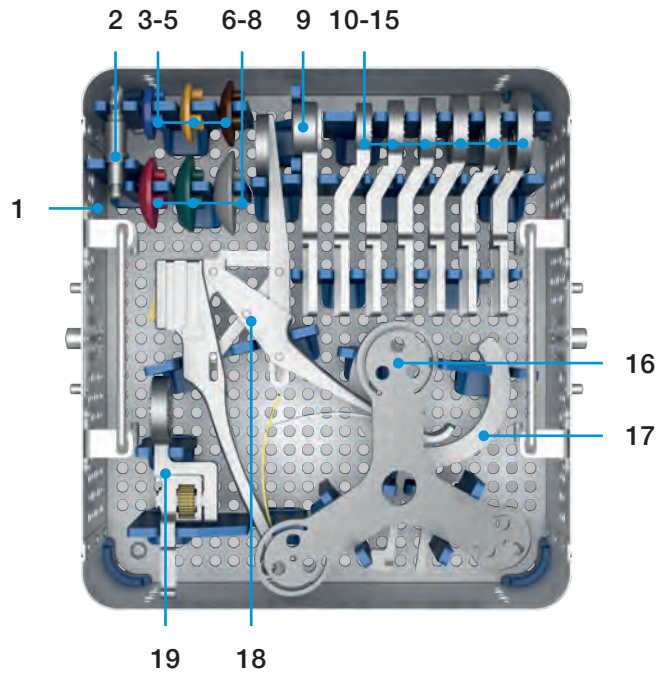

			Qty.
1	881-090/00	LinkSymphoKnee Patella Instruments & Trials Tray	1
2	881-012/00	Universal Drill, Hudson Fitting (B)	1
3	881-501/25	Patella Trial, Ø 25 mm, H = 6 mm	1
4	881-501/28	Patella Trial, Ø 28 mm, H = 6 mm	1
5	881-501/31	Patella Trial, Ø 31 mm, H = 7 mm	1
6	881-501/34	Patella Trial, Ø 34 mm, H = 8 mm	1
7	881-501/37	Patella Trial, Ø 37 mm, H = 9 mm	1
8	881-501/40	Patella Trial, Ø 40 mm, H = 10 mm	1
9	445-904/00	Patella Clamp, Clamp Arm	1
10	881-511/25	Patella Drill Guide, Ø 25 mm	1
11	881-511/28	Patella Drill Guide, Ø 28 mm	1
12	881-511/31	Patella Drill Guide, Ø 31 mm	1
13	881-511/34	Patella Drill Guide, Ø 34 mm	1
14	881-511/37	Patella Drill Guide, Ø 37 mm	1
15	881-511/40	Patella Drill Guide, Ø 40 mm	1
16	881-509/00	Patella Sizing Template	1
17	445-903/00	Patella Clamp, Resection Guide	1
18	445-902/00	Patella Clamp, Handle	1
19	881-500/00	Patella Depth Gauge	1

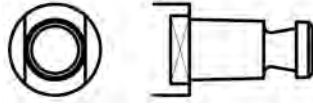

Additional Instruments

Hudson Fitting (B)
Standard tool connection.





Adapter for power tool chuck

Different adapters are available to ensure compatibility to allow various connections:

REF	Attachment	
16-3283/01	Jakobs Fitting (E)	
16-3284/00	AO Fitting (D)	
16-3285/00	Harris Fitting (C)	

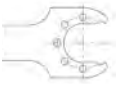

Sawblades,
without offset teeth, 1.24 mm thick

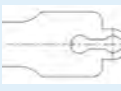
Width (A) 25 mm	Width (A) 13 mm	Fitting	
317-654/10	317-656/10	Synthes	
317-654/11	317-656/11	Aesculap Combi	
317-654/13	317-656/13	Zimmer / Hall Combi	
317-654/14	317-656/14	Stryker System 4	

X-ray Templates

REF	X-ray templates for LinkSymphoKnee CCK
881-750/00	To be used with LinkSymphoKnee CCK, 110% actual size

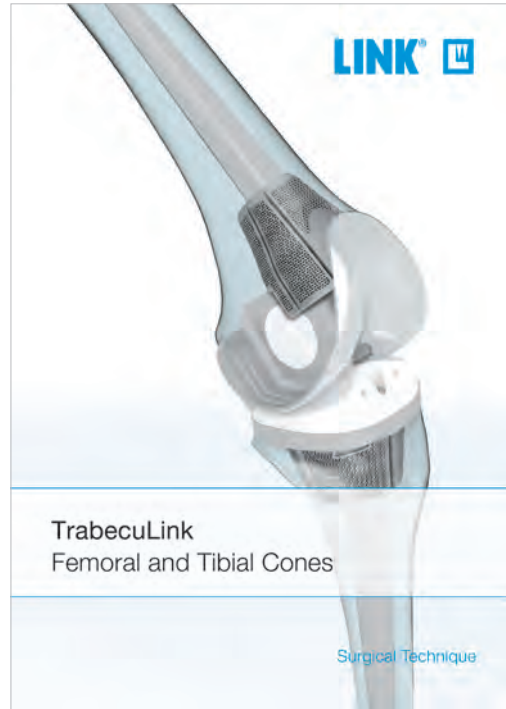

For more information please register for our LINK Media Library (linkorthopaedics.com)

Specified Indications and Contraindications: <i>LinkSymphoKnee</i> System
LinkSymphoKnee Cruciate Retaining Fixed Bearing (CR FB)
Indications:
Any form of uni-, bi- or tricompartmental arthritis of the knee joint (e.g. primary degenerative arthritis, secondary arthritis resulting from rheumatoid arthritis, fracture, post-infection, gout, chondrocalcinosis and others)
Contraindications (absolute):
Acute and chronic infections, local and systemic, insofar as they may compromise the successful implantation
Moderate or severe instability or complete loss of the medial or collateral ligament
Instability or loss of the posterior cruciate ligament
Any bone defect that will result in insufficient implant fixation (based on the fact, that using stems, bone grafts and metal bone substitutes like cones, a minimum bone stock for implant fixation cannot be defined)
Severe insufficiency or loss of extensor mechanism
Contraindications (relative):
Extension deficit >30°
Varus or valgus deformity >30°
Allergy to one of the implant materials
LinkSymphoKnee Posterior Stabilized Fixed Bearing and All-Poly (PS FB and PS All-Poly)
Indications:
Any form of uni-, bi- or tricompartmental arthritis of the knee joint (e.g. primary degenerative arthritis, secondary arthritis resulting from rheumatoid arthritis, fracture, post-infection, gout, chondrocalcinosis and others)
Contraindications (absolute):
Acute and chronic infections, local and systemic, insofar as they may compromise the successful implantation
Moderate or severe instability or complete loss of the medial or collateral ligament
Any bone defect that will result in insufficient implant fixation (based on the fact, that using stems, bone grafts and metal bone substitutes like cones, a minimum bone stock for implant fixation cannot be defined)
Severe insufficiency or loss of extensor mechanism
Contraindications (relative):
Allergy to one of the implant materials
LinkSymphoKnee Posterior Stabilized Plus Fixed Bearing (PS+ FB)
Indications:
Any form of uni-, bi- or tricompartmental arthritis of the knee joint (e.g. primary degenerative arthritis, secondary arthritis resulting from rheumatoid arthritis, fracture, post-infection, gout, chondrocalcinosis and others)
Contraindications (absolute):
Acute and chronic infections, local and systemic, insofar as they may compromise the successful implantation
Severe instability or complete loss of the medial or collateral ligament
Any bone defect that will result in insufficient implant fixation (based on the fact, that using stems, bone grafts and metal bone substitutes like cones, a minimum bone stock for implant fixation cannot be defined)
Severe insufficiency or loss of extensor mechanism
Contraindications (relative):
Situations in which an overall leg alignment will result, that is outside a range of 5° varus or valgus in reference to the mechanical axis. In such a situation the PS+ mechanism may fail over time as a result of the shear forces
Allergy to one of the implant materials
LinkSymphoKnee Condylar Constrained Knee Fixed Bearing (CCK FB)
Indications:
Any form of uni-, bi- or tricompartmental arthritis of the knee joint (e.g. primary degenerative arthritis, secondary arthritis resulting from rheumatoid arthritis, fracture, post-infection, gout, chondrocalcinosis and others)
Contraindications (absolute):
Acute and chronic infections, local and systemic, insofar as they may compromise the successful implantation
Complete loss of the medial or collateral ligament
Any bone defect that will result in insufficient implant fixation (based on the fact, that using stems, bone grafts and metal bone substitutes like cones, a minimum bone stock for implant fixation cannot be defined)
Severe insufficiency or loss of extensor mechanism
Contraindications (relative):
Situations in which an overall leg alignment will result, that is outside a range of 5° varus or valgus in reference to the mechanical axis. In such a situation the CC mechanism may fail over time as a result of the shear forces
Allergy to one of the implant materials

Implants with TiN₂-Coating

In contrast to all other implants an allergy against one of the implant materials is not a contraindication. Otherwise the above mentioned indications and contraindications depending on the design of the TiN₂-coated implants remain the same.

Please note:

These indications/contraindications refer to standard cases. The ultimate decision on whether or not an implant is suitable for a patient must be made by the surgeon based on his/her individual analysis and his/her experience.

Please note the following regarding the use of our implants:

1. Choosing the right implant is very important.

The size and shape of the human bone determines the size and shape of the implant and also limits the load capacity. Implants are not designed to withstand unlimited physical stress. Demands should not exceed normal functional loads.

2. Correct handling of the implant is very important.

Under no circumstances should the shape of a finished implant be altered, as this shortens its life span. Our implants must not be combined with implants from other manufacturers. The instruments indicated in the Surgical Technique must be used to ensure safe implantation of the components.

3. Implants must not be reused.

Implants are supplied sterile and are intended for single use only. Used implants must not be used again.

4. After-treatment is also very important.

The patient must be informed of the limitations of the implant. The load capacity of an implant cannot compare with that of healthy bone!

5. Unless otherwise indicated, implants are supplied in sterile packaging.

Note the following conditions for storage of packaged implants:

- Avoid extreme or sudden changes in temperature.
- Sterile implants in their original, intact protective packaging may be stored in permanent buildings up until the "Use by" date indicated on the packaging.
- They must not be exposed to frost, dampness or direct sunlight, or mechanical damage.
- Implants may be stored in their original packaging for up to 5 years after the date of manufacture. The "Use by" date is indicated on the product label.
- Do not use an implant if the packaging is damaged.

6. Traceability is important.

Please use the documentation stickers provided to ensure traceability.

7. Further information on the material composition is available on request from the manufacturer.

Follow the instructions for use!

Waldemar Link GmbH & Co. KG, Hamburg

All content in this catalog, including text, pictures and data, is protected by law. Every instance of use, whether in part or in whole and which is not permitted by law, is subject to our prior consent. In particular, this applies to the reproduction, editing, translation, publishing, saving, processing, or passing on of content stored in databases or other electronic media and systems, in any manner or form. The information in the catalogs is solely intended to describe the products and does not constitute a guarantee.

The Surgical Technique described has been written to the best of our knowledge and belief, but it does not relieve the surgeon of his/her responsibility to duly consider the particularities of each individual case.

Products shown in this document may not be available in your country. The product availability is subject to the approval and/or registration regulations of the respective country. Please contact Waldemar Link GmbH & Co. KG if you have questions about the availability of LINK products in your country.

Waldemar Link GmbH & Co. KG and/or other corporate affiliated entities own, use or have applied for the following trademarks in many jurisdictions: LINK, BiMobile, SP II, Modell Lubinus, E-Dur, EndoDur, T.O.P. II, BetaCup, CombiCup PF, CombiCup SC, CombiCup R, MobileLink, C.F.P., LCU, SP-CL, LCP, MIT-H, Endo-Model, Endo-Model SL, MP, MEGASYSTEM-C, GEMINI SL, SPAR-K, LCK, HX, TiCaP, X-LINKed, PorAg, LINK PorEx, BiPorEx, PorEx-Z, TrabecuLink, Tilastan, customLINK, RescueSleeve, Stactip, VACUCAST.

Other trademarks and trade names may be used in this document to refer to either the entities claiming the marks and/or names or their products and are the property of their respective owners.



Waldemar Link GmbH & Co. KG

Barkhausenweg 10 · 22339 Hamburg · Germany
Phone +49 40 53995-0 · info@linkhh.de
www.linkorthopaedics.com

