





LinkSymphoKnee

CR, PS & PS+

Surgical Technique

CE 0482

Explanation of Pictograms			
	Manufacturer		Article number
	Material (number)		Product meets the applicable requirements, which are regulated in the EU harmonization legislation for the affixing of the CE marking.

LinkSymphoKnee



CR, PS & PS+

02	Overview – Workflow of Surgical Steps:
	- Distal Cut First
	- Tibia First
	- Femur First
	Surgical Technique:
04	Preoperative Planning
05	Approaches
06	Pins, Pin Instruments and Sawblades
08	Determination of the Femoral Resection Level
09	Femoral Alignment Guide Assembly
10	Femoral Intramedullary Alignment
13	Distal Femoral Resection
14	Extramedullary Tibial Guide
18	Tibial Resection
19	Checking Extension Gap and Axes
20	Femoral Sizing and Rotation
23	Femoral 4-in-1 Resection:
25	Repositioning of the 4-in-1 Femoral Cutting Block
26	Femoral 4-in-1 Resection
27	Femoral Box Preparation
29	Tibial Sizing
30	Tibial Preparation
32	Patella Preparation (Patella Resurfacing)
35	Trial Reduction and Functional Test
39	Final Implantation – Modular Tibia Base
40	1 Fixed Bearing Tibial Component Implantation
41	2 Femoral Component Implantation
42	3 Fixed Bearing PE Articulating Surface
44	Patella Implantation
45	Functional Test
46	Appendix 1, Intramedullary Tibial Guide
49	Appendix 2, All-Poly Tibia PS
51	Appendix 3, CCK Femoral Preparation
57	Appendix 4, Valgus/Varus Tibial Recut
	Implants:
58	Implants Combination Overview
60	LinkSymphoKnee Femoral Components
70	LinkSymphoKnee Tibial Components
73	LinkSymphoKnee Taper Caps, Patella Components
74	LinkSymphoKnee Articulating Surfaces
82	LinkSymphoKnee Cemented Stems, Centralizers
83	LinkSymphoKnee Replacement Sets
	Instruments:
84	LinkSymphoKnee Instrument Sets: Overview
107	Additional Instruments
108	X-ray Templates
109	Additional Information
110	Indications/Contraindications
	Important Information

NOTE: To assist the reader of this Surgical Technique, the LinkSymphoKnee instruments used in the illustrated surgical steps are shown again at the bottom of each page (from 08 to 57).

Take care to select the correct size of the instruments according to the individual surgical case.

Distal Cut First



Preoperative Planning (Approach)



Distal Femoral Resection



EM Tibial Alignment and Resection



IM Tibial Alignment and Resection



Tibia First



Preoperative Planning (Approach)



EM Tibial Alignment and Resection



IM Tibial Alignment and Resection



Distal Femoral Resection

Checking Extension Gap and Axes

Femur First



Preoperative Planning (Approach)



Distal Femoral Resection



A/P Femoral Resection and Chamfer Cuts

optional



Femoral Preparation PS/CCK



EM Tibial Alignment and Resection



IM Tibial Alignment and Resection



A/P Femoral Resection
and Chamfer Cuts

• optional



Femoral Preparation
PS/CCK

LinkSymphoKnee
CR, PS & PS+



Tibial Preparation



Trial Reduction and
Functional Test



Final Implantation

Preoperative Planning

The anatomic landmarks in the knee joint are defined preoperatively by imaging the whole leg on the healthy side and the affected side in the standing position. The angle between the anatomic axis (center of knee joint – intramedullary canal) and the mechanical axis (center of femoral head – center of knee joint – center of ankle to the second toe) determines the valgus angle **(01)**.

These angles should be determined for both knees. The valgus angle of a healthy knee joint is approximately 5° - 7° . In comparison with the healthy side, and for the purpose of reconstructing the corresponding valgus angle in the affected knee joint, this angle must be determined before carrying out the distal femoral resection. The appropriate implant size can be estimated preoperatively with X-ray Templates. The necessary resections are determined by the size of the implant and the deformity corrections required.

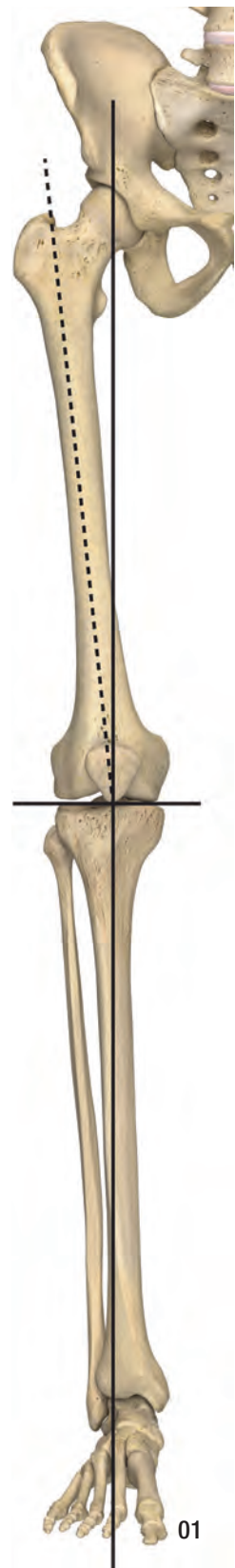

Approaches

With the knee in slight flexion, a straight incision is made over the patella, as far as the tibial tuberosity (02).

A medial parapatellar incision is made through the patellar retinaculum, capsule and synovial membrane (03).

When making the parapatellar incision, the patella is pushed to one side to visualize the patellofemoral joint. Removal of the hypertrophic synovial membrane and parts of the fat pad allows access to the medial, lateral and intracondylar parts of the joint. Excess synovium should be removed in order to avoid postoperative impingement and adhesions. Some surgeons prefer total synovectomy.



02



03

Alternative Approaches:

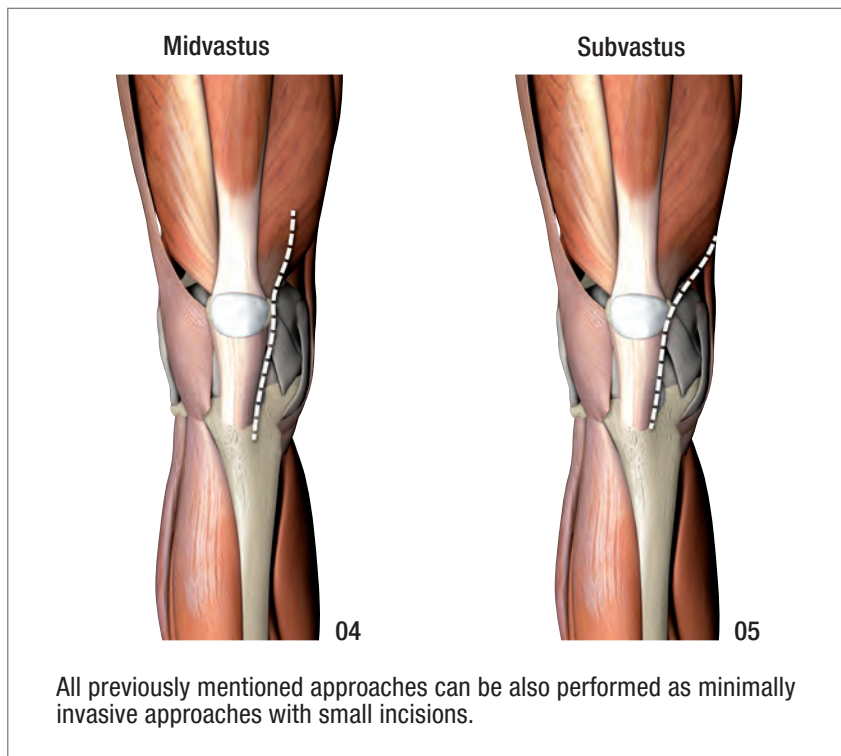

Pins, Pin Instruments and Sawblades

The *LinkSymphoKnee* Instruments are designed to be used with:

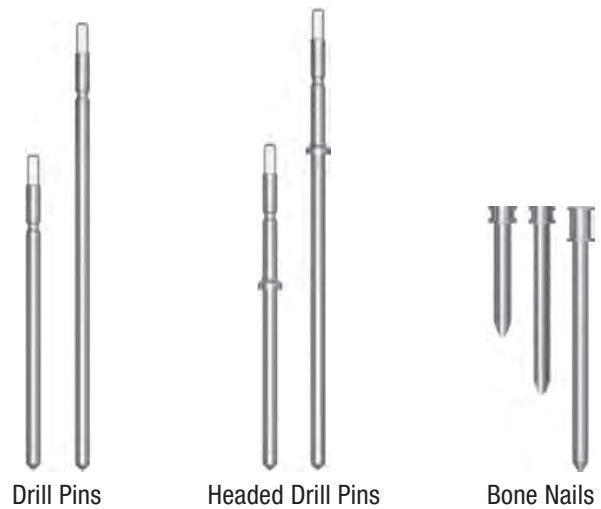

The Drill Pins, Headed Drill Pins and Bone Nails may be hammered in using the Universal Pin Inserter/Extractor (A) or the Universal Pin Inserter (B). The Drill Pins, Headed Drill Pins and Bone Nails may be pulled out using the Universal Pin Inserter/Extractor (A), the Drill Pins and Headed Drill Pins are also designed to be drilled in and removed using the Power Driver (C) or the Power Driver with Snap Lock (D). The Bone Nail may be pulled out using the Universal Pin Inserter/Extractor (A) or the Slaphammer (E).

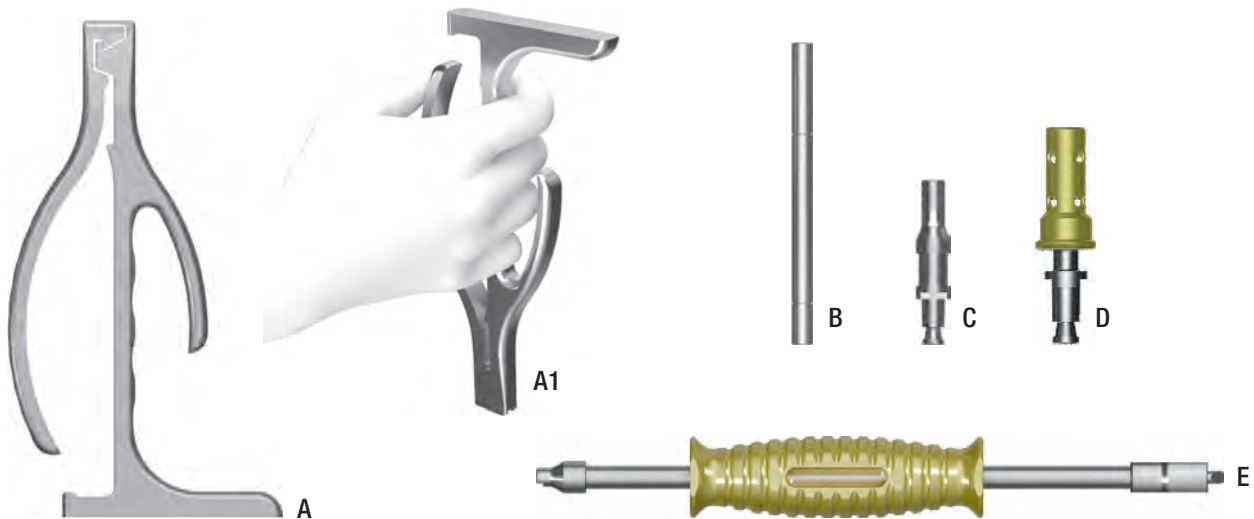

Use the Universal Pin Inserter/Extractor (A) as shown in the picture (A1).

OPTIONAL:











The *LinkSymphoKnee* Instruments are designed to be used also with Thread Pins*, headed or not headed.



ATTENTION: The Thread Pins* are designed to be drilled in and removed using the Power Driver (C) or the Power Driver with Snap Lock (D) only.

* only available upon request

The *LinkSymphoKnee* Instruments are designed for use with Sawblades up to a max. thickness of 1.27 mm (page 107).

<p>Compatibility</p>	 Drill Pins	 Headed Drill Pins	 Bone Nails	 Thread Pins*	 Headed Thread Pins*
 Universal Pin Inserter/Extractor	✓	✓	✓		
 Universal Pin Inserter	✓	✓	✓		
 Power Driver	✓	✓		✓	✓
 Power Driver with Snap Lock	✓	✓		✓	✓
 Slaphammer			✓		

* only available upon request

Determination of the Femoral Resection Level

For femoral preparation, the knee is flexed to 90°. The entry point for opening the femur can be marked with an electrocautery, as in illustration (06). It is usually located approx. 3-5 mm medially above the intercondylar fossa. The medullary canal is opened with the Step Drill (07).

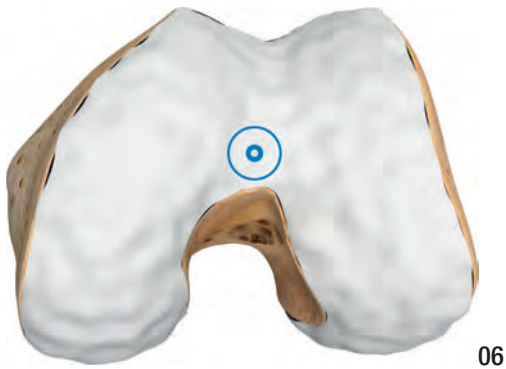

Instruments



319-505/00B
Step Drill

Femoral Alignment Guide Assembly

In order to lock the Femoral Cutting Block, Distal Cut with the Femoral Alignment Guide, twist the knob of the Femoral Alignment Guide, varus/valgus adjustment, clockwise until it clicks in the "lock position" (08).



Slide the Femoral Alignment Guide onto the Intramedullary Rod (09).



Instruments



445-104/00
Femoral Cutting Block,
distal cut



445-102/00
Femoral Alignment Guide,
varus/valgus adjustment



445-101/00
Intramedullary Rod

Femoral Intramedullary Alignment

Use preoperative X-rays to define the patient's appropriate mechanical axis. Set the valgus angle (left or right – 0° to 9°) on the Femoral Alignment Guide, varus/valgus adjustment, by rotating the appropriate knobs.

Rotate the knob marked with "L" for selecting the desired angle for a left knee (10).

Rotate the knob marked with "R" for selecting the desired angle for a right knee (11).

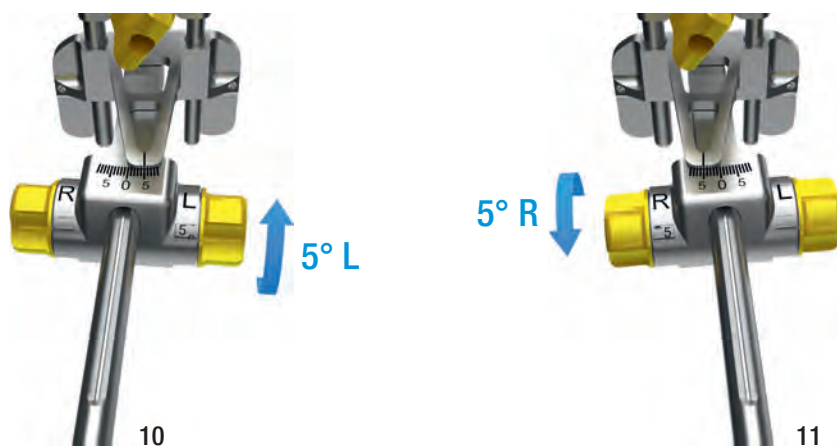

Slowly introduce the Intramedullary Rod with the Femoral Alignment Guide to prevent building up pressure in the canal. Insert it far enough to ensure the most accurate replication of the anatomic axis (12).



ATTENTION: Before fixing the Femoral Cutting Block with two pins, it must be ensured that at least one condyle is in contact with the alignment instrument, and that the valgus angle of the correct side has been set.

Instruments



445-104/00
Femoral Cutting Block,
distal cut



445-102/00
Femoral Alignment Guide,
varus/valgus adjustment



445-101/00
Intramedullary Rod

OPTIONAL: For additional fixation, impact a Bone Nail (13) on the medial or lateral side of the Femoral Alignment Guide until the head of the Bone Nail is flush with the plate.



OPTIONAL: To confirm the valgus angle, attach the Quick Connect Handle to the Femoral Cutting Block and then insert the Alignment Rod into the Quick Connect Handle. Extend the Alignment Rod assembly to the center of the femoral head (14).



Instruments



Alignment Rods:
445-113/10 short,
445-113/20 long



445-104/00
Femoral Cutting Block,
distal cut



445-112/00
Handle, quick connect



445-128/25
Bone Nail

The Alignment Rods are connected by inserting and twisting the pin of the long Alignment Rod into the slot of the short Alignment Rod (15+16).

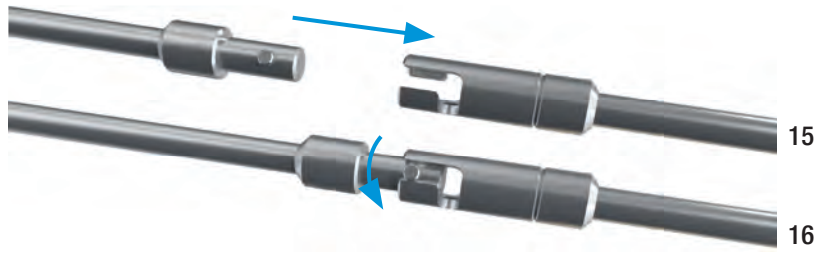

Insert a Drill Pin through each of the black circled pin holes (17a) on the anterior surface of the Femoral Cutting Block (17).



Release the knob of the Femoral Alignment Guide by rotating it counterclockwise. Remove the Femoral Alignment Guide together with the Intramedullary Rod and leave the Femoral Cutting Block in situ (18).



Instruments



Distal Femoral Resection

The Cutting Template can be used to check the level of the distal resection (19).



19

To fully secure the Femoral Cutting Block to the femur, two Headed Drill Pins are inserted into oblique holes (20).

Use an oscillating saw and a Sawblade (max. 1.27 mm thick) through the cut slot to resect the distal femur (21).



20

21

Remove the Cutting Block.

Instruments



445-104/00
Femoral Cutting Block,
distal cut



317-802/53
Cutting Template



445-124/65
Drill Pin



445-125/35
Headed Drill Pin

Extramedullary Tibial Guide

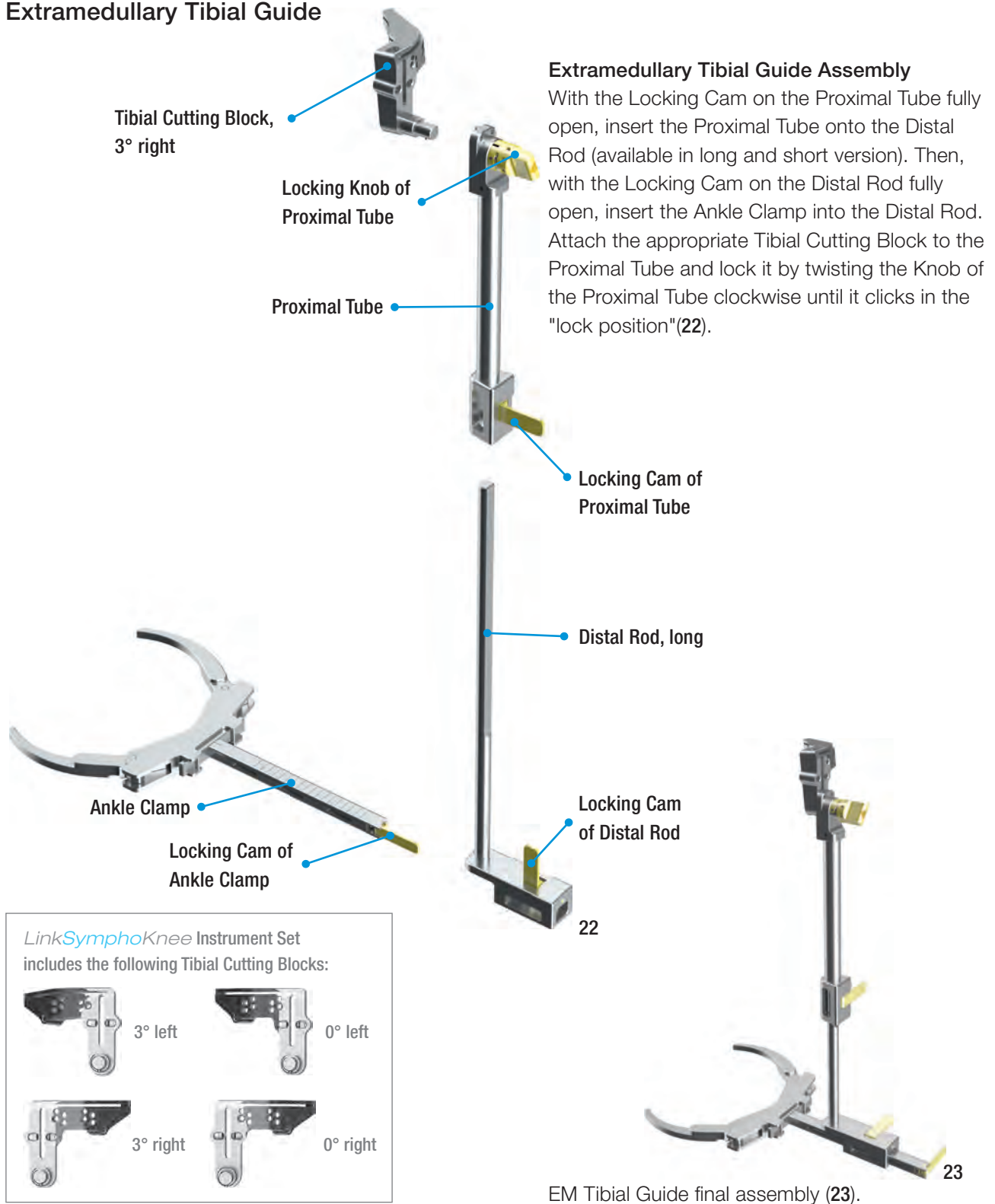

Extramedullary Tibial Guide Assembly

With the Locking Cam on the Proximal Tube fully open, insert the Proximal Tube onto the Distal Rod (available in long and short version). Then, with the Locking Cam on the Distal Rod fully open, insert the Ankle Clamp into the Distal Rod. Attach the appropriate Tibial Cutting Block to the Proximal Tube and lock it by twisting the Knob of the Proximal Tube clockwise until it clicks in the "lock position"(22).

Labels:

- Tibial Cutting Block, 3° right
- Locking Knob of Proximal Tube
- Proximal Tube
- Locking Cam of Proximal Tube
- Distal Rod, long
- Locking Cam of Distal Rod
- Ankle Clamp
- Locking Cam of Ankle Clamp

LinkSymphoKnee Instrument Set includes the following Tibial Cutting Blocks:

- 3° left
- 0° left
- 3° right
- 0° right

22

23

EM Tibial Guide final assembly (23).

Instruments

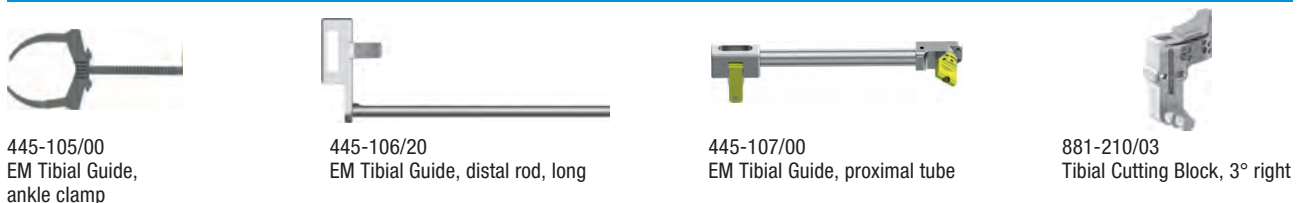

- 445-105/00 EM Tibial Guide, ankle clamp
- 445-106/20 EM Tibial Guide, distal rod, long
- 445-107/00 EM Tibial Guide, proximal tube
- 881-210/03 Tibial Cutting Block, 3° right



Extramedullary Tibial Guide Alignment

Position the knee at 90° of flexion with the tibia translated anteriorly and the whole leg held firmly in place on the surgical table. Place the Tibial Cutting Block against the proximal tibia. The Locking Cam on the Proximal Tube is used for macro-adjusting the height of the Tibial Cutting Block. Adjust the EM Tibial Guide to the approximate length of the tibia (24) by closing the Locking Cam.

Align the Proximal Tube with the medial aspect of the tibial tubercle to set the rotation.



OPTIONAL: In order to give the EM Tibial Guide additional stability, a Headed Drill Pin can be inserted through the center of the vertical slot on the Tibial Cutting Block. The central pin stabilizes the Tibial Cutting Block still allowing varus/valgus, posterior slope and resection level adjustments (25).

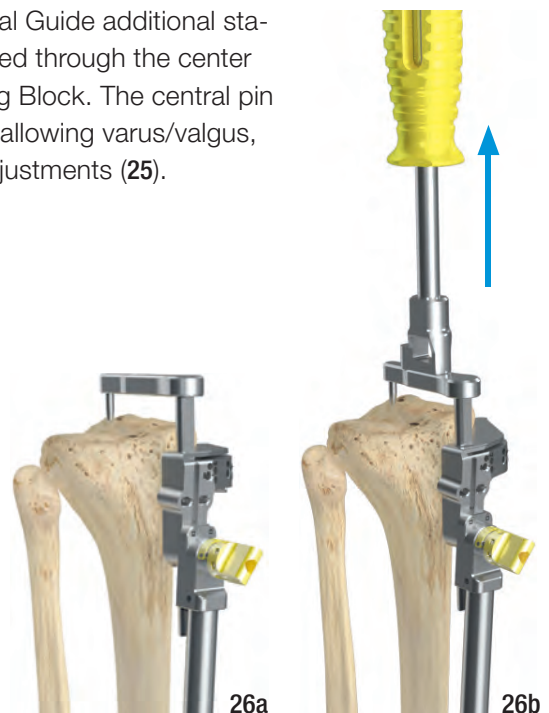

OPTIONAL: As an alternative to a Headed Drill Pin, the Spike Rod can be used to give the EM Tibial Guide additional stability (26a). Use the Slaphammer to remove or reposition the Spike Rod, if necessary (26b).

Instruments



Slope Adjustment

Adjust the slope of the EM Tibial Guide on the sagittal plane, releasing the Locking Cam on the Distal Rod (27). Insert the Cutting Template or a free blade into the slot of the Tibial Cutting Block to help assess the expected slope of the tibial resection.

ATTENTION: All *LinkSymphoKnee* Tibial Components feature a central stem tilted 3° posteriorly.



27

Varus/Valgus Adjustment

Adjust the varus/valgus alignment of the EM Tibial Guide by releasing the Locking Cam at the distal end of the Ankle Clamp (28). This adjustment allows the frontal alignment of the EM Tibial Guide, avoiding varus or valgus tibial resection.



28

Instruments



445-105/00
EM Tibial Guide,
ankle clamp



445-106/20
EM Tibial Guide, distal rod, long



445-107/00
EM Tibial Guide, proximal tube



881-210/03
Tibial Cutting Block, 3° right

Setting the Tibial Resection Level

Insert the foot of the Adjustable Stylus into the slot of the Tibial Cutting Block and adjust it to the appropriate level. Release the Locking Cam on the Proximal Tube to allow for micro-adjusting the height of the Tibial Cutting Block (29).



The scale on the body of the Adjustable Stylus indicates the amount of bone and residual cartilage to be resected (30).



ATTENTION:

Do not change the setting of the Adjustable Stylus while the instrument is in contact with the bone. Push the entire construct upwards, until the Stylus is not in contact anymore, and only then change the setting.

ATTENTION:

LinkSymphoKnee Fixed Bearing CR (Cruciate Retaining), Fixed Bearing PS (Posterior Stabilized), Fixed Bearing PS+ (Posterior Stabilized +) and All-Poly PS Tibial Component feature 10 mm of minimum tibial component thickness (tibial baseplate + PE articulating surface).

Set the Adjustable Stylus according to the patient's anatomic situation, to avoid excessive tibial resection. Confirm tibial resection level using Cutting Template introduced as a free saw blade into the Cutting Block.

Instruments



445-105/00
EM Tibial Guide,
ankle clamp



445-106/20
EM Tibial Guide, distal rod, long



445-107/00
EM Tibial Guide, proximal tube



881-210/03
Tibial Cutting Block,
3° right



445-111/00
Adjustable Stylus

Tibial Resection

After the tibial resection level has been set, close the Locking Cam on the EM Tibial Proximal Tube and pin the Tibial Cutting Block through the anterior parallel "0" holes, using two Drill Pins (31).

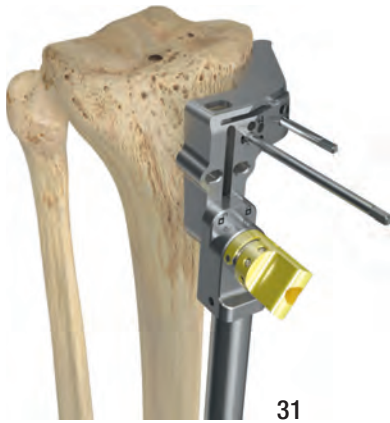

The resection level can be adjusted by repositioning the Tibial Cutting Block (proximal 2 mm, distal 2 mm or 4 mm). If desired, the cutting block can be more securely fixed with an additional Headed Drill Pin placed through the distal angled hole.

OPTIONAL: To assess tibial alignment, attach the Quick Connect Handle to the Tibial Cutting Block, and insert the Alignment Rod. The alignment can be checked by ensuring that the Alignment Rod remains parallel with the tibial axis (32).

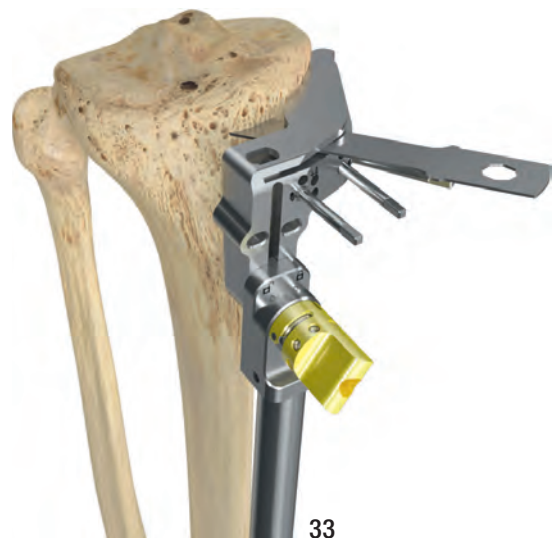

Resect the tibia (33).

Instruments



Checking Extension Gap and Axes



The Extension/Flexion Spacer (34a) can be connected to a 1 mm, 4 mm or 8 mm Shim to allow evaluation of higher thicknesses (34b):

- 10 mm + 1 mm Shim = 11 mm
- 10 mm + 4 mm Shim = 14 mm
- 12 mm + 4 mm Shim = 16 mm
- 10 mm + 8 mm Shim = 18 mm



ATTENTION: Use the the Extension/Flexion Spacer for Micro-Sizes in small knees

To check the extension gap, fully extend the leg and place the Extension/Flexion Spacer between the two resected surfaces. The extension gap should be rectangular with the leg in full extension. If the extension gap is not balanced, adjust the angle of either the tibial or the femoral cut, or perform appropriate soft-tissue releases to achieve balance. If desired, perform a gentle varus/valgus stress test with the Flexion/Extension Spacer in place. Typically 1 mm to 3 mm of opening both medially and laterally is desirable.

If desired, the two-piece Alignment Rod can be inserted into the Extension/Flexion Spacer to assess alignment (34).

ATTENTION: At this stage it is only possible to check the extension gap.

Instruments



Alignment Rods:
445-113/10 short,
445-113/20 long



881-010/02
Extension/Flexion Spacer Block
10-12 mm



881-019/01
Shim, Spacer, H = 1 mm



881-019/04
Shim, Spacer, H = 4 mm

Femoral Sizing and Rotation

Femoral Sizing Guide

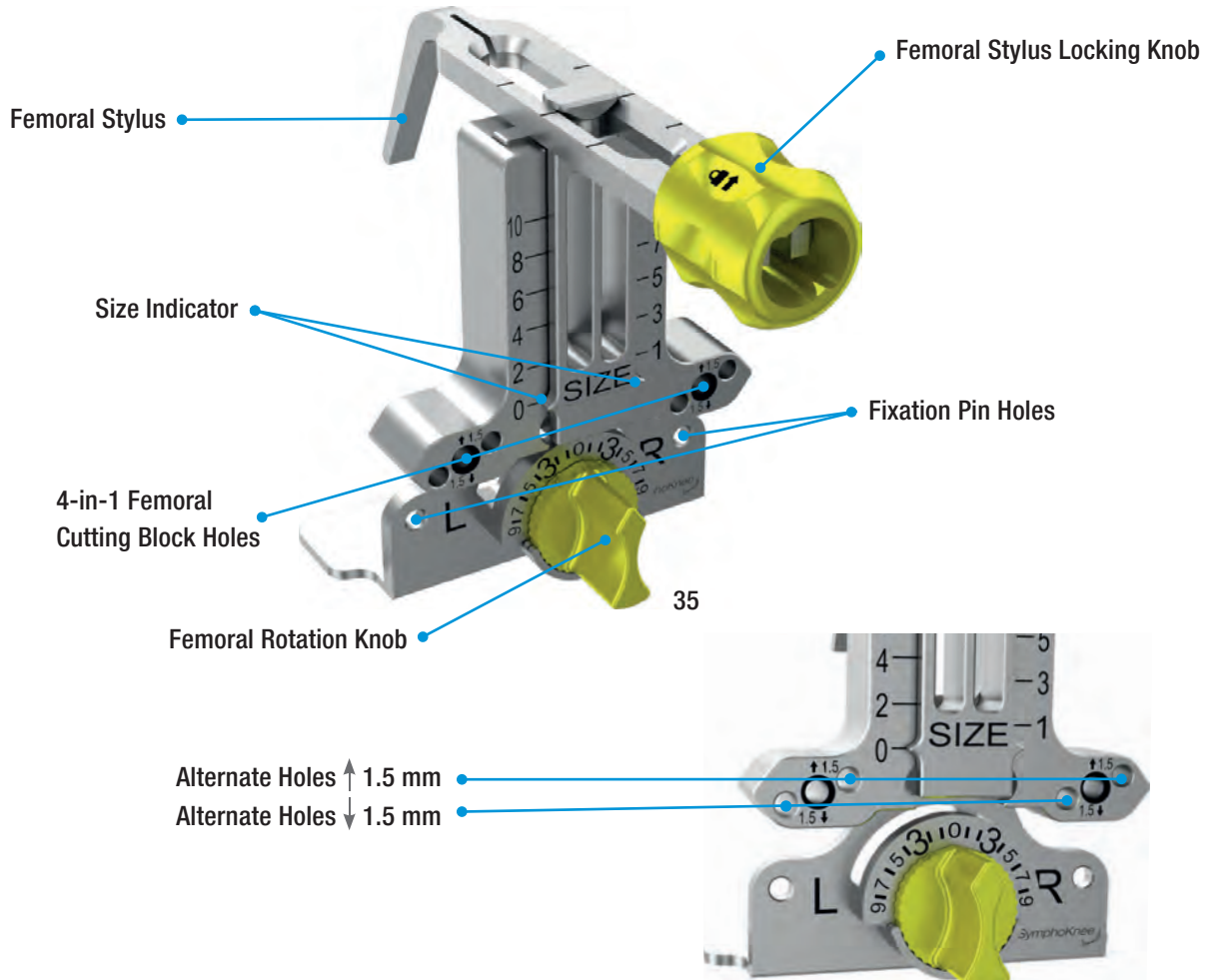

ATTENTION: The *LinkSymphoKnee* Femoral Sizing Guide is posterior referencing only.

The femoral rotation can be set from 0° to 9° by rotating the Femoral Rotation Knob towards the "L" half circle or the "R" half circle, for a left knee or a right knee respectively (35).

The *LinkSymphoKnee* Femoral Sizer allows to assess the final femoral A/P size and it features 11 Femoral Size Markings: Sizes 0-10.

ATTENTION: The *LinkSymphoKnee* Femoral Sizer is used for a Measured Resection surgical philosophy and is not a measurement device.

Instruments



881-100/00
Femoral Sizing Guide

Position the Femoral Sizing Guide so that the flat surface of the instrument is flush against the resected distal femur and the posterior paddles are flush against the posterior condyles (36).

Adjust the degree of external rotation to be parallel to the epicondylar axis and perpendicular to Whiteside's line by rotating the Femoral Rotation Knob, while holding the feet of the device against the posterior condyles (37).



36

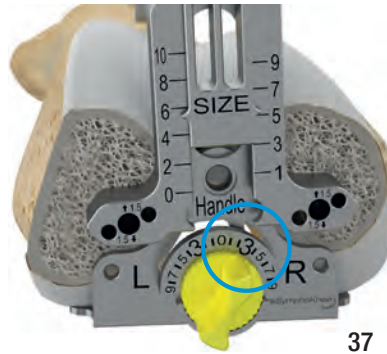

37



37b

OPTIONAL: To assess the femoral rotation compared to the tibial axes, attach the Quick Connect Handle to the Femoral Sizing Guide. The alignment can be checked by ensuring that the Alignment Rod remains parallel with the tibial axis (37b).

Place the Femoral Stylus on the anterior femur with the tip referencing the desired exit point of the Sawblade for the anterior cut. This is usually half way up the lateral, anterior prominence of the femoral trochlea (36).



38

Read the A/P femoral size shown by the Size Indicator directly on the scale marked on the body of the Femoral Sizer (38).

ATTENTION: Close the Femoral Stylus Locking Knob before reading the A/P femoral size (36).

OPTIONAL: To reproduce the known deficiency of the bone, a Femoral Posterior Shim can be used (2 mm, 3 mm or 4 mm thick) (38a). Select the Posterior Shim thickness that represents the thickness of the missing bone on the hypoplastic condyle. Place the Posterior Shim on the paddle of the Femoral Sizing Guide. A magnet will hold the construct in place (38b).



38a

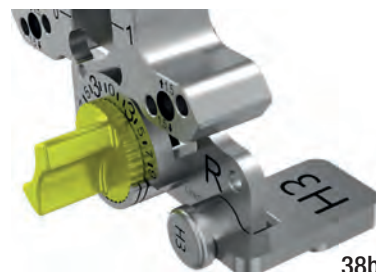

38b

Instruments



881-100/00
Femoral Sizing Guide



445-113/20
Alignment Rod, long



445-112/00
Handle, quick connect



881-109/03
Shim, Femoral Sizing Guide,
H = 3 mm

Once femoral rotation is set and size confirmation is complete, drill the holes for the 4-in-1 Femoral Cutting Block using the 3-mm Twist Drill through the 4-in-1 Femoral Cutting Block holes on the body of the Femoral Sizing Guide (39 & 40).

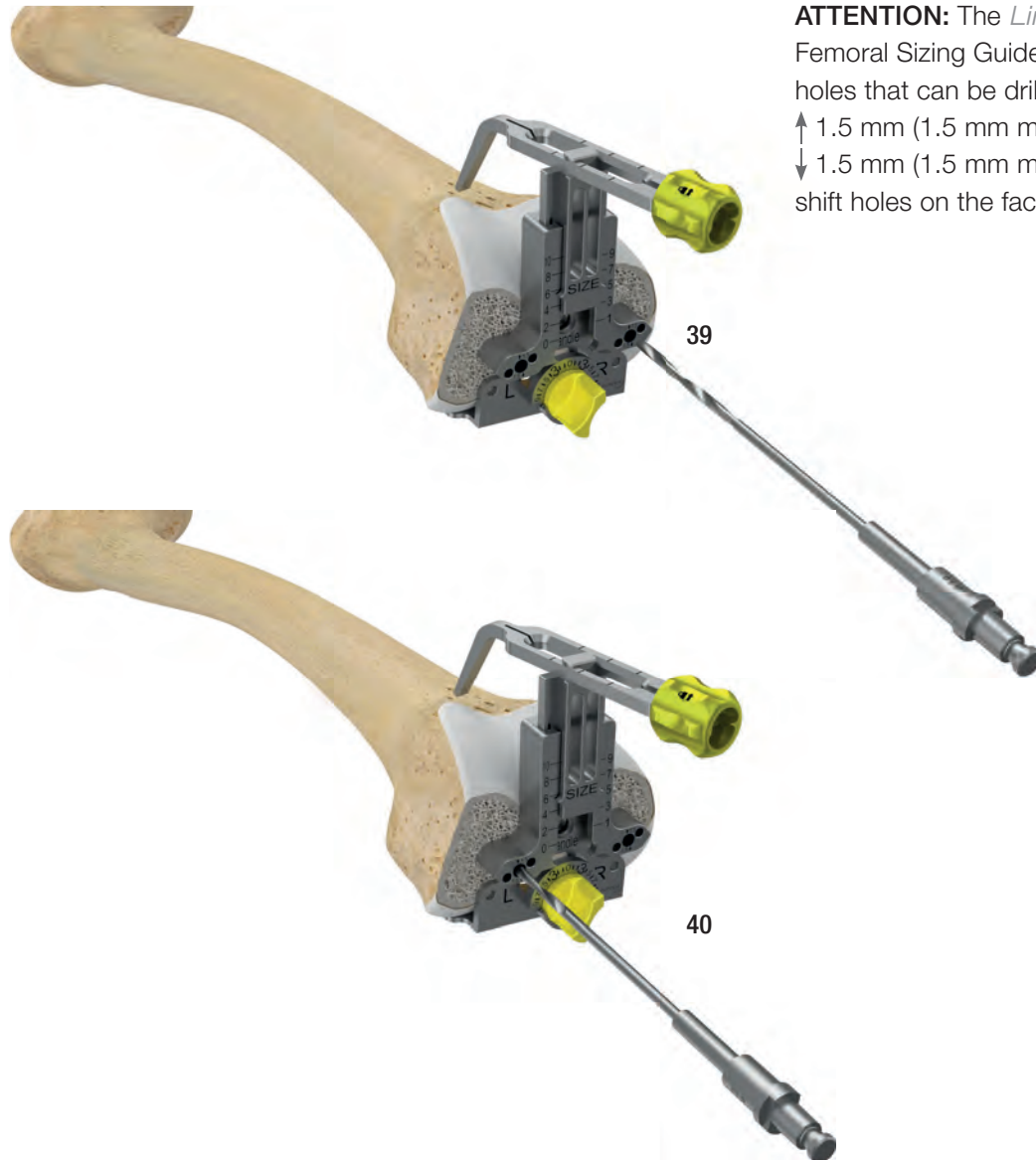

ATTENTION: The *LinkSymphoKnee* Femoral Sizing Guide features alternate holes that can be drilled through the
 ↑ 1.5 mm (1.5 mm more anterior holes) or
 ↓ 1.5 mm (1.5 mm more posterior holes)
 shift holes on the face of the Sizing Guide.

ATTENTION: The final M/L position of the Femoral Component is not determined during this step, but is addressed later in the surgical technique. This step just sets the M/L position of the 4-in-1 Cutting Block.

Remove the Femoral Sizing Guide.

Instruments



881-100/00
Femoral Sizing Guide



15-2040/02B
Twist Drill, Ø 3 mm

Femoral 4-in-1 Resection

Select the 4-in-1 Femoral Cutting Block that matches the femoral A/P size previously determined.

ATTENTION: The *LinkSymphoKnee* Instrument Set features eleven 4-in-1 Femoral Cutting Blocks, one for each A/P femoral size.

The *LinkSymphoKnee* 4-in-1 Femoral Cutting Block mimics precisely the M/L size of the standard final femoral components (0-10).

The M/L size of the wide femoral components (3+, 4+, 5+) can be assessed later in the surgical technique.

Open the Impactor/Extractor Handle lever and insert it into the 4-in-1 Femoral Cutting Block (41). Secure the Impactor/Extractor Handle to the 4-in-1 Femoral Cutting Block by closing the lever.

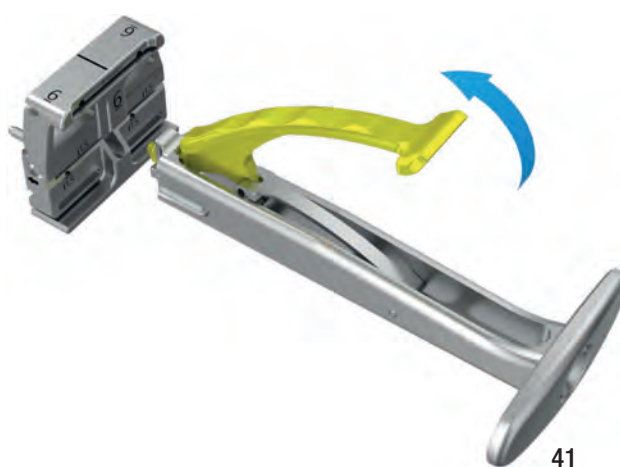

Place the 4-in-1 Femoral Cutting Block on the femur by aligning the 2 pegs on the back of the block with the previously drilled positioning holes (42).



Impact the 4-in-1 Femoral Cutting Block until it is flush with the femur (43).

Detach the Impactor/Extractor Handle, leaving the 4-in-1 Femoral Cutting Block flush on the distal femur.

Instruments



881-119/60
4-in-1 Femoral Cutting Block,
size 6



445-207/00
Impactor/Extractor Handle

OPTIONAL: Insert the Cutting Template (44) or a pin (45) through the lateral side of the anterior slot of the 4-in-1 Femoral Cutting Block to verify the correct anterior resection before cutting the femur and to ensure that notching is unlikely to occur.



OPTIONAL (only for Distal Cut First and Tibia First techniques): The flexion gap can be checked by using the Flexion Spacer in combination with the 4-in-1 Femoral Cutting Block. The Flexion Spacer is placed between the 4-in-1 Femoral Cutting Block (with its stepped side pushed as far as possible under the unresected femoral condyles) and the resected tibia (46).

ATTENTION: Use the the Flexion Spacer for Micro-Sizes with femoral sizes 0, 1 and 2.

ATTENTION: The Flexion Spacer is designed to assess the flexion gap in combination with the 4-in-1 Femoral Cutting Block only.



The Flexion Spacer can be connected to a 1 mm, 4 mm or 8 mm Shim to allow evaluation of multiple thicknesses:

- 10 mm + 1 mm Shim = 11 mm
- 10 mm + 4 mm Shim = 14 mm
- 12 mm + 4 mm Shim = 16 mm
- 10 mm + 8 mm Shim = 18 mm

Instruments



881-119/60
4-in-1 Femoral Cutting Block,
size 6



317-802/53
Cutting Template



445-124/65
Drill Pin



881-011/02
Flexion Spacer 4-in-1 Cut

Repositioning of the 4-in-1 Femoral Cutting Block

If the flexion gap is not equivalent to the extension gap or if there is a risk of unacceptable notching, it is possible to change the size of the 4-in-1 Femoral Cutting Block. This will alter the anterior femoral resection while keeping the same positioning holes (47).

ATTENTION: At this stage changing the size of the 4-in-1 Femoral Cutting Block will only affect the anterior cut (Posterior Referencing).

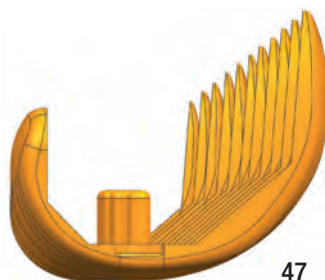

47

Alternate holes can then be drilled through the \uparrow 1.5 mm or \downarrow 1.5 mm shift holes on the face of the 4-in-1 Femoral Cutting Block (48). The 4-in-1 Femoral Cutting Block then needs to be removed and placed on the distal femur in the anteriorized or posteriorized holes. This will result in a 1.5 mm anterior or posterior shift of the 4-in-1 femoral resections (1.5 mm in A/P is equal to half size difference). Use the Cutting Template to verify that the desired anterior and posterior resections will be attained.



48



49

ATTENTION: Use the Impactor/Extractor Handle or the Slaphammer to axially remove the 4-in-1 Femoral Cutting Block (49).

OPTIONAL: Use the A/P Femoral Shift Block to move the 4-in-1 Femoral Cutting Block more than 1.5 mm. Place the A/P Femoral Shift Block on the distal femur in the holes for the 4-in-1 Femoral Cutting Block. Alternate holes can then be drilled through the +3 mm shift holes on the face of A/P Femoral Shift Block (49b). Remove the A/P Femoral Shift Block (3 mm in A/P is equal to 1 size difference).

The 4-in-1 Femoral Cutting Block then needs to be placed on the distal femur in the anteriorized holes. This will result in a 3 mm anterior shift of the 4-in-1 femoral resections. Turn the A/P Femoral Shift Block to drill the holes for a 3 mm posterior shift.



49b

Instruments



881-119/60
4-in-1 Femoral Cutting Block,
size 6



445-206/00
Slaphammer



881-019/03
A/P Femoral Shift Block +3 mm

Femoral 4-in-1 Resection

After final placement of the 4-in-1 Femoral Cutting Block, insert two Headed Drill Pins into the oblique pin holes on the medial and lateral aspects of the Cutting Block.

ATTENTION: The left and the right oblique pins point upwards in all 4-in-1 Femoral Cutting Blocks (50).



This pattern of fixation coupled with the pegs on the 4-in-1 Femoral Cutting Block should provide ample stability of the block (51).

Protecting the collateral ligaments, use a max. 1.27 mm thick oscillating sawblade to complete anterior, posterior, anterior chamfer and posterior chamfer resections (52 & 53).

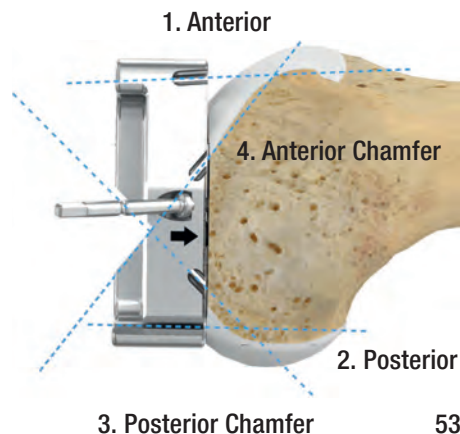

Upon completion of the cuts, remove all Pins and use the Impactor/Extractor Handle or the Slaphammer to axially remove the 4-in-1 Femoral Cutting Block (54).



Instruments



881-119/60
4-in-1 Femoral Cutting Block,
size 6



445-125/35
Headed Drill Pin



445-206/00
Slaphammer

Femoral Box Preparation

Fixed Bearing PS (Posterior Stabilized)

The Femoral PS Box Guide is selected according to the size of the femur and is positioned on the resected end of the femur. Alignment is performed on the notch and the M/L dimension (55).

The *LinkSymphoKnee* Instrument Set features fourteen Femoral PS Box Guides, one for each femoral size.

ATTENTION: The Femoral PS Box Guide is symmetrically designed to permit universal use. The M/L width of the Femoral PS Box Guide mimics the outer edges ("R Lat" Right Lateral and "L Lat" Left Lateral) of the final implant. Take care to position the guide to avoid overhang.

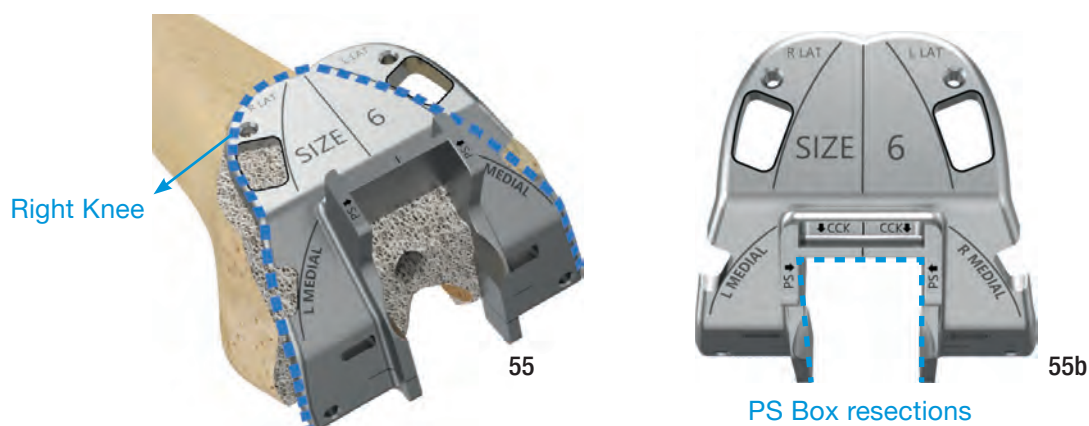

The Femoral PS Box Guide is fixed with at least two Headed Drill Pins (56). Using a narrow Saw Blade, saw the PS box (56b), taking care of not cutting through the CCK slot (CCK preparation only).



ATTENTION: When completing the notch cut, be careful to avoid excessive angulation of the Saw Blade or penetration past the posterior femoral cortex to avoid injury to the neurovascular structures. Avoid undercutting the condyles.

Instruments



881-113/60
Femoral PS Box Guide,
size 6



445-125/35
Headed Drill Pin

OPTIONAL: Open the Impactor/Extractor Handle lever and insert it into the Femoral PS Box Gauge. Secure the Impactor/Extractor Handle to the Femoral PS Box Gauge by closing the lever (57).



57



58

Impact the Femoral PS Box Gauge to compress bone (58).

ATTENTION: Use the the PS Box Gauge for Micro-Sizes with femoral sizes 0, 1 and 2.

Instruments



881-113/60
Femoral PS Box Guide,
size 6



445-125/35
Headed Drill Pin



445-207/00
Impactor/Extractor Handle



881-113/02
Femoral PS Box Gauge

Tibial Sizing

Attach the Quick Connect Handle to the appropriate Tibial Preparation Plate.

Place the Tibial Preparation Plate onto the resected tibial surface. Assess the tibial size to achieve maximal tibial coverage (59). Take care to put the Tibial Preparation Plate in the correct rotational alignment. To help alignment, insert the Alignment Rod into the Quick Connect Handle (60).



Secure the Tibial Preparation Plate by placing 2 or more Bone Nails in the dedicated holes of the Tibial Preparation Plate. Use the Universal Pin Inserter for driving and impacting the Bone Nails L = 25 mm or L = 35 mm (61).

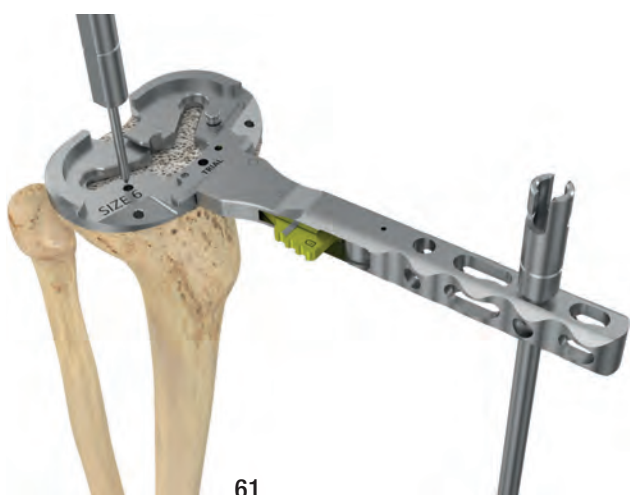

Instruments



881-283/60
Tibial Preparation Plate,
size 6



445-112/00
Handle, quick connect



445-113/10
Alignment Rod, short



445-128/35
Bone Nail



445-121/00
Universal Pin Inserter

Tibial Preparation

Attach the Tibial Reamer Guide to the Tibial Preparation Plate (62). Drill the hole for the central tibial stem using the appropriate Tapered Reamer, until it stops onto the Tibial Reamer Guide (63 & 64).

ATTENTION: The *LinkSymphoKnee* Instrument Set features three Tapered Reamers:

- One for the Monoblock Tibial Component (881-062/00)
- One for the Tibial Component with Taper Cap (881-062/99)

OPTIONAL: Attachment for the Quick Connect Handle



Attach the size-specific Tibial Keel Punch to the Impactor/Extractor Handle. Choose the appropriate Tibial Keel Punch according to the size of the Tibial Preparation Plate.

ATTENTION: The *LinkSymphoKnee* Instrument Set features five Tibial Keel Punches, each for two tibial sizes: 1-2, 3-4, 5-6, 7-8 and 9-10.

Open the Impactor/Extractor Handle lever and insert it in the Tibial Keel Punch (65). Secure the Impactor/Extractor Handle to the Tibial Keel Punch by closing the lever.



Instruments

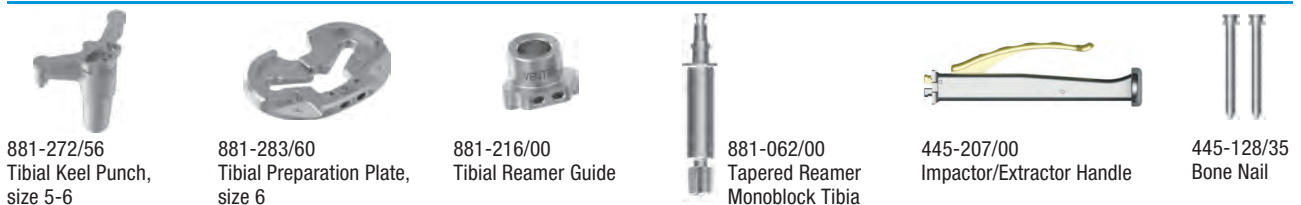

ATTENTION: Insert the Tibial Keel Punch into the Tibial Preparation Plate by hand until it reaches the level indicated by the frontal marking (66).

Carefully impact the Tibial Keel Punch into the Tibial Preparation Plate until it is fully seated onto the Tibial Preparation Plate.

After the Tibial Keel Punch is fully seated, remove the Impactor/Extractor Handle. The Tibial Keel Punch sits in the Tibial Preparation Plate and acts as the trial stem (67).



67

ATTENTION: Pre-drill the tibial peg holes with the Universal Drill if sclerotic bone is present (67a).



67a

Instruments



881-272/56
Tibial Keel Punch,
size 5-6



881-283/60
Tibial Preparation Plate,
size 6



881-012/00
Universal Drill



881-062/00
Tapered Reamer
Monoblock Tibia



445-207/00
Impactor/Extractor Handle



445-128/35
Bone Nail

Patella Preparation (Patella Resurfacing)

The following instructions describe how to use the *LinkSymphoKnee* Patella Component and they assume the use of the instrument set available for this procedure.

Sizing

A Patella Sizing Template corresponding to the implants is available (68). The size of implant is determined by placing the Sizing Template slightly medial and superior on the patella surface (69).



ATTENTION: The *LinkSymphoKnee* system includes 6 sizes of Patella Components. Each size features a different implant thickness and diameter. In the table below, all Patella Component dimensions are shown.

LinkSymphoKnee Patella Components – 3-peg

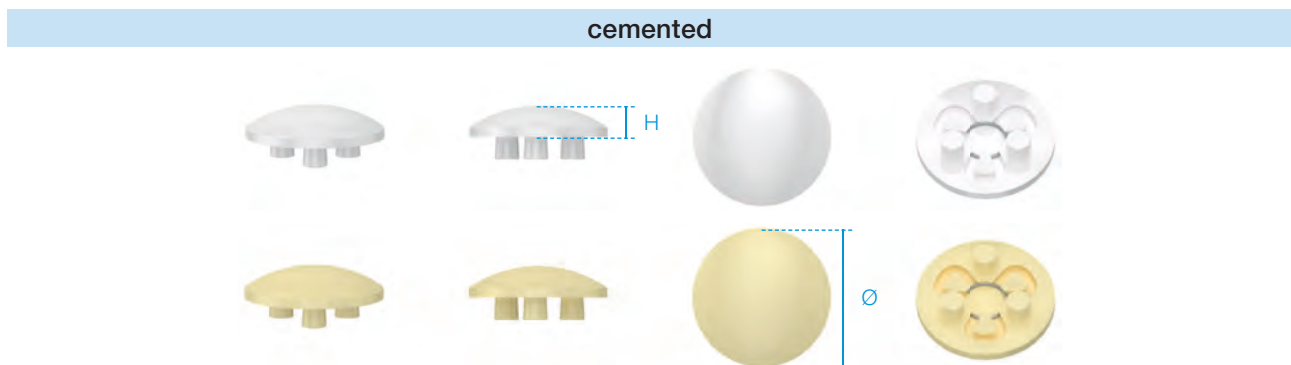

REF	REF	Ø	Height (H)
MAT UHMWPE	MAT E-Dur*	mm	mm
880-501/25	880-511/25 [#]	25	6
880-501/28	880-511/28 [#]	28	6
880-501/31	880-511/31 [#]	31	7
880-501/34	880-511/34 [#]	34	8
880-501/37	880-511/37 [#]	37	9
880-501/40	880-511/40 [#]	40	10

* E-Dur = Highly crosslinked UHMWPE (X-Linked PE) with Vit-E

[#] Upon request

Instruments



881-509/00
Patella Sizing Template



Patella Resection

Insert the Resection Guide (A) into the second groove from the top of the Patella Clamp Handle (B) (70). Now, insert the Depth Gauge (C) into the first groove from the top of the Patella Clamp Handle (B) (71).

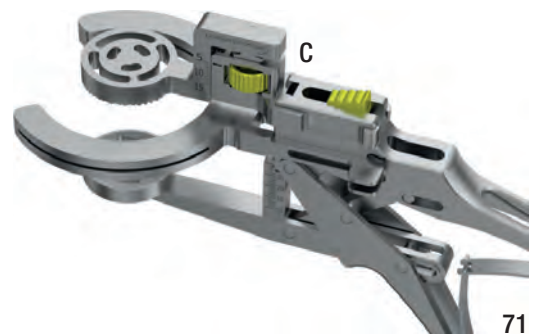

Set the appropriate resection level corresponding to the size of the patella component previously determined (72).



Position the Patella Clamp so that the sectional plane lies parallel to the extended patellar tendon. The Depth Gauge must lie on the bone. While pressing the hand grips, the Patella Clamp firmly fixes the patella by means of the integrated ratchet (73). If necessary, release the ratchet by pressing the trigger on the Patella Clamp Handle.

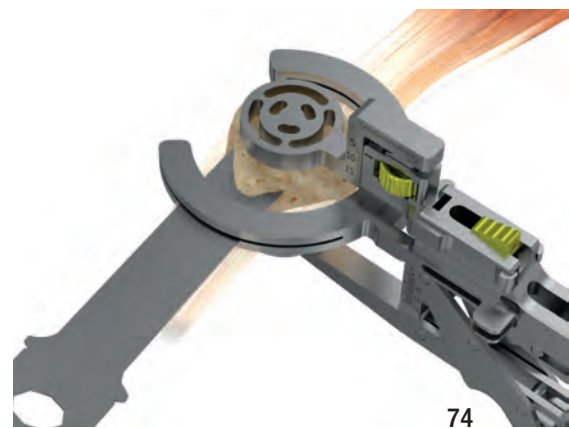

ATTENTION: It is important to ensure that the remaining patella is sufficiently thick (min. 12 mm).

The resection is carried out using an oscillating saw with a max. 1.27 mm thick Sawblade. The saw is guided using the saw slots of the Resection Guide (74).

Instruments



Drilling the Anchoring Holes

Insert the Drill Guide (E) for the anchoring holes into the first slot from the top of the Patella Clamp Handle (B) (75).

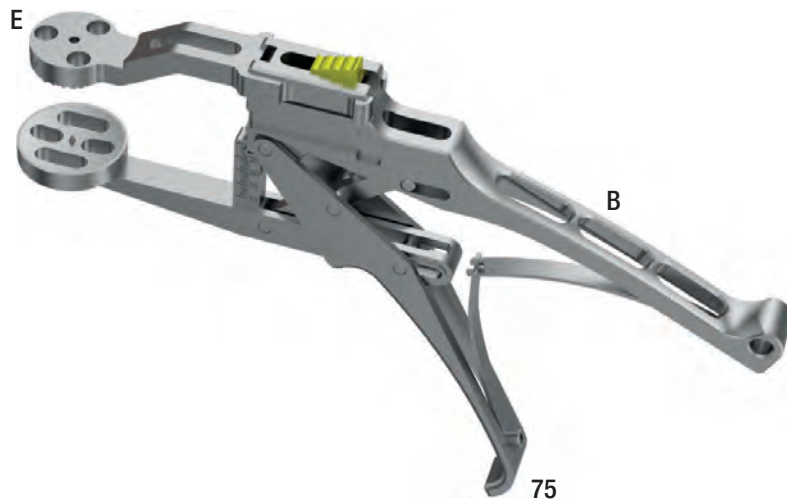

Position the Patella Clamp onto the previously resected patella surface and use the Universal Drill (H) for the anchoring holes. To prepare the seat for the anchoring holes, push the Universal Drill until stop (76). A Patella Trial can now be used (76a).

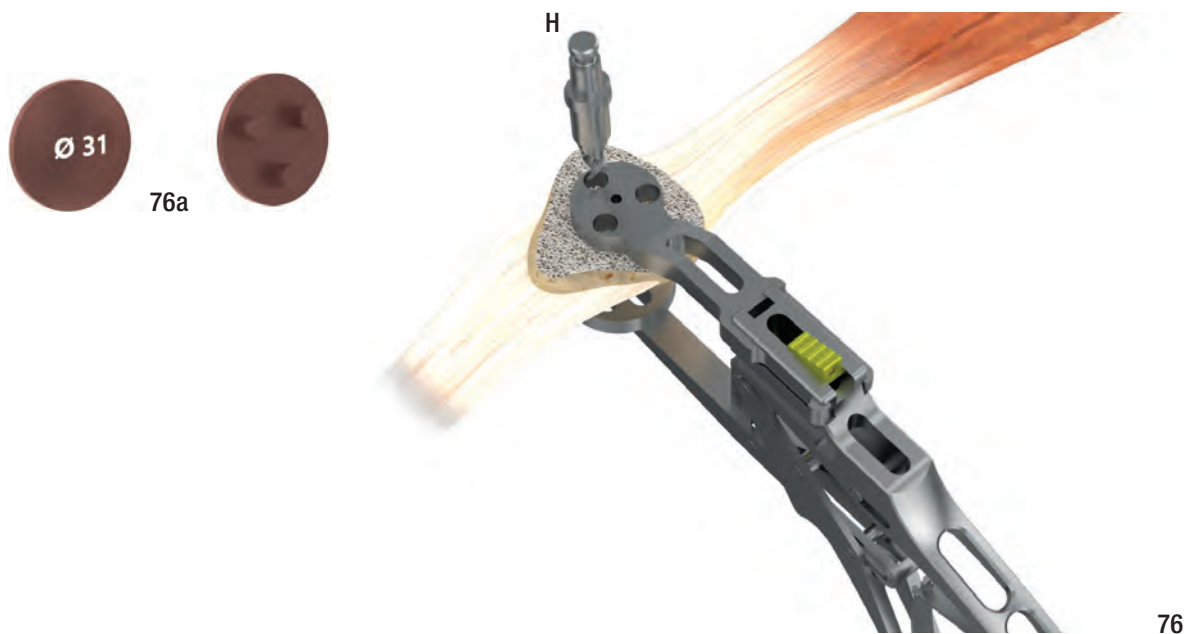

Instruments



445-902/00
Patella Clamp,
Handle



881-012/00
Universal Drill



881-511/31
Patella Clamp,
Drill Guide size 31



881-501/31
Patella Trial,
Ø 31 mm

Trial Reduction and Functional Test

The Femoral Trial (CR or PS) is selected according to the resected femoral size and is positioned using the Femoral Inserter/Extractor (77).

The *LinkSymphoKnee* Instrument Set features a specific femoral trial component for each femoral size and for each configuration.

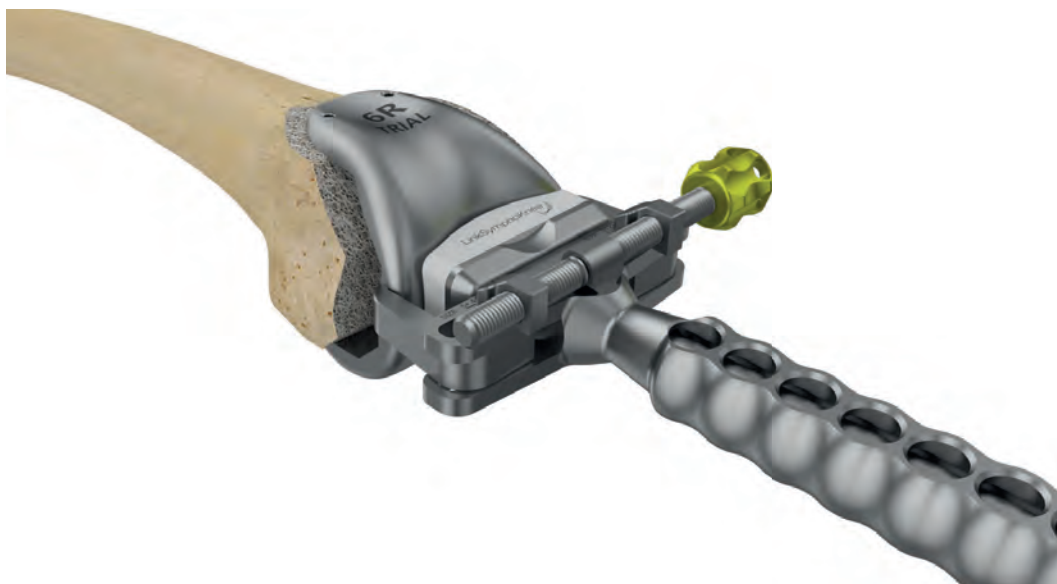

77



Femoral Trial CR



Femoral Trial PS

Instruments



881-041/00
Femoral Inserter/Extractor



881-120/60
Femoral Trial CR, right,
size 6



881-130/60
Femoral Trial PS, right,
size 6

Attach the Impactor/Extractor Handle to the Femoral Impactor Tip (**78a**).

Use the assembly to fully seat the Femoral Trial Component (**78**).

For CR Femur only, the lug holes are drilled using the Universal Drill (**79**).

The remaining posterior condyles and osteophytes can be removed using the curved Femoral Chisel (**80**).



78a



78



79



80

Instruments



881-041/99
Femoral Impactor Tip



445-207/00
Impactor/Extractor Handle



881-012/00
Universal Drill



881-120/60
Femoral Trial CR,
right, size 6



881-130/60
Femoral Trial PS,
right, size 6



445-208/00
Femoral Chisel

The Trial Plateau is selected and used according to which type of prosthesis is chosen – Fixed Bearing CR, Fixed Bearing PS or PS+ (81).



Select the appropriate thickness of the Trial Plateau:

10 mm, 11 mm, 12 mm or 14 mm.

ATTENTION: For adjusting the height of the Trial Plateau beyond 14 mm, use the +4 mm Shim in combination with the 12 mm Trial Plateau to reach 16 mm total thickness, or in combination with the 14 mm Trial Plateau to reach 18 mm total thickness.

Select the appropriate size of the Trial Plateau. The following table shows the possible *LinkSymphoKnee* size combinations:

CR Femoral Component

	0	1	2	3/3+	4/4+	5/5+	6	7	8	9	10	
Tibial Component	1	CR Articulating Surface 1-2					x	x	x	x	x	x
	2						x	x	x	x	x	x
	3	x	CR Articulating Surface 3-4						x	x	x	x
	4	x							x	x	x	x
	5	x	x	x	CR Articulating Surface 5-6						x	x
	6	x	x	x							x	x
	7	x	x	x	x	x	CR Articulating Surface 7-8					
	8	x	x	x	x	x						
	9	x	x	x	x	x	x	x	CR Articulating Surface 9-10			
	10	x	x	x	x	x	x	x				

Symbol Description: x = Combination not permitted

PS Femoral Component

	0	1	2	3/3+	4/4+	5/5+	6	7	8	9	10	
Tibial Component	1	PS/PS+ Articulating Surface 1-2			PS/PS+ Articulating Surface 1-2up		x	x	x	x	x	x
	2						x	x	x	x	x	x
	3	x	PS/PS+ Articulating Surface 3-4down		PS/PS+ Articulating Surface 3-4			x	x	x	x	
	4	x						x	x	x	x	
	5	x	x	x	PS/PS+ Articulating Surface 5-6						x	x
	6	x	x	x							x	x
	7	x	x	x	x	x	PS/PS+ Articulating Surface 7-8					
	8	x	x	x	x	x						
	9	x	x	x	x	x	x	x	PS/PS+ Articulating Surface 9-10			
	10	x	x	x	x	x	x	x				

Symbol Description: x = Combination not permitted

Instruments



881-130/60
Femoral Trial PS,
right, size 6

881-283/60
Tibial Preparation
Plate, size 6

881-225/10
Trial Plateau CR,
size 5-6, H = 10 mm

881-235/10
Trial Plateau PS,
size 5-6, H = 10 mm

881-245/10
Trial Plateau PS+,
Size 5-6, H = 10 mm

881-220/45
Shim Trial Plateau,
H = +4, size 5-6

445-128/35
Bone Nail

Attach the Quick Connect Handle to the selected Trial Plateau and drive it onto the Tibial Preparation Plate (82). Trial reduction is performed with the knee joint in extension and flexion, and the ligament tension is checked (83).



Make sure that no bony structures (e.g. osteophytes) or local soft tissue interfere with the range of motion. All trial components are then removed.

Instruments



881-130/60
Femoral Trial PS,
right, size 6



881-283/60
Tibial Preparation
Plate, size 6



881-235/10
Trial Plateau PS,
size 5-6, H = 10 mm



445-128/35
Bone Nail



445-112/00
Handle, quick connect

Final Implantation – Modular Tibia Base

Taper Cap or Stem Extension Assembly

When using a modular tibial component with Taper Cap or with Stem Extension, ensure that the tibia is prepared accordingly.

ATTENTION: Carefully remove the Safety Cap from the taper. The Safety Cap protects the Cone Adapter during transportation (84a).

ATTENTION: The Cone Adapter is pre-assembled to the Tibial implant.

ATTENTION: If the Cone Adapter is not assembled or is loose, use the Screwdriver for the Cone Adapter to tighten it to the femoral and tibial component (84b).

ATTENTION: The Taper Cap or the Stem Extension is fixed primarily by a morse taper connection and firmly secured by one Security Screw.

Overturn the modular Tibial Component. Slide the chosen Taper Cap or Stem Extension onto the male morse taper of the Tibial Component (84c).

Ensure the coupling of the Taper Cap or Stem Extension with the Tibial Component by impacting with a hammer.

ATTENTION: To avoid a metal on metal contact between the Taper Cap and the Hammer, use the Tibial/Femoral Coupling Base Tip.

Connect the Tibial/Femoral Coupling Base Tip with the Impactor/Extractor Handle (85a).

Slide the Tibial/Femoral Coupling Base Tip onto the top of the Taper Cap. Two Hammer blows are enough (85b).

Use the Torque Wrench (hex 2.5 mm) to tighten the Security Screw until it stops (86). Final Tibial Component assembly (87).

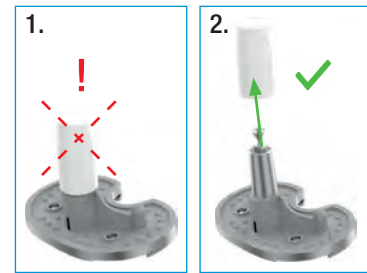

84a



84b



84c



85a

85b



86



87

Instruments



15-2545
Torque Wrench, hex 2.5 mm



445-207/00
Impactor/Extractor Handle



881-040/99
Tibial Femoral Coupling Base Tip



151-131/00
Screwdriver for Cone Adapter

Fixed Bearing

The implantation sequence for *LinkSymphoKnee* Fixed Bearing CR (Cruciate Retaining) and Fixed Bearing PS (Posterior Stabilized) is described below:

- 1 Fixed Bearing Tibial Component implantation
- 2 Femoral Component implantation
- 3 Fixed Bearing PE Articulating Surface implantation

1 Fixed Bearing Tibial Component Implantation

Prepare the sclerotic bone to ensure a continuous cement mantle with good cement interdigitation of 2 mm - 4 mm. This can be done by drilling holes and cleansing the bone with Pulsatile Lavage.

The bone cement is prepared following the specific manufacturer's instructions.

Apply a layer of bone cement to the underside of the Tibial Component, to the bone, or both.

Attach the Tibial Inserter to the Fixed Bearing Tibial Component (87a).

Carefully insert the Fixed Bearing Tibial Component, avoiding malrotation, and impact into place (87b).

If needed, the Tibial Impactor Tip, assembled with the Impactor/Extractor Handle (87c), can be used to complete the seating of the component (87d).

Complete implantation with several hammer blows to the top of assembly. Then use a Curette to remove all extruded cement.

ATTENTION: Ensure that excess bone cement is completely removed and no loose bone cement particles remain, especially in the posterior part of the joint.

ATTENTION: The cementless Tibial Component is inserted and impacted directly into the resected tibial bone without applying bone cement.



Instruments



881-042/00
Tibial Inserter



445-207/00
Impactor/Extractor Handle



881-042/99
Tibial Impactor Tip

2 Femoral Component Implantation

The bone cement is prepared following the specific manufacturer's instructions.

Apply a layer of bone cement to the backside of the Femoral Component, to the bone, or both.

Place the selected Femoral Component onto the bone by hand or, if preferred, use the Femoral Inserter/Extractor.

Deliver several hammer blows to the Femoral Inserter/Extractor (**88**).



88

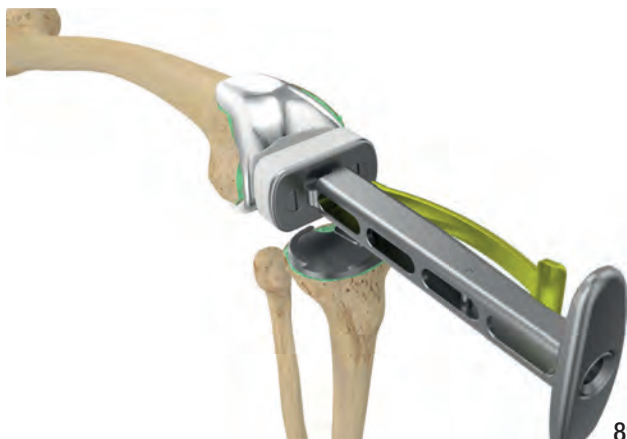

89

Release the Femoral Inserter/Extractor and use the Femoral Impactor Tip (assembled to the Impactor/Extractor Handle) to complete the component impaction (**89**). Then use a Curette to remove all extruded cement.

ATTENTION: Ensure that excess bone cement is completely removed and no loose bone cement particles remain, especially in the posterior part of the joint.

ATTENTION: The cementless Femoral Component is inserted and impacted directly into the resected femoral bone without applying bone cement.

Instruments



881-041/00
Femoral Inserter/Extractor



445-207/00
Impactor/Extractor Handle



881-041/99
Femoral Impactor Tip

3 Fixed Bearing PE Articulating Surface

OPTIONAL: A trial reduction may be performed using Trial Plateaus (90).

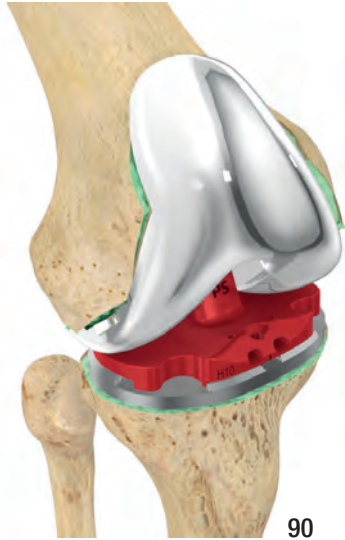

The Fixed Bearing PE Articulating Surface (Fixed Bearing CR or Fixed Bearing PS or fixed Bearing PS+) is selected.

Select the appropriate size of the Fixed Bearing PE Articulating Surface. The following table shows the possible *LinkSymphoKnee* size combinations:

CR Femoral Component

	0	1	2	3/3+	4/4+	5/5+	6	7	8	9	10	
Tibial Component	1	CR Articulating Surface 1-2					x	x	x	x	x	x
	2	CR Articulating Surface 1-2					x	x	x	x	x	x
	3	x	CR Articulating Surface 3-4						x	x	x	x
	4	x	CR Articulating Surface 3-4						x	x	x	x
	5	x	x	x	CR Articulating Surface 5-6				x	x	x	
	6	x	x	x	CR Articulating Surface 5-6				x	x	x	
	7	x	x	x	x	x	CR Articulating Surface 7-8					
	8	x	x	x	x	x	CR Articulating Surface 7-8					
	9	x	x	x	x	x	x	x	CR Articulating Surface 9-10			
	10	x	x	x	x	x	x	x	CR Articulating Surface 9-10			

Symbol Description: x = Combination not permitted

PS Femoral Component

	0	1	2	3/3+	4/4+	5/5+	6	7	8	9	10	
Tibial Component	1	PS/PS+ Articulating Surface 1-2			PS/PS+ Articulating Surface 1-2up		x	x	x	x	x	x
	2	PS/PS+ Articulating Surface 1-2			PS/PS+ Articulating Surface 1-2up		x	x	x	x	x	x
	3	x	PS/PS+ Articulating Surface 3-4down		PS/PS+ Articulating Surface 3-4			x	x	x	x	
	4	x	PS/PS+ Articulating Surface 3-4down		PS/PS+ Articulating Surface 3-4			x	x	x	x	
	5	x	x	x	PS/PS+ Articulating Surface 5-6				x	x	x	
	6	x	x	x	PS/PS+ Articulating Surface 5-6				x	x	x	
	7	x	x	x	x	x	PS/PS+ Articulating Surface 7-8					
	8	x	x	x	x	x	PS/PS+ Articulating Surface 7-8					
	9	x	x	x	x	x	x	x	PS/PS+ Articulating Surface 9-10			
	10	x	x	x	x	x	x	x	PS/PS+ Articulating Surface 9-10			

Symbol Description: x = Combination not permitted

Instruments



881-235/10
Trial Plateau PS,
size 5-6, H = 10 mm

Select the appropriate thickness of the Fixed Bearing PE Articulating Surface.

Ensure that the Fixed Bearing PE Articulating Surface is pushed as far posteriorly as it will go before impaction (**90a**). The PE posterior lip must rest beneath the posterior dovetail of the Tibial Component.

Impact anteriorly the Fixed Bearing PE Articulating Surface to snap it in place using the Articulating Surface Impactor (**90b**). Remove all excess bone cement.

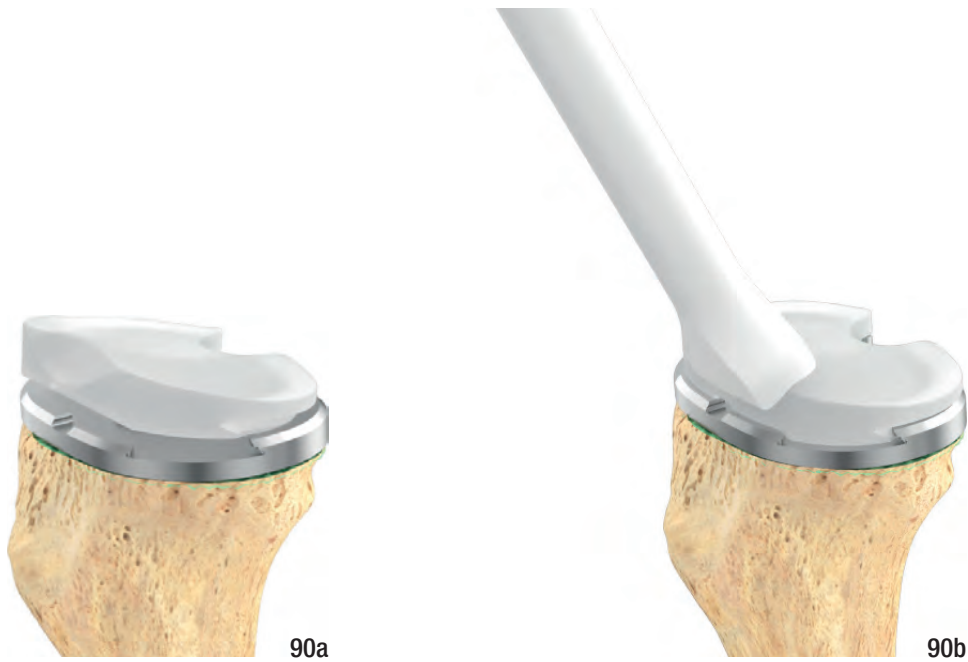

Instruments



881-040/01
Articulating Surface Impactor

Patella Implantation

Insert the Clamp Arm (F) into the first slot from the top of the Patella Clamp Handle (B) (91).

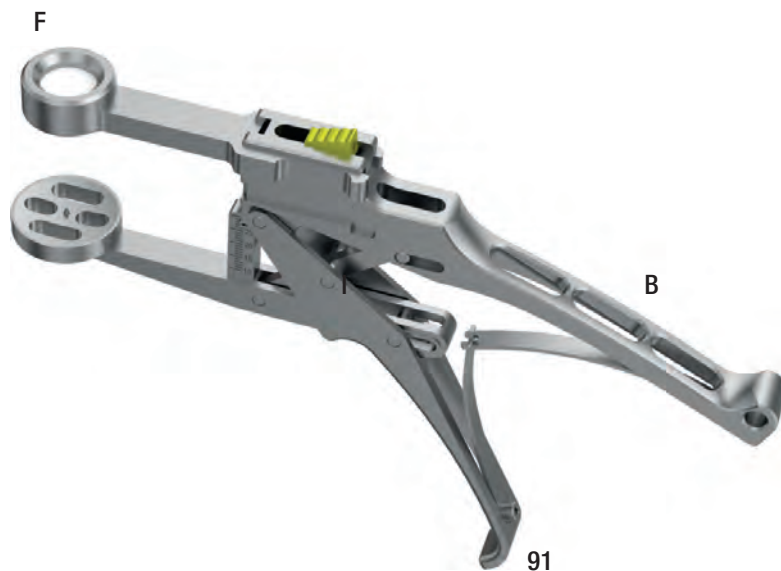

The bone cement is prepared following the specific manufacturer's instructions. Following extensive rinsing and removal of all impeding soft tissue, the bone cement is applied to the back of the implant, and the implant is placed by hand and pressed on using the Patella Clamp Handle with the Clamp Arm (92).

ATTENTION: Ensure that excess bone cement is completely removed and no loose bone cement particles remain in the joint.



Instruments



445-902/00
Patella Clamp,
Handle



445-904/00
Patella Clamp, Arm

Functional Test

Perform a final functional test through an entire range of motion to check that all components are properly positioned, and also to check for proper ligament tension and patella tracking (**93** & **94**).



LinkSymphoKnee Fixed Bearing CR
(Cruciate Retaining).



LinkSymphoKnee Fixed Bearing PS/PS+
(Posterior Stabilized/Posterior Stabilized+).

Appendix 1, IM Tibial Guide

Intramedullary Tibial Guide Assembly

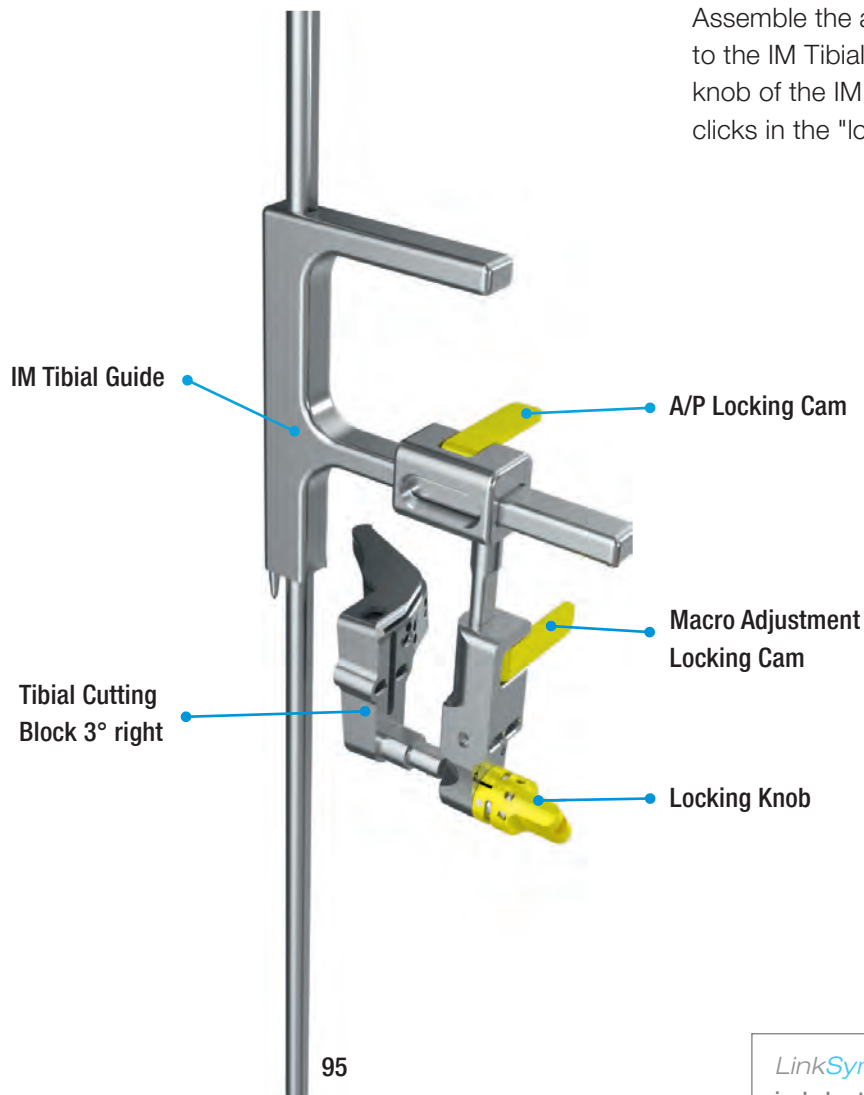

Assemble the appropriate Tibial Cutting Block to the IM Tibial Guide and lock it by twisting the knob of the IM Tibial Guide clockwise until it clicks in the "lock position" (95).

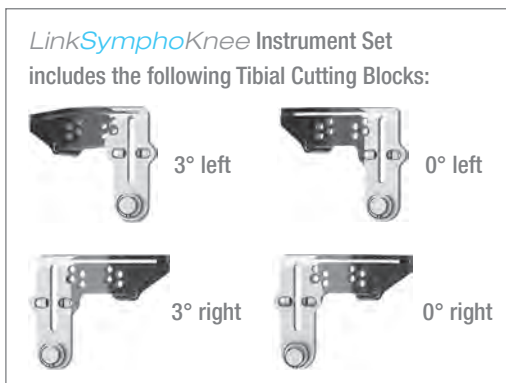

Instruments



Intramedullary Tibial Guide Alignment

Open the tibial canal using the Starting Reamer. Insert the IM Tibial Guide, assembled together with the Intramedullary Rod, into the tibia (96).

OPTIONAL: To assess tibial alignment, attach the Quick Connect Handle to the IM Tibial Guide, and insert the Alignment Rod. Rotation and alignment can be checked by ensuring that the Alignment Rod remains parallel with the tibial axis.



Impact the IM Tibial Guide onto the proximal tibia.

Instruments



Setting the Tibial Resection Level

Insert the foot of the Adjustable Stylus into the slot of the Tibial Cutting Block and adjust it to the appropriate level. Release the Locking Cam on the IM Tibial Guide, allowing for macro-adjusting the height of the Tibial Cutting Block (97).



97

The scale on the body of the Adjustable Stylus indicates the amount of bone and residual cartilage to be resected.

ATTENTION:

LinkSymphoKnee **Fixed Bearing CR** (Cruciate Retaining), **Fixed Bearing PS** (Posterior Stabilized), **Fixed Bearing PS+** (Posterior Stabilized +) and **All-Poly PS Tibial Component** feature 10 mm of minimal tibial component thickness (tibial baseplate + PE articulating surface).

Set the Adjustable Stylus according to the patient's anatomic situation, avoiding excessive tibial resection. Confirm tibial resection level using Cutting Template introduced as a free saw blade into the Cutting Block.

After the Tibial resection level has been set, close the Macro Adjustment Locking Cam and pin the Tibial Cutting Block through the anterior parallel "0" holes, using two Drill Pins.

Remove the IM Tibial Guide and resect the tibia. The resection level can be adjusted by using the distal or proximal pin holes, which move the block 2 mm more proximal, 2 mm more distal or 4 mm more distal. If desired, the Cutting Block can be more securely fixed with an additional Headed Drill Pin placed through one of the distal angled holes (98).



98

Instruments



Appendix 2, All-Poly Tibia PS

The All-Poly PS tibial component (99) can only be used with the PS Femoral Component.

The All-Poly PS tibial component preparation requires the same instruments as for the monoblock metal-backed tibial component. Select the appropriate size of the All-Poly PS Tibial Component. The following table shows the possible *LinkSymphoKnee* size combinations:

		PS Femoral Component										
		0	1	2	3/3+	4/4+	5/5+	6	7	8	9	10
All-Poly PS Tibial Component	1	✓	✓	✓								
	1up				✓							
	2	✓	✓	✓								
	2up				✓	✓						
	3down		✓	✓								
	3				✓	✓	✓					
	4down			✓								
	4				✓	✓	✓	✓				
	5				✓	✓	✓	✓	✓			
	6					✓	✓	✓	✓	✓		
	7						✓	✓	✓	✓	✓	
	8							✓	✓	✓	✓	✓
9								✓	✓	✓	✓	
10									✓	✓	✓	

Symbol Description: ✓ = Combination allowed



Size	All-Poly PS Trial Component Construct
1	Tibial Preparation Plate, size 1 + Trial Plateau PS, size 1-2
1up	Tibial Preparation Plate, size 1 + Trial Plateau PS, size 1-2up
2	Tibial Preparation Plate, size 2 + Trial Plateau PS, size 1-2
2up	Tibial Preparation Plate, size 2 + Trial Plateau PS, size 1-2up
3down	Tibial Preparation Plate, size 3 + Trial Plateau PS, size 3-4down
3	Tibial Preparation Plate, size 3 + Trial Plateau PS, size 3-4
4down	Tibial Preparation Plate, size 4 + Trial Plateau PS, size 3-4 down
4	Tibial Preparation Plate, size 4 + Trial Plateau PS, size 3-4
5	Tibial Preparation Plate, size 5 + Trial Plateau PS, size 5-6
6	Tibial Preparation Plate, size 6 + Trial Plateau PS, size 5-6
7	Tibial Preparation Plate, size 7 + Trial Plateau PS, size 7-8
8	Tibial Preparation Plate, size 8 + Trial Plateau PS, size 7-8
9	Tibial Preparation Plate, size 9 + Trial Plateau PS, size 9-10
10	Tibial Preparation Plate, size 10 + Trial Plateau PS, size 9-10

The All-Poly PS Tibial Components are available in 10, 12 and 14 mm height only. For the Trial use the following combinations:

- Tibial Preparation Plate + 10 mm Trial Plateau = 10 mm All-Poly Tibial Component
- Tibial Preparation Plate + 12 mm Trial Plateau = 12 mm All-Poly Tibial Component
- Tibial Preparation Plate + 14 mm Trial Plateau = 14 mm All-Poly Tibial Component

Prepare the sclerotic bone to ensure a continuous cement mantle with good cement interdigitation of 2-4 mm. This can be done by drilling holes and cleansing the bone with Pulsatile Lavage. The bone cement is prepared following the specific manufacturer's instructions. Apply a layer of bone cement to the underside of the All-Poly PS Tibial Component, to the bone, or both **(99b)**.



99b

Carefully insert by hand the All-Poly PS Tibial Component, avoiding malrotation. The All-Poly Tibial Impactor Tip (assembled with the Impactor/Extractor Handle) can be used to complete the seating of the component.

Complete implantation with several hammer blows to the top of Tibial Impactor. Then use a Curette to remove all extruded cement **(100)**.



100



101

ATTENTION: Ensure that excess bone cement is completely removed and no loose bone cement particles remain, especially in the posterior part of the joint **(101)**.

Instruments



445-207/00
Impactor/Extractor Handle



881-042/90
Tibial Impactor Tip All Poly

Appendix 3, CCK Femoral Preparation

The *LinkSymphoKnee* Instruments allow for a conversion from PS femoral preparation to a CCK femoral preparation in a few steps.

The Femoral PS Box Guide is selected according to the size of the femur and is positioned on the resected end of the femur. Alignment is performed on the notch and the M/L dimension.

The *LinkSymphoKnee* Instrument Set features fourteen Femoral PS Box Guides, one for each femoral size.

ATTENTION: The Femoral PS Box Guide is symmetrically designed to permit universal use. The M/L width of the Femoral PS Box Guide mimics the outer edges ("R Lat" Right Lateral and "L Lat" Left Lateral) of the final implant. Take care to position the guide to avoid overhang (102a).

Fix the Femoral PS Box Guide with at least two Headed Drill Pins.

Saw the femoral box with a narrow sawblade using the proximal slot marked with "CCK"(102). This resection allows preparation of the femoral box for the CCK femoral components.

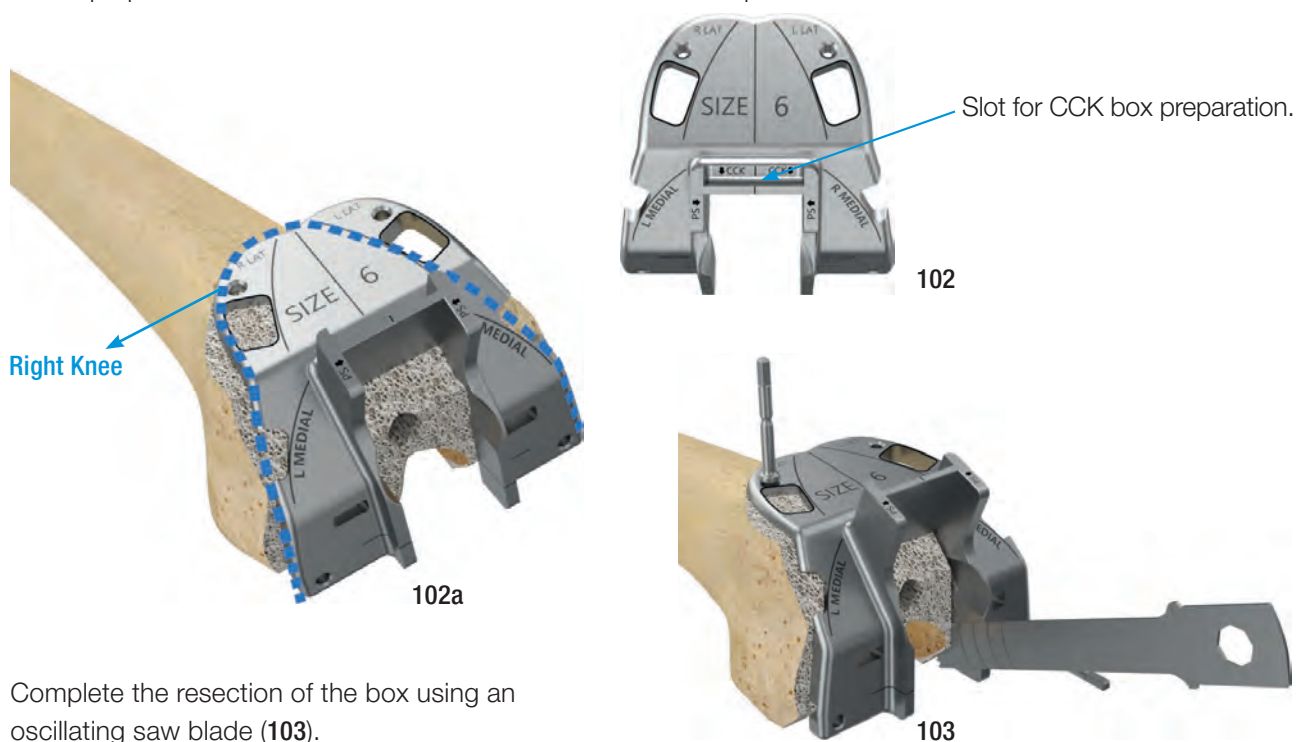

Complete the resection of the box using an oscillating saw blade (103).

ATTENTION: When completing the notch cut, be careful to avoid excessive angulation of the Saw Blade or penetration past the posterior femoral cortex to avoid injury to the neurovascular structures. Avoid undercutting the condyles.

Instruments



445-125/35
Headed Drill
Pin



881-113/60
Femoral PS Box Guide,
size 6

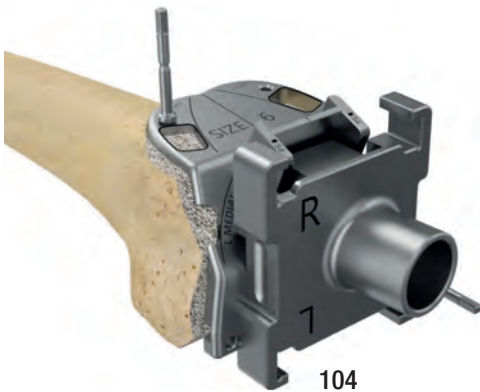

Attach the Reamer Guide for Femoral Box CCK to the Femoral PS Box Guide (104)

ATTENTION: The Reamer Guide for Femoral Box CCK is suitable for left and right knees. Ensure that the Reamer Guide for the Femoral Box CCK is assembled correctly according to the operated leg.

Ream until the stop, using the Tapered Reamer, CCK (105).

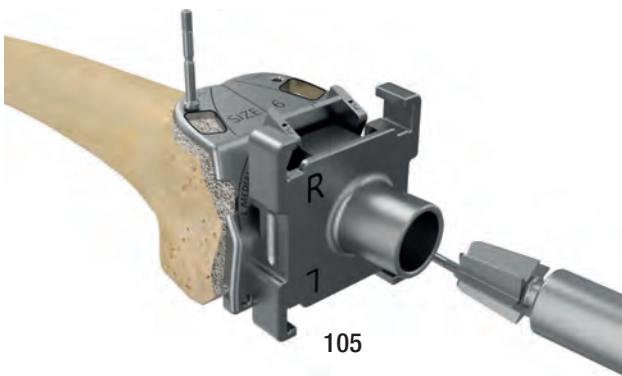

Assemble the 50 mm Conical stem trial (50 mm Trial Stem Conical Cemented (1) + Neutral Stem Adapter (2)) to the CCK Femoral Trial component selected according to the resected femoral size (106).

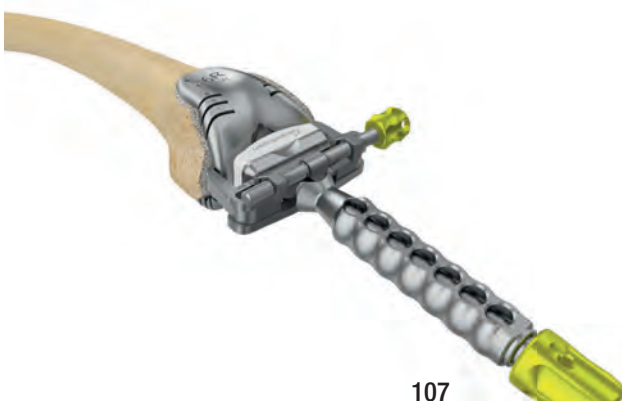
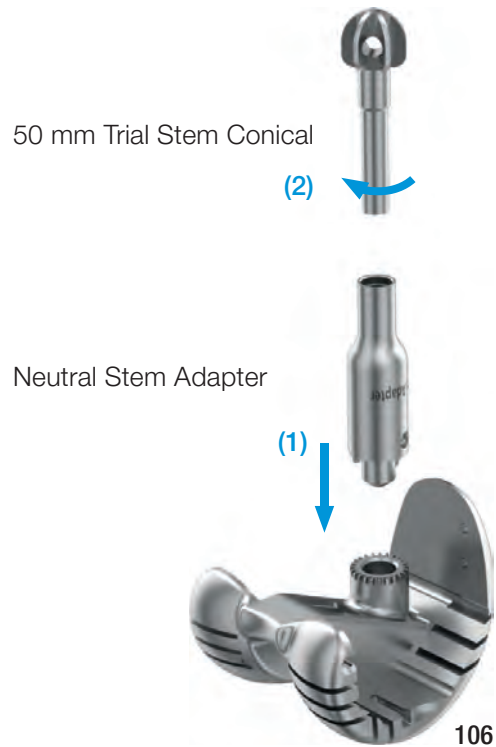

The Femoral Trial CCK assembly is positioned using the Femoral Inserter/Extractor (107).

Instruments



881-041/00
Femoral
Inserter/Extractor



881-150/60
Femoral Trial CCK,
right, size 6



151-501/00
Neutral Stem Adapter



881-067/17 Tapered
Reamer, CCK



881-113/60
Femoral PS Box Guide,
size 6



445-125/35
Headed Drill
Pin



881-116/00
Reamer Guide,
Femoral Box, CCK



151-050/16
50 mm Trial Stem
Conical Cemented

Release the Femoral Inserter/Extractor and use the Femoral Impactor Tip (assembled to the Impactor/Extractor Handle) to complete the trial component impaction (108).



108

The *LinkSymphoKnee* CCK Femoral Components can be combined with Fixed Bearing PS and PS+ Articulating Surfaces.

The following table shows the possible *LinkSymphoKnee* size combinations of the CCK Femoral Component with PS and PS+ Articulating Surfaces:

		CCK Femoral Component										
		0	1	2	3/3+	4/4+	5/5+	6	7	8	9	10
Tibial Component	1	PS/PS+ Articulating Surface 1-2			PS/PS+ Articulating Surface 1-2up		x	x	x	x	x	x
	2	PS/PS+ Articulating Surface 1-2			PS/PS+ Articulating Surface 1-2up		x	x	x	x	x	x
	3	x	PS/PS+ Articulating Surface 3-4down		PS/PS+ Articulating Surface 3-4				x	x	x	x
	4	x	PS/PS+ Articulating Surface 3-4down		PS/PS+ Articulating Surface 3-4				x	x	x	x
	5	x	x	x	PS/PS+ Articulating Surface 5-6						x	x
	6	x	x	x	PS/PS+ Articulating Surface 5-6						x	x
	7	x	x	x	x	x	PS/PS+ Articulating Surface 7-8					
	8	x	x	x	x	x	PS/PS+ Articulating Surface 7-8					
	9	x	x	x	x	x	x	x	PS/PS+ Articulating Surface 9-10			
	10	x	x	x	x	x	x	x	PS/PS+ Articulating Surface 9-10			

Symbol Description: x = Combination not permitted

ATTENTION: Refer to the *LinkSymphoKnee* CCK Surgical Technique for the CCK Articulating Surfaces compatibility chart.

Instruments



445-207/00
Impactor/Extractor Handle



881-150/60
Femoral Trial CCK,
right, size 6



151-050/16
50 mm Trial Stem
Conical Cemented



151-501/00
Neutral Stem Adapter



881-041/99
Femoral Impactor Tip

Extraction of Femoral Trial Component

OPTIONAL: In order to extract the Femoral Trial Components, it is possible to use the Slaphammer in combination with the Femoral Inserter/Extractor (109)

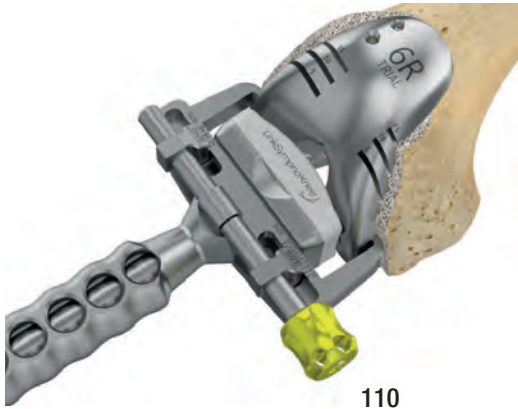





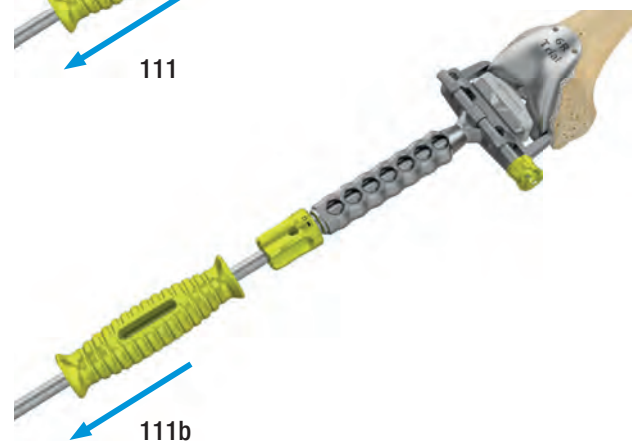
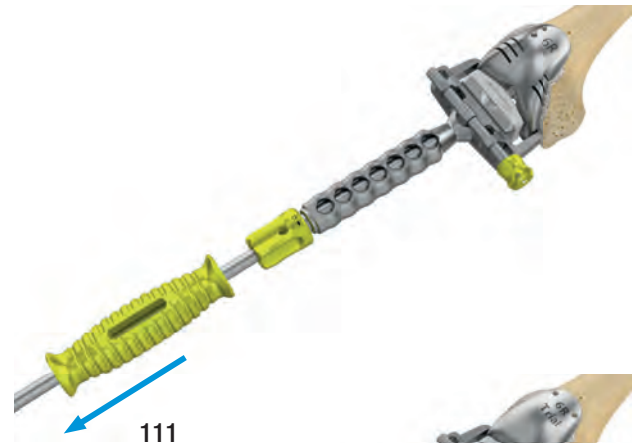

Assemble the Femoral Inserter/Extractor on the CCK Femoral Trial component (110).

Use the Femoral Inserter/Extractor and Slaphammer to remove the Femoral Trial (111).

ATTENTION: The same Femoral Inserter/Extractor and Slap Hammer can be used to remove the CR trial (111a) and the PS Trial components (111b).



Instruments

						
445-206/00 Slaphammer	881-041/00 Femoral Inserter/Extractor	881-150/60 Femoral Trial CCK, right, size 6	151-050/16 50 mm Trial Stem Conical Cemented	151-501/00 Neutral Stem Adapter	881-120/60 Femoral Trial CR, right, size 6	881-130/60 Femoral Trial PS, right, size 6

CCK Femoral Component with Modular Stem Assembly

Select the final stem, referencing to the ones used for the Trial Assembly.

ATTENTION: Carefully remove the Safety Cap from the taper. The Safety Cap protects the Cone Adapter during transportation (112).

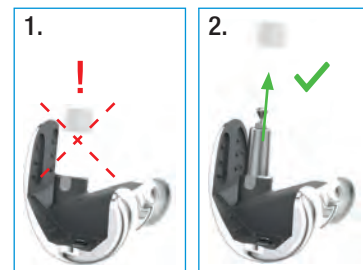

112

ATTENTION: The Cone Adapter is pre-assembled to the Femoral implant.

ATTENTION: If the Cone Adapter is not assembled or is loose, use the Screwdriver for the Cone Adapter to tighten it to the femoral component (113).

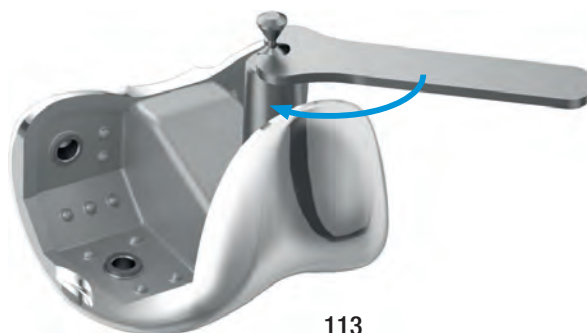

113

ATTENTION: To avoid a metal on metal contact between the Stem and the Hammer, use the Tibial/Femoral Coupling Base Tip.

Connect the Tibial/Femoral Coupling Base Tip with the Impactor/Extractor Handle (114).



114

Instruments



151-131/00
Screwdriver for Cone Adapter



445-207/00
Impactor/Extractor
Handle



881-040/99
Tibial Femoral Coupling Base Tip

Slide the Tibial/Femoral Coupling Base Tip onto the top of the Stem.
Two Hammer blows are enough (115).

Always use a Centralizer with cemented stems (116)



115



116

Secure the Security Screw for the Cone Adapter with the Torque Wrench (hex 2.5 mm) (117).

ATTENTION: The Security Screw is included in the package of the CCK Femoral Component and of the Modular Tibial Component.

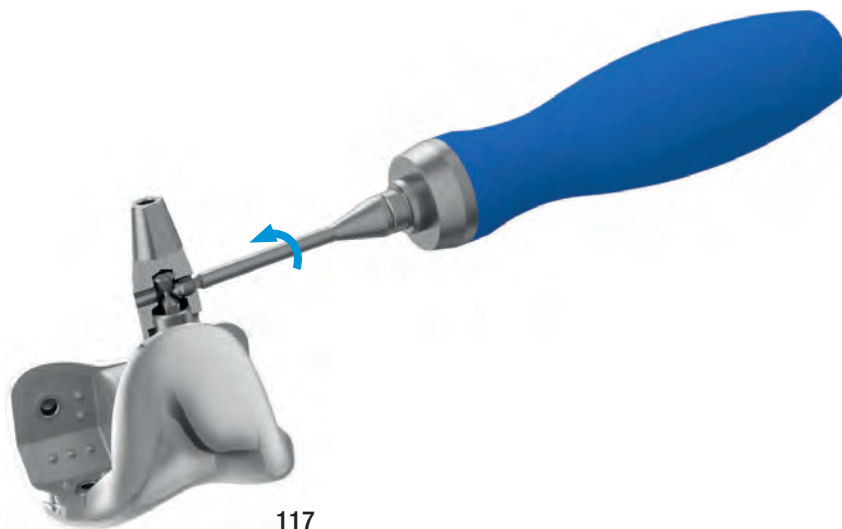

117

Finalize the implantation following the steps illustrated at pag 41.

Instruments



445-207/00
Impactor/Extractor
Handle



881-040/99
Tibial Femoral Coupling Base Tip



15-2545
Torque Wrench, hex 2.5 mm

Appendix 4 Valgus/Varus Tibial Recut

2° Valgus Recut Guide

If a 2° valgus correction cut is needed, place the Tibial Cutting Block Valgus re-cut on the proximal cut of the resected tibia, aligning with the previously defined A/P axis of the tibia (112).

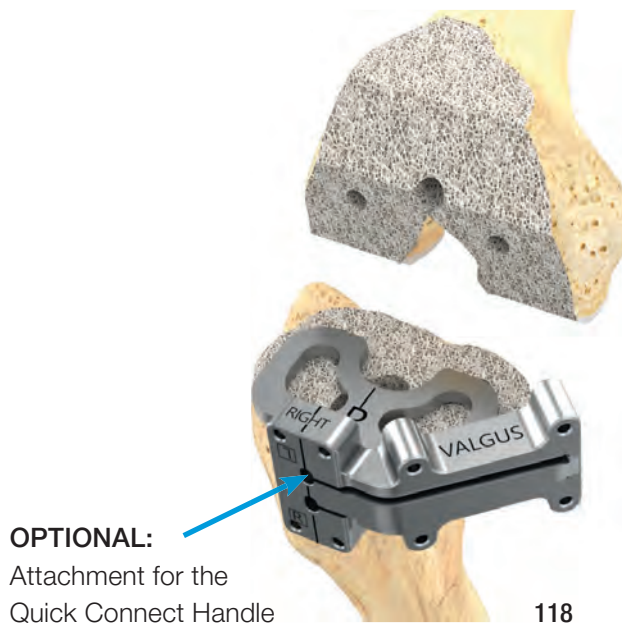

Once it has been determined that the desired correction cut will be attained, slide the medial portion of the Tibial Cutting Block Valgus re-cut so it is flush with the medial portion of the tibial cortex to provide a planar recut of the tibia.

Confirm the tibial resection plane using Cutting Template introduced as a free saw blade into the Cutting Block. Perform resection. Remove the pins and the Tibial cutting Block Valgus re-cut.

2° Varus Recut Guide

If a 2° varus correction cut is needed, place the Tibial Cutting Block Varus re-cut on the resected tibial plateau, aligning with the previously defined A/P axis of the tibia (113).

Once it has been determined that the desired correction cut will be attained, slide the lateral portion of the Tibial Cutting Block Varus re-cut so it is flush with the lateral portion of the tibial cortex to provide a planar recut of the tibia.

Confirm the tibial resection plane using Cutting Template introduced as a free saw blade into the Cutting Block.

Perform resection. Remove the pins and the Tibial Cutting Block Varus re-cut.

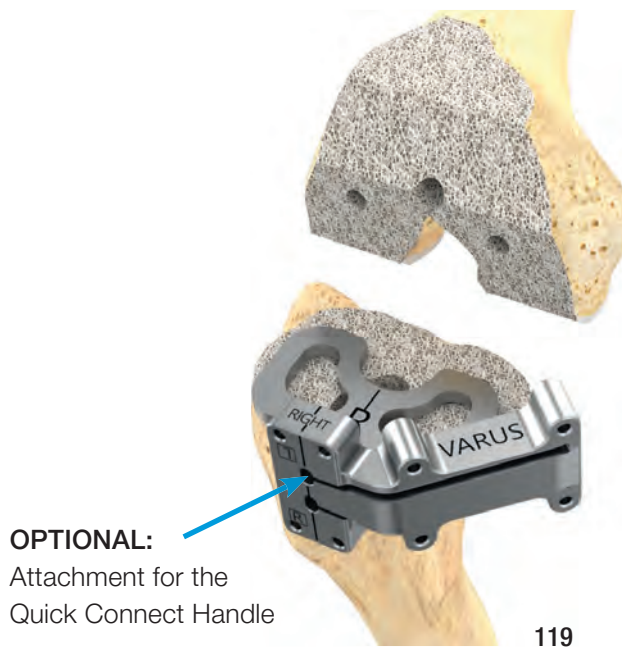

Instruments



881-299/00
Tibial Cutting Block Varus re-cut



881-299/10
Tibial Cutting Block Valgus re-cut

LinkSymphoKnee

Implants Combination Overview

Patella



Additional Implants

Femoral Components



CR

Articulating Surfaces

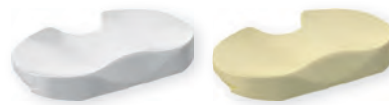

CR

Tibial Components



Not modular

Additional Implants

In the following pages are listed and described all implants and instruments for the CR, PS, PS+ configurations, including the CCK femoral component and cemented modular stems with no offset.

For all other implants and instruments, refer to the *LinkSymphoKnee* CCK Surgical Technique.

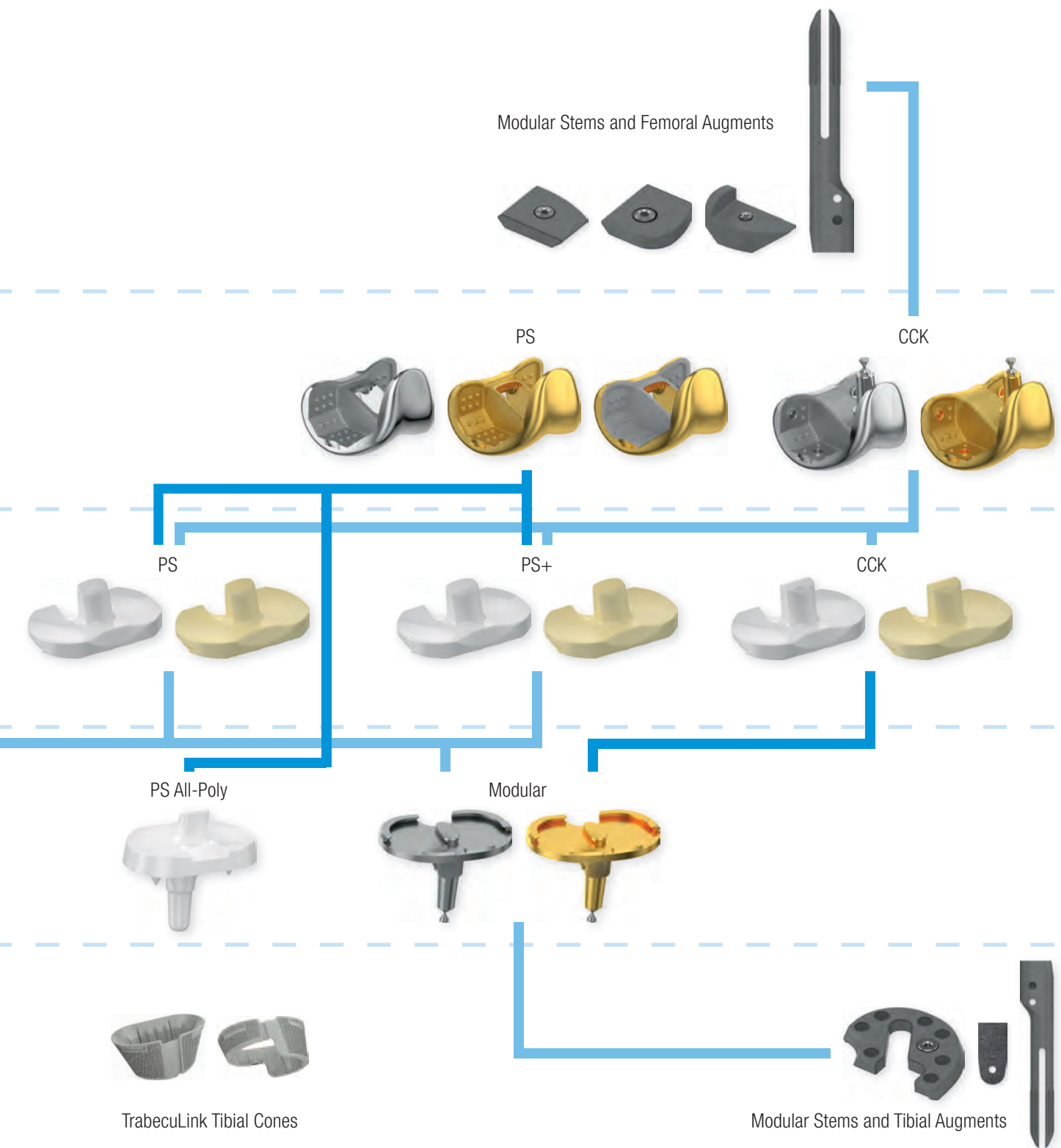

LinkSymphoKnee Femoral Components – CR Micro-Sizes

cemented



REF MAT CoCrMo	REF MAT CoCrMo LINK PorEx*	Size	Side	AP mm	ML mm
880-010/00#	880-060/00#	0	right	47	53.5
880-010/10#	880-060/10#	1	right	50	56
880-010/20#	880-060/20#	2	right	53	58.5
880-011/00#	880-061/00#	0	left	47	53.5
880-011/10#	880-061/10#	1	left	50	56
880-011/20#	880-061/20#	2	left	53	58.5

LinkSymphoKnee Femoral Components – CR

cemented



REF MAT CoCrMo	REF MAT CoCrMo LINK PorEx*	Size	Side	AP mm	ML mm
880-010/30	880-060/30	3	right	56	61
880-010/40	880-060/40	4	right	59	63.5
880-010/50	880-060/50	5	right	62	66
880-010/60	880-060/60	6	right	65	69
880-010/70	880-060/70	7	right	68	72
880-010/80	880-060/80	8	right	71	75
880-011/30	880-061/30	3	left	56	61
880-011/40	880-061/40	4	left	59	63.5
880-011/50	880-061/50	5	left	62	66
880-011/60	880-061/60	6	left	65	69
880-011/70	880-061/70	7	left	68	72
880-011/80	880-061/80	8	left	71	75

* LINK PorEx: TiNbN = Titanium Niobium Nitride (gold color).

Upon request

LinkSymphoKnee Femoral Components – CR Macro-Sizes

cemented



REF MAT CoCrMo	REF MAT CoCrMo LINK PorEx*	Size	Side	AP mm	ML mm
880-010/90#	880-060/90#	9	right	74	78
880-010/X0#	880-060/X0#	10	right	77	81
880-011/90#	880-061/90#	9	left	74	78
880-011/X0#	880-061/X0#	10	left	77	81

LinkSymphoKnee Femoral Components – CR Wide-Sizes

cemented



REF MAT CoCrMo	REF MAT CoCrMo LINK PorEx*	Size	Side	AP mm	ML mm
880-010/35#	880-060/35#	3+	right	56	63.5
880-010/45#	880-060/45#	4+	right	59	66
880-010/55#	880-060/55#	5+	right	62	69
880-011/35#	880-061/35#	3+	left	56	63.5
880-011/45#	880-061/45#	4+	left	59	66
880-011/55#	880-061/55#	5+	left	62	69

* LINK PorEx: TiNbN = Titanium Niobium Nitride (gold color).

Upon request

LinkSymphoKnee Femoral Components – CR Micro-Sizes

cementless

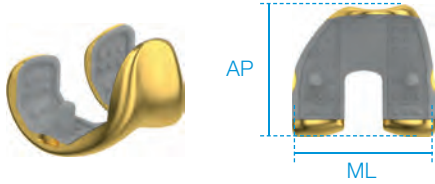

REF MAT CoCrMo LINK PorEx* / TiCaP**	Size	Side	AP mm	ML mm
880-110/00#	0	right	47	53.5
880-110/10#	1	right	50	56
880-110/20#	2	right	53	58.5
880-111/00#	0	left	47	53.5
880-111/10#	1	left	50	56
880-111/20#	2	left	53	58.5

LinkSymphoKnee Femoral Components – CR

cementless

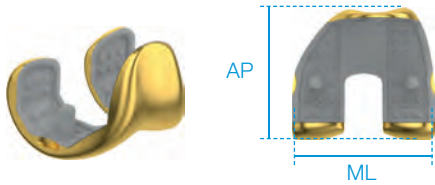

REF MAT CoCrMo LINK PorEx* / TiCaP**	Size	Side	AP mm	ML mm
880-110/30#	3	right	56	61
880-110/40#	4	right	59	63.5
880-110/50#	5	right	62	66
880-110/60#	6	right	65	69
880-110/70#	7	right	68	72
880-110/80#	8	right	71	75
880-111/30#	3	left	56	61
880-111/40#	4	left	59	63.5
880-111/50#	5	left	62	66
880-111/60#	6	left	65	69
880-111/70#	7	left	68	72
880-111/80#	8	left	71	75

* LINK PorEx: TiNbN = Titanium Niobium Nitride (gold color).
 ** TiCaP double coating: Titanium/Calcium Phosphate (CaP).
 # Upon request

LinkSymphoKnee Femoral Components – CR Macro-Sizes

cementless

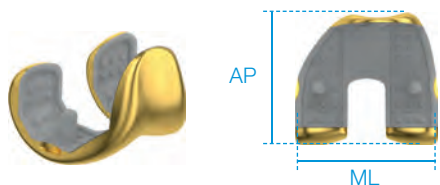

REF MAT CoCrMo LINK PorEx* / TiCaP**	Size	Side	AP mm	ML mm
880-110/90#	9	right	74	78
880-110/X0#	10	right	77	81
880-111/90#	9	left	74	78
880-111/X0#	10	left	77	81

LinkSymphoKnee Femoral Components – CR Wide-Sizes

cementless

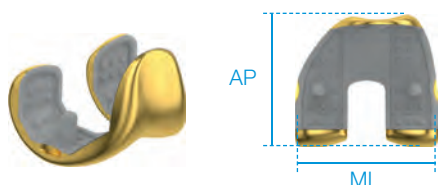

REF MAT CoCrMo LINK PorEx* / TiCaP**	Size	Side	AP mm	ML mm
880-110/35#	3+	right	56	63.5
880-110/45#	4+	right	59	66
880-110/55#	5+	right	62	69
880-111/35#	3+	left	56	63.5
880-111/45#	4+	left	59	66
880-111/55#	5+	left	62	69

* LINK PorEx: TiNbN = Titanium Niobium Nitride (gold color).
 ** TiCaP double coating: Titanium/Calcium Phosphate (CaP).
 # Upon request

LinkSymphoKnee Femoral Components – PS Micro-Sizes

cemented



REF MAT CoCrMo	REF MAT CoCrMo LINK PorEx*	Size	Side	AP mm	ML mm
880-020/00#	880-070/00#	0	right	47	53.5
880-020/10#	880-070/10#	1	right	50	56
880-020/20#	880-070/20#	2	right	53	58.5
880-021/00#	880-071/00#	0	left	47	53.5
880-021/10#	880-071/10#	1	left	50	56
880-021/20#	880-071/20#	2	left	53	58.5

LinkSymphoKnee Femoral Components – PS

cemented

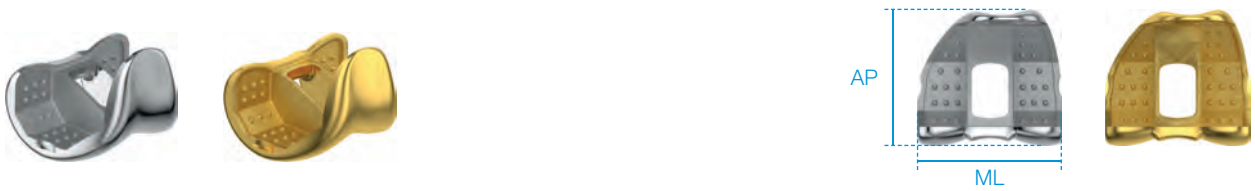

REF MAT CoCrMo	REF MAT CoCrMo LINK PorEx*	Size	Side	AP mm	ML mm
880-020/30	880-070/30	3	right	56	61
880-020/40	880-070/40	4	right	59	63.5
880-020/50	880-070/50	5	right	62	66
880-020/60	880-070/60	6	right	65	69
880-020/70	880-070/70	7	right	68	72
880-020/80	880-070/80	8	right	71	75
880-021/30	880-071/30	3	left	56	61
880-021/40	880-071/40	4	left	59	63.5
880-021/50	880-071/50	5	left	62	66
880-021/60	880-071/60	6	left	65	69
880-021/70	880-071/70	7	left	68	72
880-021/80	880-071/80	8	left	71	75

* LINK PorEx: TiNbN = Titanium Niobium Nitride (gold color).
Upon request

LinkSymphoKnee Femoral Components – PS Macro-Sizes

cemented



REF MAT CoCrMo	REF MAT CoCrMo LINK PorEx*	Size	Side	AP mm	ML mm
880-020/90#	880-070/90#	9	right	74	78
880-020/X0#	880-070/X0#	10	right	77	81
880-021/90#	880-071/90#	9	left	74	78
880-021/X0#	880-071/X0#	10	left	77	81

LinkSymphoKnee Femoral Components – PS Wide-Sizes

cemented



REF MAT CoCrMo	REF MAT CoCrMo LINK PorEx*	Size	Side	AP mm	ML mm
880-020/35#	880-070/35#	3+	right	56	63.5
880-020/45#	880-070/45#	4+	right	59	66
880-020/55#	880-070/55#	5+	right	62	69
880-021/35#	880-071/35#	3+	left	56	63.5
880-021/45#	880-071/45#	4+	left	59	66
880-021/55#	880-071/55#	5+	left	62	69

* LINK PorEx: TiNbN = Titanium Niobium Nitride (gold color).

Upon request

LinkSymphoKnee Femoral Components – PS Micro-Sizes

cementless

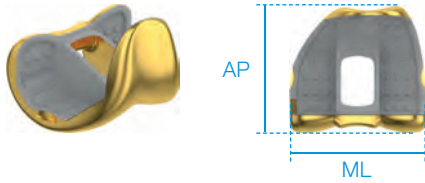

REF MAT	Size	Side	AP mm	ML mm
CoCrMo LINK PorEx* / TiCaP**				
880-120/00#	0	right	47	53.5
880-120/10#	1	right	50	56
880-120/20#	2	right	53	58.5
880-121/00#	0	left	47	53.5
880-121/10#	1	left	50	56
880-121/20#	2	left	53	58.5

LinkSymphoKnee Femoral Components – PS

cementless

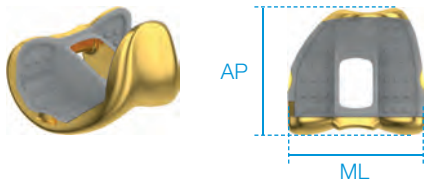

REF MAT	Size	Side	AP mm	ML mm
CoCrMo LINK PorEx* / TiCaP**				
880-120/30#	3	right	56	61
880-120/40#	4	right	59	63.5
880-120/50#	5	right	62	66
880-120/60#	6	right	65	69
880-120/70#	7	right	68	72
880-120/80#	8	right	71	75
880-121/30#	3	left	56	61
880-121/40#	4	left	59	63.5
880-121/50#	5	left	62	66
880-121/60#	6	left	65	69
880-121/70#	7	left	68	72
880-121/80#	8	left	71	75

* LINK PorEx: TiNbN = Titanium Niobium Nitride (gold color).
 ** TiCaP double coating: Titanium/Calcium Phosphate (CaP).
 # Upon request

LinkSymphoKnee Femoral Components – PS Macro-Sizes

cementless

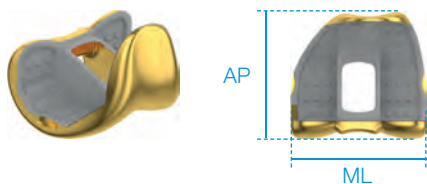

REF	Size	Side	AP mm	ML mm
MAT CoCrMo LINK PorEx* / TiCaP**				
880-120/90#	9	right	74	78
880-120/X0#	10	right	77	81
880-121/90#	9	left	74	78
880-121/X0#	10	left	77	81

LinkSymphoKnee Femoral Components – PS Wide-Sizes

cementless

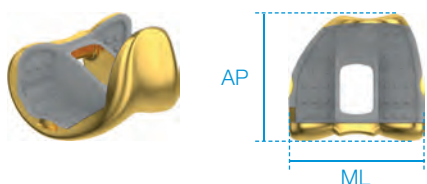

REF	Size	Side	AP mm	ML mm
MAT CoCrMo LINK PorEx* / TiCaP**				
880-120/35#	3+	right	56	63.5
880-120/45#	4+	right	59	66
880-120/55#	5+	right	62	69
880-121/35#	3+	left	56	63.5
880-121/45#	4+	left	59	66
880-121/55#	5+	left	62	69

* LINK PorEx: TiNbN = Titanium Niobium Nitride (gold color).

** TiCaP double coating: Titanium/Calcium Phosphate (CaP).

Upon request

LinkSymphoKnee Femoral Components – CCK Micro-Sizes

cemented



REF MAT CoCrMo	REF MAT CoCrMo LINK PorEx*	Size	Side	AP mm	ML mm
880-030/00#	880-080/00#	0	right	47	53.5
880-030/10#	880-080/10#	1	right	50	56
880-030/20#	880-080/20#	2	right	53	58.5
880-031/00#	880-081/00#	0	left	47	53.5
880-031/10#	880-081/10#	1	left	50	56
880-031/20#	880-081/20#	2	left	53	58.5

LinkSymphoKnee Femoral Components – CCK

cemented



REF MAT CoCrMo	REF MAT CoCrMo LINK PorEx*	Size	Side	AP mm	ML mm
880-030/30	880-080/30	3	right	56	61
880-030/40	880-080/40	4	right	59	63.5
880-030/50	880-080/50	5	right	62	66
880-030/60	880-080/60	6	right	65	69
880-030/70	880-080/70	7	right	68	72
880-030/80	880-080/80	8	right	71	75
880-031/30	880-081/30	3	left	56	61
880-031/40	880-081/40	4	left	59	63.5
880-031/50	880-081/50	5	left	62	66
880-031/60	880-081/60	6	left	65	69
880-031/70	880-081/70	7	left	68	72
880-031/80	880-081/80	8	left	71	75

* LINK PorEx: TiNbN = Titanium Niobium Nitride (gold color).
 ** Cone Adapter made of Ti6Al4V
 # Upon request

LinkSymphoKnee Femoral Components – CCK Macro-Sizes

cemented



REF MAT CoCrMo	REF MAT CoCrMo LINK PorEx*	Size	Side	AP mm	ML mm
880-030/90#	880-080/90#	9	right	74	78
880-030/X0#	880-080/X0#	10	right	77	81
880-031/90#	880-081/90#	9	left	74	78
880-031/X0#	880-081/X0#	10	left	77	81

LinkSymphoKnee Femoral Components – CCK Wide-Sizes

cemented



REF MAT CoCrMo	REF MAT CoCrMo LINK PorEx*	Size	Side	AP mm	ML mm
880-030/35#	880-080/35#	3+	right	56	63.5
880-030/45#	880-080/45#	4+	right	59	66
880-030/55#	880-080/55#	5+	right	62	69
880-031/35#	880-081/35#	3+	left	56	63.5
880-031/45#	880-081/45#	4+	left	59	66
880-031/55#	880-081/55#	5+	left	62	69

* LINK PorEx: TiNbN = Titanium Niobium Nitride (gold color).

** Cone Adapter made of Ti6Al4V

Upon request

LinkSymphoKnee Tibial Components – Monoblock Micro-Sizes

cemented



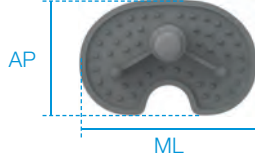





REF MAT CoCrMo	REF MAT CoCrMo LINK PorEx*	Size	AP mm	ML mm
880-040/10#	880-090/10#	1	37.5	59
880-040/20#	880-090/20#	2	40	62.5

LinkSymphoKnee Tibial Components – Monoblock

cemented

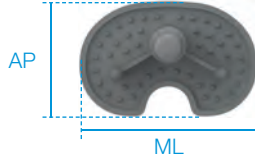







REF MAT CoCrMo	REF MAT CoCrMo LINK PorEx*	Size	AP mm	ML mm
880-040/30	880-090/30	3	42.5	66
880-040/40	880-090/40	4	45	69.5
880-040/50	880-090/50	5	47.5	73
880-040/60	880-090/60	6	50	76.5
880-040/70	880-090/70	7	52.5	80
880-040/80	880-090/80	8	55	83.5

LinkSymphoKnee Tibial Components – Monoblock Macro-Sizes

cemented

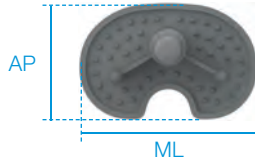





REF MAT CoCrMo	REF MAT CoCrMo LINK PorEx*	Size	AP mm	ML mm
880-040/90#	880-090/90#	9	57.5	87
880-040/X0#	880-090/X0#	10	60	90.5

* LINK PorEx: TiNbN = Titanium Niobium Nitride (gold color).

Upon request

LinkSymphoKnee Tibial Components – Monoblock Micro-Sizes

cementless

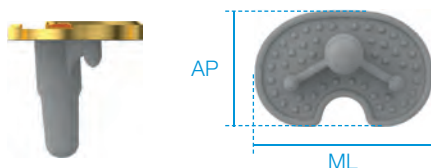

REF	Size	AP mm	ML mm
MAT CoCrMo LINK PorEx* / TiCaP**			
880-130/10#	1	37.5	59
880-130/20#	2	40	62.5

LinkSymphoKnee Tibial Components – Monoblock

cementless

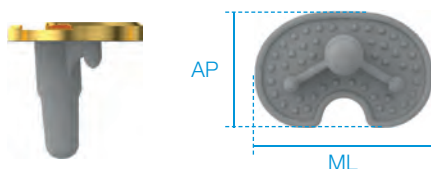

REF	Size	AP mm	ML mm
MAT CoCrMo LINK PorEx* / TiCaP**			
880-130/30#	3	42.5	66
880-130/40#	4	45	69.5
880-130/50#	5	47.5	73
880-130/60#	6	50	76.5
880-130/70#	7	52.5	80
880-130/80#	8	55	83.5

LinkSymphoKnee Tibial Components – Monoblock Macro-Sizes

cementless

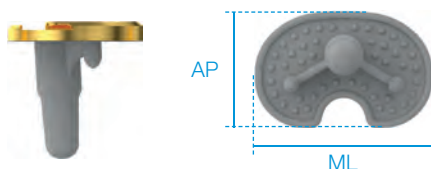

REF	Size	AP mm	ML mm
MAT CoCrMo LINK PorEx* / TiCaP**			
880-130/90#	9	57.5	87
880-130/X0#	10	60	90.5

* LINK PorEx: TiNbN = Titanium Niobium Nitride (gold color).
 ** TiCaP double coating: Titanium/Calcium Phosphate (CaP).
 # Upon request

LinkSymphoKnee Tibial Components – Modular Micro-Sizes

cemented				
REF	REF	Size	AP mm	ML mm
MAT CoCrMo	MAT CoCrMo LINK PorEx*			
880-050/10#	880-100/10#	1	37.5	59
880-050/20#	880-100/20#	2	40	62.5

LinkSymphoKnee Tibial Components – Modular

cemented				
REF	REF	Size	AP mm	ML mm
MAT CoCrMo	MAT CoCrMo LINK PorEx*			
880-050/30	880-100/30	3	42.5	66
880-050/40	880-100/40	4	45	69.5
880-050/50	880-100/50	5	47.5	73
880-050/60	880-100/60	6	50	76.5
880-050/70	880-100/70	7	52.5	80
880-050/80	880-100/80	8	55	83.5

LinkSymphoKnee Tibial Components – Modular Macro-Sizes

cemented				
REF	REF	Size	AP mm	ML mm
MAT CoCrMo	MAT CoCrMo LINK PorEx*			
880-050/90#	880-100/90#	9	57.5	87
880-050/X0#	880-100/X0#	10	60	90.5

* LINK PorEx: TiNbN = Titanium Niobium Nitride (gold color).
 ** Cone Adapter made of Ti6Al4V
 # Upon request

LinkSymphoKnee Taper Cap

cemented



REF MAT CoCrMo	REF MAT CoCrMo LINK PorEx*	Ø mm
880-700/00	880-700/10	16

LinkSymphoKnee Patella Components – 3-peg

cemented

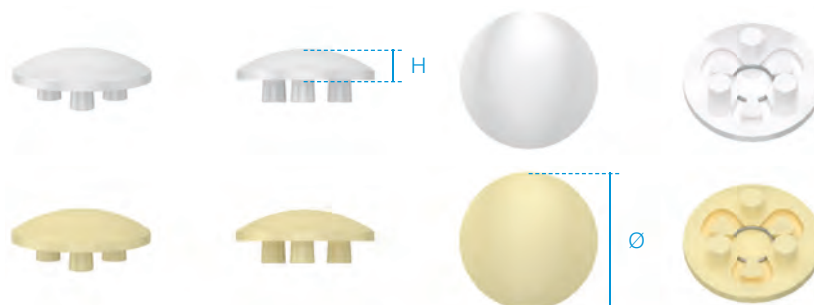

REF MAT UHMWPE	REF MAT E-Dur**	Ø mm	Height (H) mm
880-501/25	880-511/25 [#]	25	6
880-501/28	880-511/28 [#]	28	6
880-501/31	880-511/31 [#]	31	7
880-501/34	880-511/34 [#]	34	8
880-501/37	880-511/37 [#]	37	9
880-501/40	880-511/40 [#]	40	10

* LINK PorEx: TiNbN = Titanium Niobium Nitride (gold color).
 ** E-Dur = Highly crosslinked UHMWPE (X-Linked PE) with Vit-E
[#] Upon request

LinkSymphoKnee Articulating Surfaces – CR Micro-Sizes

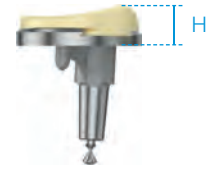
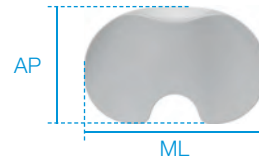

REF MAT UHMWPE	REF MAT E-Dur*	Size	AP mm	ML mm	Height (H) mm
880-201/10#	880-241/10#	1-2	37.5	59	10
880-201/11#	880-241/11#	1-2	37.5	59	11
880-201/12#	880-241/12#	1-2	37.5	59	12
880-201/14#	880-241/14#	1-2	37.5	59	14
880-201/16#	880-241/16#	1-2	37.5	59	16
880-201/18#	880-241/18#	1-2	37.5	59	18

LinkSymphoKnee Articulating Surfaces – CR

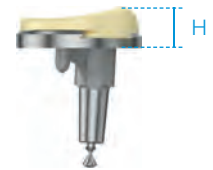
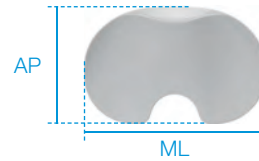
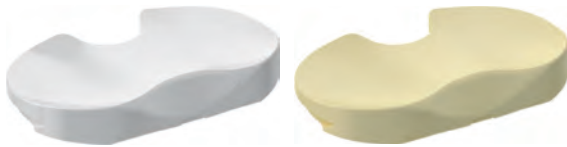

REF MAT UHMWPE	REF MAT E-Dur*	Size	AP mm	ML mm	Height (H) mm
880-203/10	880-243/10#	3-4	42.5	66	10
880-203/11	880-243/11#	3-4	42.5	66	11
880-203/12	880-243/12#	3-4	42.5	66	12
880-203/14	880-243/14#	3-4	42.5	66	14
880-203/16	880-243/16#	3-4	42.5	66	16
880-203/18	880-243/18#	3-4	42.5	66	18
880-205/10	880-245/10#	5-6	47.5	73	10
880-205/11	880-245/11#	5-6	47.5	73	11
880-205/12	880-245/12#	5-6	47.5	73	12
880-205/14	880-245/14#	5-6	47.5	73	14
880-205/16	880-245/16#	5-6	47.5	73	16
880-205/18	880-245/18#	5-6	47.5	73	18
880-207/10	880-247/10#	7-8	52.5	80	10
880-207/11	880-247/11#	7-8	52.5	80	11
880-207/12	880-247/12#	7-8	52.5	80	12
880-207/14	880-247/14#	7-8	52.5	80	14
880-207/16	880-247/16#	7-8	52.5	80	16
880-207/18	880-247/18#	7-8	52.5	80	18

* E-Dur = Highly crosslinked UHMWPE (X-Linked PE) with Vit-E
 # Upon request

LinkSymphoKnee Articulating Surfaces – CR Macro-Sizes

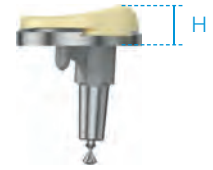
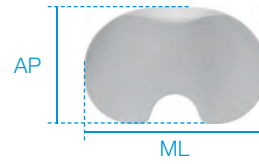

REF MAT UHMWPE	REF MAT E-Dur*	Size	AP mm	ML mm	Height (H) mm
880-209/10#	880-249/10#	9-10	57.5	87	10
880-209/11#	880-249/11#	9-10	57.5	87	11
880-209/12#	880-249/12#	9-10	57.5	87	12
880-209/14#	880-249/14#	9-10	57.5	87	14
880-209/16#	880-249/16#	9-10	57.5	87	16
880-209/18#	880-249/18#	9-10	57.5	87	18

* E-Dur = Highly crosslinked UHMWPE (X-Linked PE) with Vit-E
 # Upon request

LinkSymphoKnee Articulating Surfaces – PS Micro-Sizes



REF MAT UHMWPE	REF MAT E-Dur*	Size	AP mm	ML mm	Height (H) mm
880-211/10#	880-251/10#	1-2	37.5	59	10
880-211/11#	880-251/11#	1-2	37.5	59	11
880-211/12#	880-251/12#	1-2	37.5	59	12
880-211/14#	880-251/14#	1-2	37.5	59	14
880-211/16#	880-251/16#	1-2	37.5	59	16
880-211/18#	880-251/18#	1-2	37.5	59	18
880-212/10#	880-252/10#	1-2up	37.5	59	10
880-212/11#	880-252/11#	1-2up	37.5	59	11
880-212/12#	880-252/12#	1-2up	37.5	59	12
880-212/14#	880-252/14#	1-2up	37.5	59	14
880-212/16#	880-252/16#	1-2up	37.5	59	16
880-212/18#	880-252/18#	1-2up	37.5	59	18

* E-Dur = Highly crosslinked UHMWPE (X-Linked PE) with Vit-E
 # Upon request

LinkSymphoKnee Articulating Surfaces – PS

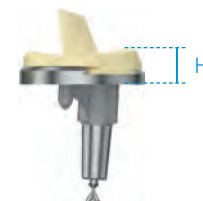
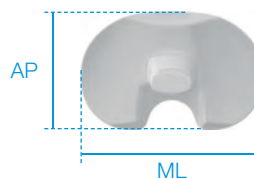

REF MAT UHMWPE	REF MAT E-Dur*	Size	AP mm	ML mm	Height (H) mm
880-213/10	880-253/10#	3-4	42.5	66	10
880-213/11	880-253/11#	3-4	42.5	66	11
880-213/12	880-253/12#	3-4	42.5	66	12
880-213/14	880-253/14#	3-4	42.5	66	14
880-213/16	880-253/16#	3-4	42.5	66	16
880-213/18	880-253/18#	3-4	42.5	66	18
880-214/10	880-254/10#	3-4down	42.5	66	10
880-214/11	880-254/11#	3-4down	42.5	66	11
880-214/12	880-254/12#	3-4down	42.5	66	12
880-214/14	880-254/14#	3-4down	42.5	66	14
880-214/16	880-254/16#	3-4down	42.5	66	16
880-214/18	880-254/18#	3-4down	42.5	66	18
880-215/10	880-255/10#	5-6	47.5	73	10
880-215/11	880-255/11#	5-6	47.5	73	11
880-215/12	880-255/12#	5-6	47.5	73	12
880-215/14	880-255/14#	5-6	47.5	73	14
880-215/16	880-255/16#	5-6	47.5	73	16
880-215/18	880-255/18#	5-6	47.5	73	18
880-217/10	880-257/10#	7-8	52.5	80	10
880-217/11	880-257/11#	7-8	52.5	80	11
880-217/12	880-257/12#	7-8	52.5	80	12
880-217/14	880-257/14#	7-8	52.5	80	14
880-217/16	880-257/16#	7-8	52.5	80	16
880-217/18	880-257/18#	7-8	52.5	80	18

LinkSymphoKnee Articulating Surfaces – PS Macro-Sizes

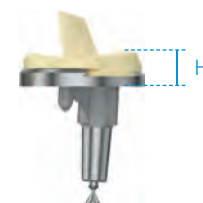
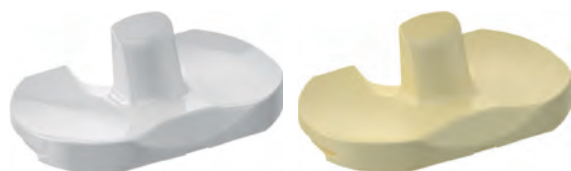

REF MAT UHMWPE	REF MAT E-Dur*	Size	AP mm	ML mm	Height (H) mm
880-219/10#	880-259/10#	9-10	57.5	87	10
880-219/11#	880-259/11#	9-10	57.5	87	11
880-219/12#	880-259/12#	9-10	57.5	87	12
880-219/14#	880-259/14#	9-10	57.5	87	14
880-219/16#	880-259/16#	9-10	57.5	87	16
880-219/18#	880-259/18#	9-10	57.5	87	18

* E-Dur = Highly crosslinked UHMWPE (X-Linked PE) with Vit-E
 # Upon request

LinkSymphoKnee Articulating Surfaces – PS+ Micro-Sizes

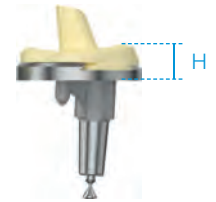
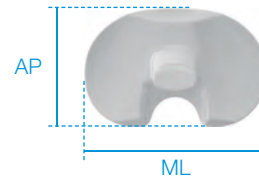
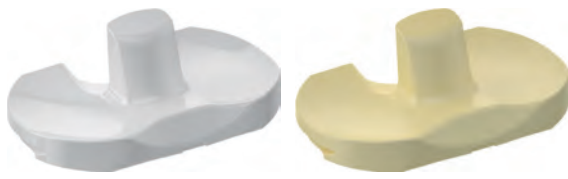

REF MAT UHMWPE	REF MAT E-Dur*	Size	AP mm	ML mm	Height (H) mm
880-221/10#	880-261/10#	1-2	37.5	59	10
880-221/11#	880-261/11#	1-2	37.5	59	11
880-221/12#	880-261/12#	1-2	37.5	59	12
880-221/14#	880-261/14#	1-2	37.5	59	14
880-221/16#	880-261/16#	1-2	37.5	59	16
880-221/18#	880-261/18#	1-2	37.5	59	18
880-222/10#	880-262/10#	1-2up	37.5	59	10
880-222/11#	880-262/11#	1-2up	37.5	59	11
880-222/12#	880-262/12#	1-2up	37.5	59	12
880-222/14#	880-262/14#	1-2up	37.5	59	14
880-222/16#	880-262/16#	1-2up	37.5	59	16
880-222/18#	880-262/18#	1-2up	37.5	59	18

* E-Dur = Highly crosslinked UHMWPE (X-Linked PE) with Vit-E
 # Upon request

LinkSymphoKnee Articulating Surfaces – PS+

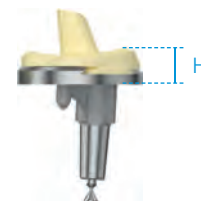
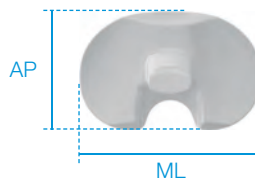
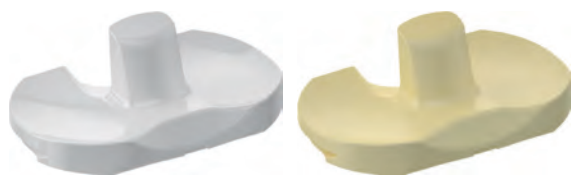

REF MAT UHMWPE	REF MAT E-Dur*	Size	AP mm	ML mm	Height (H) mm
880-223/10	880-263/10#	3-4	42.5	66	10
880-223/11	880-263/11#	3-4	42.5	66	11
880-223/12	880-263/12#	3-4	42.5	66	12
880-223/14	880-263/14#	3-4	42.5	66	14
880-223/16	880-263/16#	3-4	42.5	66	16
880-223/18	880-263/18#	3-4	42.5	66	18
880-224/10	880-264/10#	3-4down	42.5	66	10
880-224/11	880-264/11#	3-4down	42.5	66	11
880-224/12	880-264/12#	3-4down	42.5	66	12
880-224/14	880-264/14#	3-4down	42.5	66	14
880-224/16	880-264/16#	3-4down	42.5	66	16
880-224/18	880-264/18#	3-4down	42.5	66	18
880-225/10	880-265/10#	5-6	47.5	73	10
880-225/11	880-265/11#	5-6	47.5	73	11
880-225/12	880-265/12#	5-6	47.5	73	12
880-225/14	880-265/14#	5-6	47.5	73	14
880-225/16	880-265/16#	5-6	47.5	73	16
880-225/18	880-265/18#	5-6	47.5	73	18
880-227/10	880-267/10#	7-8	52.5	80	10
880-227/11	880-267/11#	7-8	52.5	80	11
880-227/12	880-267/12#	7-8	52.5	80	12
880-227/14	880-267/14#	7-8	52.5	80	14
880-227/16	880-267/16#	7-8	52.5	80	16
880-227/18	880-267/18#	7-8	52.5	80	18

LinkSymphoKnee Articulating Surfaces – PS+ Macro-Sizes

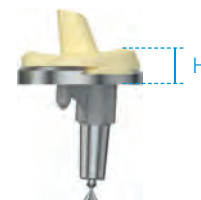
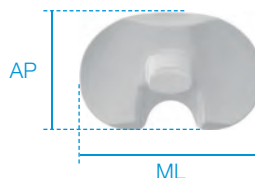
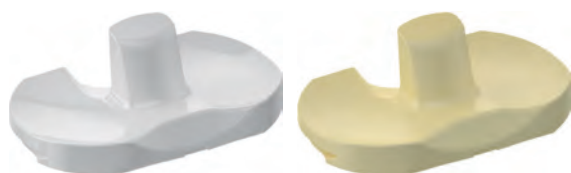

REF MAT UHMWPE	REF MAT E-Dur*	Size	AP mm	ML mm	Height (H) mm
880-229/10#	880-269/10#	9-10	57.5	87	10
880-229/11#	880-269/11#	9-10	57.5	87	11
880-229/12#	880-269/12#	9-10	57.5	87	12
880-229/14#	880-269/14#	9-10	57.5	87	14
880-229/16#	880-269/16#	9-10	57.5	87	16
880-229/18#	880-269/18#	9-10	57.5	87	18

* E-Dur = Highly crosslinked UHMWPE (X-Linked PE) with Vit-E

Upon request

LinkSymphoKnee Tibial Components – All-Poly PS Micro-Sizes

cemented

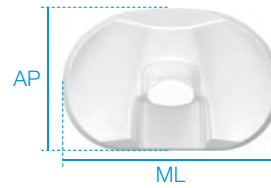

REF MAT	Size	AP mm	ML mm	Height (H) mm
880-411/11#	1	37.5	59	10
880-411/12#	1	37.5	59	12
880-411/13#	1	37.5	59	14
880-411/21#	1up	37.5	59	10
880-411/22#	1up	37.5	59	12
880-411/23#	1up	37.5	59	14
880-412/11#	2	40	62.5	10
880-412/12#	2	40	62.5	12
880-412/13#	2	40	62.5	14
880-412/21#	2up	40	62.5	10
880-412/22#	2up	40	62.5	12
880-412/23#	2up	40	62.5	14

Upon request

LinkSymphoKnee Tibial Components – All-Poly PS

cemented

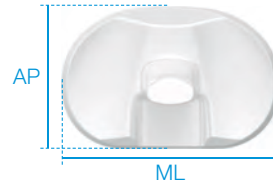

REF MAT UHMWPE	Size	AP mm	ML mm	Height (H) mm
880-413/11	3	42.5	66	10
880-413/12	3	42.5	66	12
880-413/13	3	42.5	66	14
880-413/21 [#]	3down	42.5	66	10
880-413/22 [#]	3down	42.5	66	12
880-413/23 [#]	3down	42.5	66	14
880-414/11	4	45	69.5	10
880-414/12	4	45	69.5	12
880-414/13	4	45	69.5	14
880-414/21 [#]	4down	45	69.5	10
880-414/22 [#]	4down	45	69.5	12
880-414/23 [#]	4down	45	69.5	14
880-415/11	5	47.5	73	10
880-415/12	5	47.5	73	12
880-415/13	5	47.5	73	14
880-416/11	6	50	76.5	10
880-416/12	6	50	76.5	12
880-416/13	6	50	76.5	14
880-417/11	7	52.5	80	10
880-417/12	7	52.5	80	12
880-417/13	7	52.5	80	14
880-418/11	8	55	83.5	10
880-418/12	8	55	83.5	12
880-418/13	8	55	83.5	14

LinkSymphoKnee Tibial Components – All-Poly PS Macro-Sizes

cemented

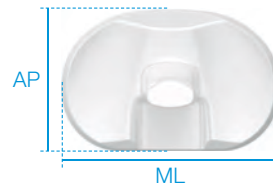

REF MAT UHMWPE	Size	AP mm	ML mm	Height (H) mm
880-419/11 [#]	9	57.5	87	10
880-419/12 [#]	9	57.5	87	12
880-419/13 [#]	9	57.5	87	14
880-41X/11 [#]	10	60	90.5	10
880-41X/12 [#]	10	60	90.5	12
880-41X/13 [#]	10	60	90.5	14

[#] Upon request

Cemented Stems

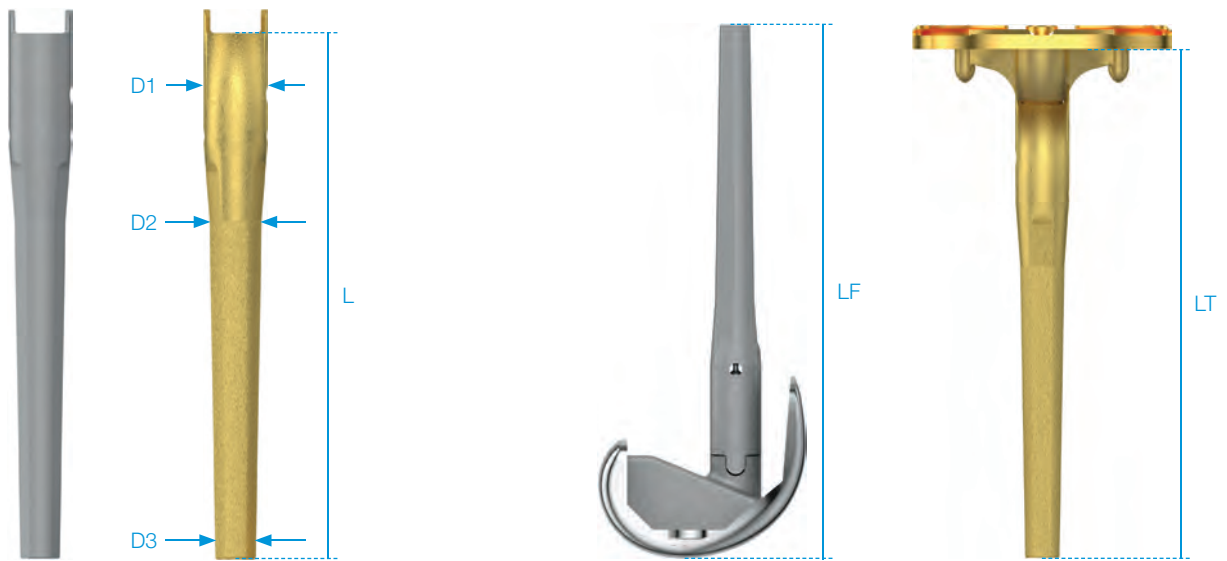

REF	REF	D1	D2	D3	L	LF	LT
MAT	MAT	mm	mm	mm	mm	mm	mm
CoCrMo	CoCrMo LINK PorEx*						
15-2950/17#	15-3950/17#	16	11	8	50	85	68
15-2950/12#	15-3950/12#	16	10	7	80	115	98
15-2950/37#	15-3950/37#	16	15	12	95	130	113
15-2950/38#	15-3950/38#	16	15	12	120	155	138

Centralizers

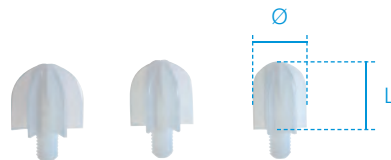

REF	Ø	Length (L)
MAT	mm	mm
UHMWPE		
15-2975/12#	12	15
15-2975/14#	14	15
15-2975/16#	16	15
15-2975/18#	18	15
15-2975/20#	20	15
15-2975/22#	22	15
15-2975/24#	24	15

* LINK PorEx: TiNbN = Titanium Niobium Nitride (gold color).
Upon request

Replacement Set for Cone Adapter



REF	REF
MAT Tilastan*/CoCrMo	MAT Tilastan*/CoCrMo LINK PorEx**
15-6118/29	15-6118/30

Each package contains:

- One Cone Adapter
- Two Security Screws

* Tilastan = Ti6Al4V

** LINK PorEx: TiNbN = Titanium Niobium Nitride (gold color).

LinkSymphoKnee **Basic Instruments**

REF	Basic Instruments	CR	PS	PS+	CCK with short straight stem
881-001/00	General Instruments – Blue feet	X	X	X	X
881-002/10	Femoral/Tibial Instruments – Blue feet	X	X	X	X
881-003/10	CR Instruments & Trials – Green feet	X			
881-004/10	PS Instruments & Trials – Grey feet		X	X	X
881-005/00	PS+ Articulating Surfaces Trials – Grey feet			X	
881-006/10	CCK Instruments & Trials – Yellow feet				X
	Additional Instrument Set:				
881-009/00	Patella Instruments & Trials – Blue feet				

LinkSymphoKnee **Micro-Sizes Instruments**

To the Basic Instruments listed above, add:

REF	Micro-Sizes Instruments	CR Micro-Sizes	PS Micro-Sizes	CCK with short straight stem Micro-Sizes
881-002/00#	Femoral/Tibial Instruments Micro-Sizes – Blue feet	X	X	X
881-003/00#	CR Instruments & Trials Micro-Sizes – Green feet	X		
881-004/00#	PS Instruments & Trials Micro-Sizes – Grey feet		X	X
881-006/00#	CCK Instruments & Trials Micro-Sizes – Yellow feet			X

LinkSymphoKnee **Macro-Sizes Instruments**

To the Basic Instruments listed above, add:

REF	Macro-Sizes Instruments	CR Macro-Sizes	PS Macro-Sizes	CCK with short straight stem Macro-Sizes
881-002/20#	Femoral/Tibial Instruments Macro-Sizes – Blue feet	X	X	X
881-003/20#	CR Instruments & Trials Macro-Sizes – Green feet	X		
881-004/20#	PS Instruments & Trials Macro-Sizes – Grey feet		X	X
881-006/20#	CCK Instruments & Trials Macro-Sizes – Yellow feet			X

LinkSymphoKnee **Wide-Sizes Instruments**

To the Basic Instruments listed above, add:

REF	Wide-Sizes Instruments	CR Wide-Sizes	PS Wide-Sizes	CCK with short straight stem Wide-Sizes
881-003/30#	CR Instruments & Trials Wide-Sizes – Green feet	X		
881-004/30#	PS Instruments & Trials Wide-Sizes – Grey feet		X	X
881-006/30#	CCK Instruments & Trials Wide-Sizes – Yellow feet			X

LinkSymphoKnee **Instruments upon request**

REF	Instruments upon request
445-126/65	Thread Pins, L = 65 mm, Ø 3.0 mm
445-126/95	Thread Pins, L = 95 mm, Ø 3.0 mm
445-127/35	Headed Thread Pins, L = 35 mm, Ø 3.0 mm
445-127/65	Headed Thread Pins, L = 65 mm, Ø 3.0 mm
881-211/08	Tibial Cutting Block, 8° Left
881-210/08	Tibial Cutting Block, 8° Right

Upon request

881-001/00 General Instruments – Blue feet

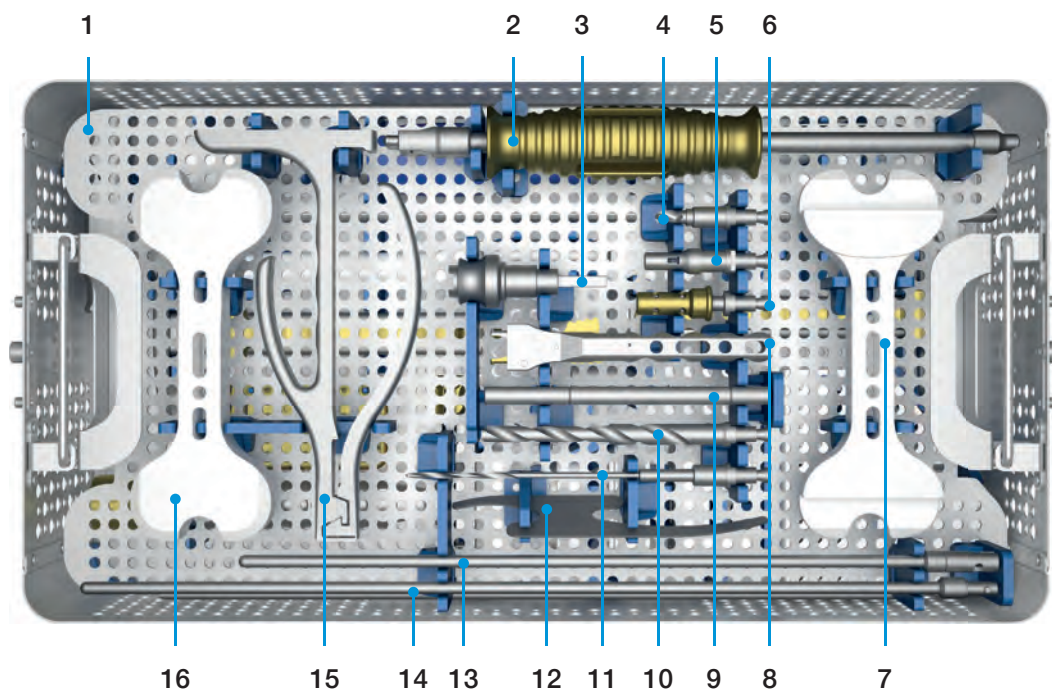

			Qty.
1	881-010/00	LinkSymphoKnee General Instruments Tray – Upper Tray	1
2	445-206/00	Slaphammer	1
3	16-3283/01	Adapter, Hudson/Jakobs Fitting (E)	1
4	881-012/00	Universal Drill	1
5	445-122/00	Power Driver, Hudson Fitting	1
6	445-122/10	Power Driver with snap lock, Hudson Fitting	1
7	881-011/02	Spacer 4-in-1 Cut, Flexion, H = 10-12 mm	1
8	445-112/00	Handle, Quick Connect	1
9	445-121/00	Pin Inserter, universal	1
10	319-505/00B	Step Drill, with Hudson Fitting (B)	1
11	15-2040/02B	Twist Drill 3 mm, Hudson Fitting	1
12	317-802/53	Cutting Template	1
13	445-113/10	Alignment Rod, extramedullary, short	1
14	445-113/20	Alignment Rod, extramedullary, long	1
15	445-120/00	Pin Inserter/Extractor, universal	1
16	881-010/02	Spacer Flexion/Extension, H = 10-12 mm	1

881-001/00 General Instruments – Blue feet

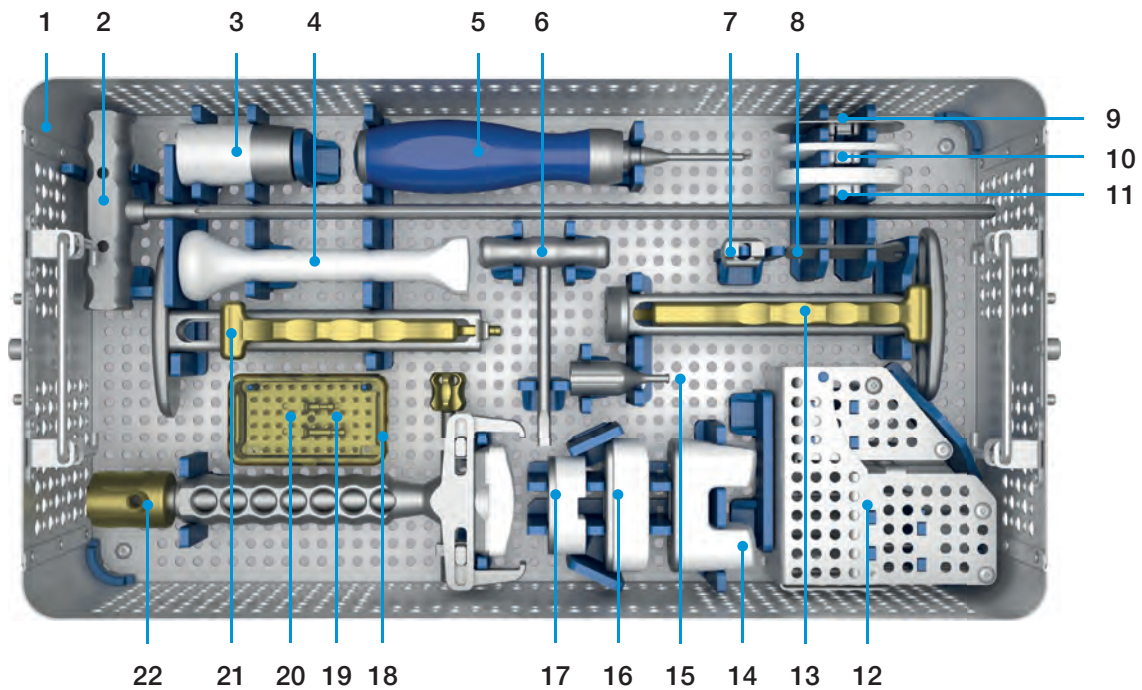

			Qty.
1	881-010/00	LinkSymphoKnee General Instruments Tray – Lower Tray	1
2	445-101/00	Intramedullary Rod, Ø 8.0 mm	1
3	881-040/99	Tibial/Femoral Coupling Base Tip	1
4	881-040/01	Articulating Surface Impactor	1
5	15-2545	Torque Wrench, hex 2.5 mm	1
6	881-019/00	Articulating Surface Extractor	1
7	881-043/00	Tibial Extractor Tip	1
8	151-131/00	Screwdriver for Cone Adapter	1
9	881-019/01	Shim, Spacer, H = 1 mm	1
10	881-019/04	Shim, Spacer, H = 4 mm	1
11	881-019/08	Shim, Spacer, H = 8 mm	1
12	445-123/00	Pin Box	1
	445-124/65	Drill Pin, L = 65 mm, Ø 3.0 mm	4
	445-124/95	Drill Pin, L = 95 mm, Ø 3.0 mm	4
	445-125/35	Drill Pin, Headed, L = 35 mm, Ø 3.0 mm	4
	445-125/65	Drill Pin, Headed, L = 65 mm, Ø 3.0 mm	4
	445-128/25	Bone Nail, L = 25 mm, Ø 3.0 mm	4
	445-128/35	Bone Nail, L = 35 mm, Ø 3.0 mm	4
	445-128/65	Bone Nail, L = 65 mm, Ø 3.0 mm	4
13	881-042/00	Tibial Inserter	1
14	881-042/90	Tibial Impactor Tip, All Poly	1
15	151-132/00	Modular Extractor Tip	1
16	881-041/99	Femoral Impactor Tip	1
17	881-042/99	Tibial Impactor Tip	1
18	881-053/00	Locking Screw Tibial Plateau, long	1
19	881-052/00	Locking Screw Tibial Plateau, short	1
20	319-601/30	Sterilizing Box, small	1
21	445-207/00	Handle, Impactor/Extractor	1
22	881-041/00	Femoral Inserter/Extractor	1

881-002/10 Femoral/Tibial Instruments – Blue feet

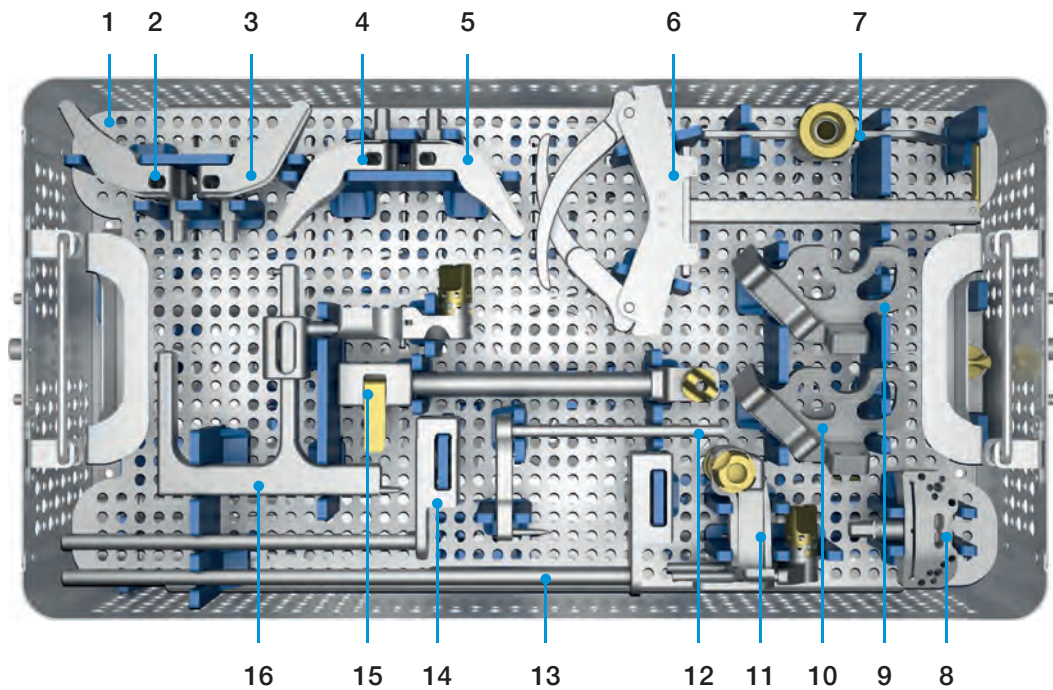

			Qty.
1	881-020/10	LinkSymphoKnee Femoral Instruments Tray – Upper Tray	1
2	445-110/10	Tibial Cutting Block, 0° Left	1
3	445-110/20	Tibial Cutting Block, 0° Right	1
4	881-211/03	Tibial Cutting Block, 3° Left	1
5	881-210/03	Tibial Cutting Block, 3° Right	1
6	445-105/00	EM Tibial Guide, Ankle Clamp	1
7	445-111/00	Stylus, adjustable	1
8	445-104/00	Femoral Cutting Block, distal cut	1
9	881-299/00	Tibial Cutting Block Varus re-cut	1
10	881-299/10	Tibial Cutting Block Valgus re-cut	1
11	445-102/00	Femoral Alignment Guide, Varus/Valgus Adjustment	1
12	445-108/00	EM Tibial Guide, Spike Rod	1
13	445-106/20	EM Tibial Guide Distal Rod, long	1
14	445-106/10	EM Tibial Guide Distal Rod, short	1
15	445-107/00	EM Tibial Guide, Proximal Tube	1
16	445-109/00	IM Tibial Guide	1

881-002/10 Femoral/Tibial Instruments – Blue feet

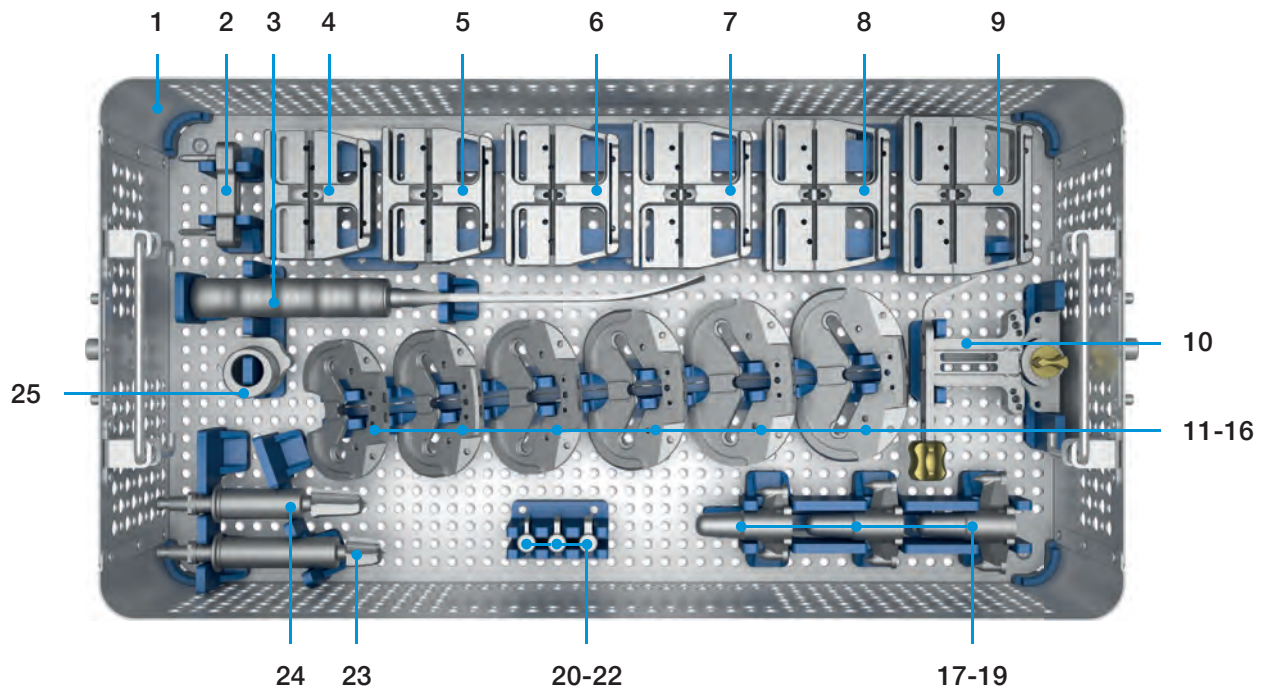

			Qty.
1	881-020/10	LinkSymphoKnee Femoral Instruments Tray – Lower Tray	1
2	881-019/03	A/P Femoral Shift Block +3 mm	1
3	445-208/00	Femoral Chisel, Varus/Valgus Adjustment	1
4	881-119/30	Posterior Reference, Femoral Cutting Block, 4-in-1 Cut, Size 3	1
5	881-119/40	Posterior Reference, Femoral Cutting Block, 4-in-1 Cut, Size 4	1
6	881-119/50	Posterior Reference, Femoral Cutting Block, 4-in-1 Cut, Size 5	1
7	881-119/60	Posterior Reference, Femoral Cutting Block, 4-in-1 Cut, Size 6	1
8	881-119/70	Posterior Reference, Femoral Cutting Block, 4-in-1 Cut, Size 7	1
9	881-119/80	Posterior Reference, Femoral Cutting Block, 4-in-1 Cut, Size 8	1
10	881-100/00	Femoral Sizing Guide, Posterior Reference	1
11	881-283/30	Fixed Bearing, Tibial Preparation Plate, Size 3	1
12	881-283/40	Fixed Bearing, Tibial Preparation Plate, Size 4	1
13	881-283/50	Fixed Bearing, Tibial Preparation Plate, Size 5	1
14	881-283/60	Fixed Bearing, Tibial Preparation Plate, Size 6	1
15	881-283/70	Fixed Bearing, Tibial Preparation Plate, Size 7	1
16	881-283/80	Fixed Bearing, Tibial Preparation Plate, Size 8	1
17	881-272/34	Tibial Keel Punch, Size 3-4	1
18	881-272/56	Tibial Keel Punch, Size 5-6	1
19	881-272/78	Tibial Keel Punch, Size 7-8	1
20	881-109/02	Shim, Femoral Sizing Guide, H = 2 mm	1
21	881-109/03	Shim, Femoral Sizing Guide, H = 3 mm	1
22	881-109/04	Shim, Femoral Sizing Guide, H = 4 mm	1
23	881-062/99	Tapered Reamer, Taper Cap	1
24	881-062/00	Tapered Reamer, Monoblock Tibia	1
25	881-216/00	Tibial Reamer Guide Ø 17 mm	1

881-003/10 CR Instruments & Trials – Green feet

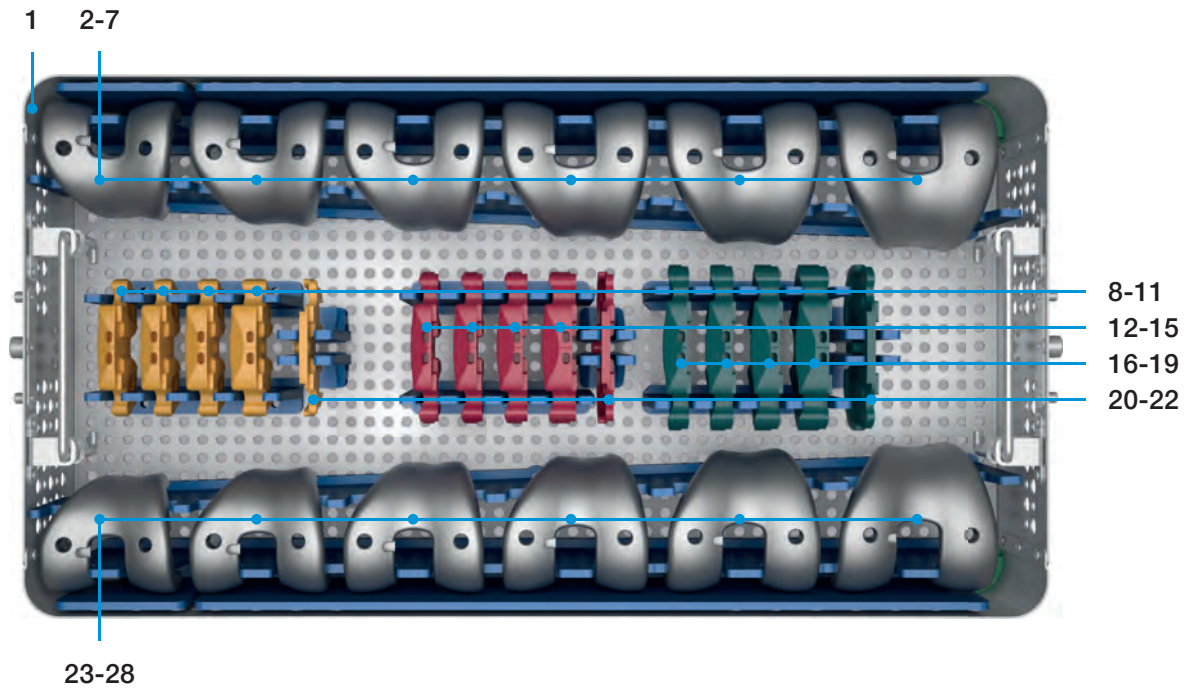

			Qty.
1	881-030/10	LinkSymphoKnee CR Instruments & Trials Tray	1
2	881-120/30	Femoral Trial, CR, right, Size 3	1
3	881-120/40	Femoral Trial, CR, right, Size 4	1
4	881-120/50	Femoral Trial, CR, right, Size 5	1
5	881-120/60	Femoral Trial, CR, right, Size 6	1
6	881-120/70	Femoral Trial, CR, right, Size 7	1
7	881-120/80	Femoral Trial, CR, right, Size 8	1
8	881-223/10	Trial Plateau, CR, Size 3-4, H = 10 mm	1
9	881-223/11	Trial Plateau, CR, Size 3-4, H = 11 mm	1
10	881-223/12	Trial Plateau, CR, Size 3-4, H = 12 mm	1
11	881-223/14	Trial Plateau, CR, Size 3-4, H = 14 mm	1
12	881-225/10	Trial Plateau, CR, Size 5-6, H = 10 mm	1
13	881-225/11	Trial Plateau, CR, Size 5-6, H = 11 mm	1
14	881-225/12	Trial Plateau, CR, Size 5-6, H = 12 mm	1
15	881-225/14	Trial Plateau, CR, Size 5-6, H = 14 mm	1
16	881-227/10	Trial Plateau, CR, Size 7-8, H = 10 mm	1
17	881-227/11	Trial Plateau, CR, Size 7-8, H = 11 mm	1
18	881-227/12	Trial Plateau, CR, Size 7-8, H = 12 mm	1
19	881-227/14	Trial Plateau, CR, Size 7-8, H = 14 mm	1
20	881-220/43	Shim Trial Plateau, H = +4 mm, Size 3-4	1
21	881-220/45	Shim Trial Plateau, H = +4 mm, Size 5-6	1
22	881-220/47	Shim Trial Plateau, H = +4 mm, Size 7-8	1
23	881-121/30	Femoral Trial, CR, left, Size 3	1
24	881-121/40	Femoral Trial, CR, left, Size 4	1
25	881-121/50	Femoral Trial, CR, left, Size 5	1
26	881-121/60	Femoral Trial, CR, left, Size 6	1
27	881-121/70	Femoral Trial, CR, left, Size 7	1
28	881-121/80	Femoral Trial, CR, left, Size 8	1

881-004/10 PS Instruments & Trials – Grey feet

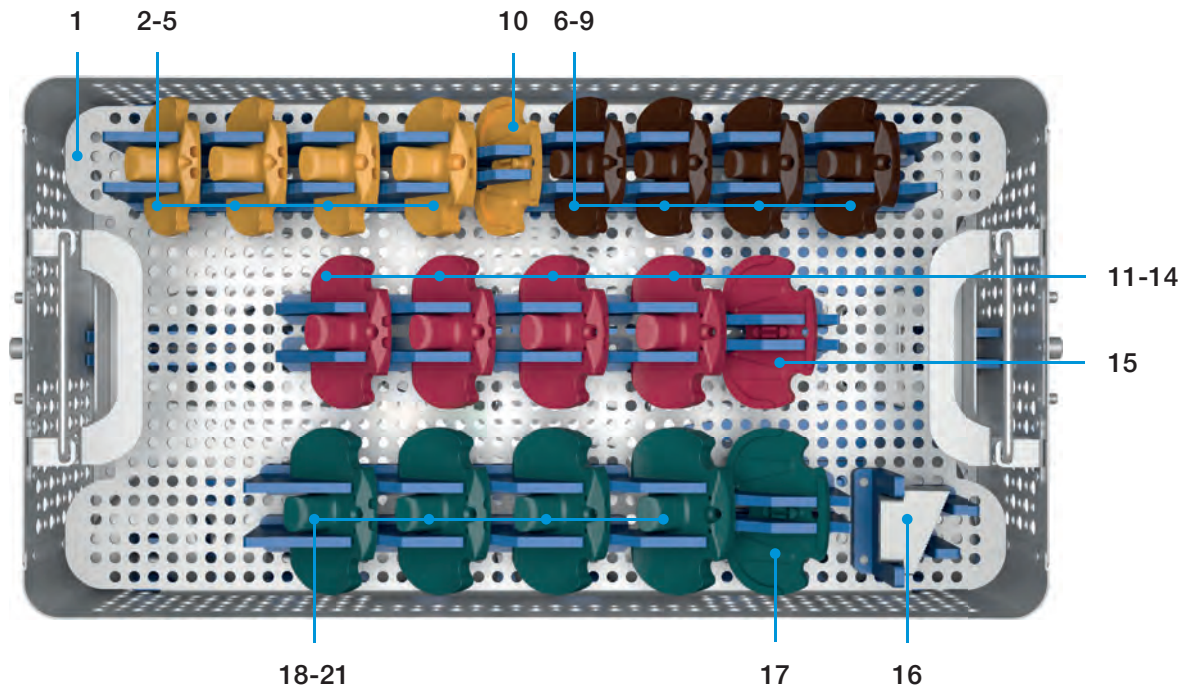

			Qty.
1	881-040/10	LinkSymphoKnee PS Instruments & Trials Tray – Upper Tray	1
2	881-234/10	Trial Plateau, PS, Size 3-4down, H = 10 mm	1
3	881-234/11	Trial Plateau, PS, Size 3-4down, H = 11 mm	1
4	881-234/12	Trial Plateau, PS, Size 3-4down, H = 12 mm	1
5	881-234/14	Trial Plateau, PS, Size 3-4down, H = 13 mm	1
6	881-233/10	Trial Plateau, PS, Size 3-4, H = 10 mm	1
7	881-233/11	Trial Plateau, PS, Size 3-4, H = 11 mm	1
8	881-233/12	Trial Plateau, PS, Size 3-4, H = 12 mm	1
9	881-233/14	Trial Plateau, PS, Size 3-4, H = 14 mm	1
10	881-220/43	Shim, Trial Plateau, H = +4 mm, Size 3-4	1
11	881-235/10	Trial Plateau, PS, Size 5-6, H = 10 mm	1
12	881-235/11	Trial Plateau, PS, Size 5-6, H = 11 mm	1
13	881-235/12	Trial Plateau, PS, Size 5-6, H = 12 mm	1
14	881-235/14	Trial Plateau, PS, Size 5-6, H = 14 mm	1
15	881-220/45	Shim, Trial Plateau, H = +4 mm, Size 5-6	1
16	881-113/02	Femoral PS Box Gauge	1
17	881-220/47	Shim, Trial Plateau, H = +4 mm, Size 7-8	1
18	881-237/10	Trial Plateau, PS, Size 7-8, H = 10 mm	1
19	881-237/11	Trial Plateau, PS, Size 7-8, H = 11 mm	1
20	881-237/12	Trial Plateau, PS, Size 7-8, H = 12 mm	1
21	881-237/14	Trial Plateau, PS, Size 7-8, H = 14 mm	1

881-004/10 PS Instruments & Trials – Grey feet

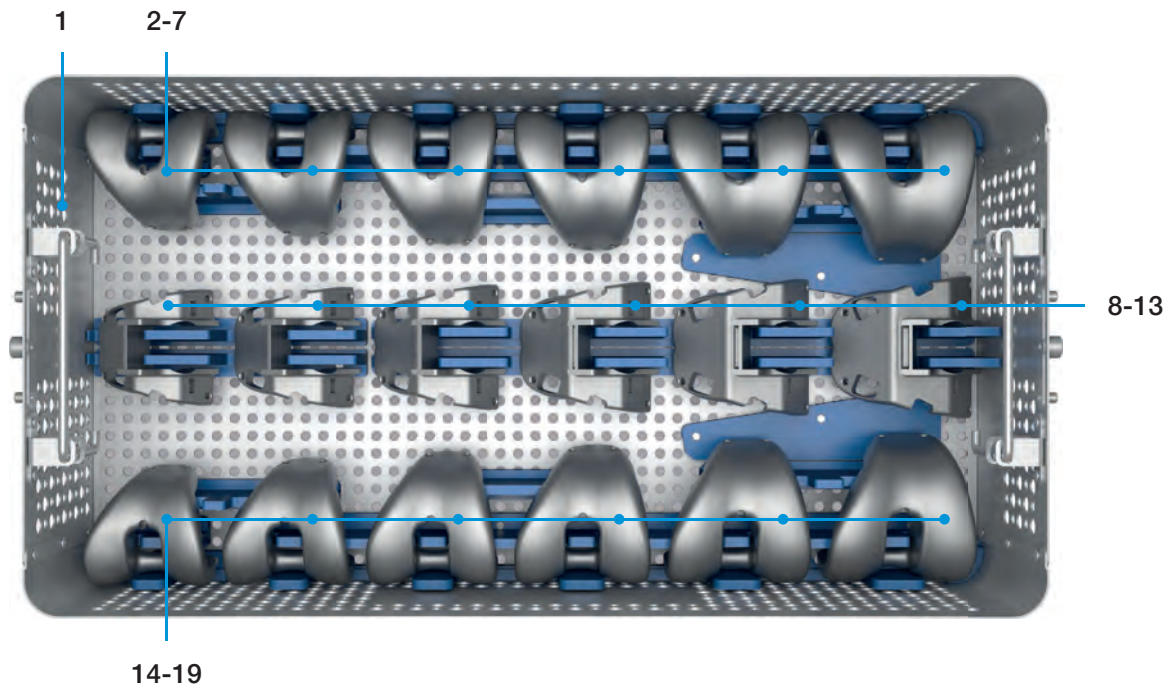

			Qty.
1	881-040/10	LinkSymphoKnee PS Instruments & Trials Tray – Lower Tray	1
2	881-130/30	Femoral Trial, PS, right, Size 3	1
3	881-130/40	Femoral Trial, PS, right, Size 4	1
4	881-130/50	Femoral Trial, PS, right, Size 5	1
5	881-130/60	Femoral Trial, PS, right, Size 6	1
6	881-130/70	Femoral Trial, PS, right, Size 7	1
7	881-130/80	Femoral Trial, PS, right, Size 8	1
8	881-113/30	Femoral PS Box Guide, Size 3	1
9	881-113/40	Femoral PS Box Guide, Size 4	1
10	881-113/50	Femoral PS Box Guide, Size 5	1
11	881-113/60	Femoral PS Box Guide, Size 6	1
12	881-113/70	Femoral PS Box Guide, Size 7	1
13	881-113/80	Femoral PS Box Guide, Size 8	1
14	881-131/30	Femoral Trial, PS, left, Size 3	1
15	881-131/40	Femoral Trial, PS, left, Size 4	1
16	881-131/50	Femoral Trial, PS, left, Size 5	1
17	881-131/60	Femoral Trial, PS, left, Size 6	1
18	881-131/70	Femoral Trial, PS, left, Size 7	1
19	881-131/80	Femoral Trial, PS, left, Size 8	1

881-005/00 PS+ Articulating Surface Trials – Grey feet

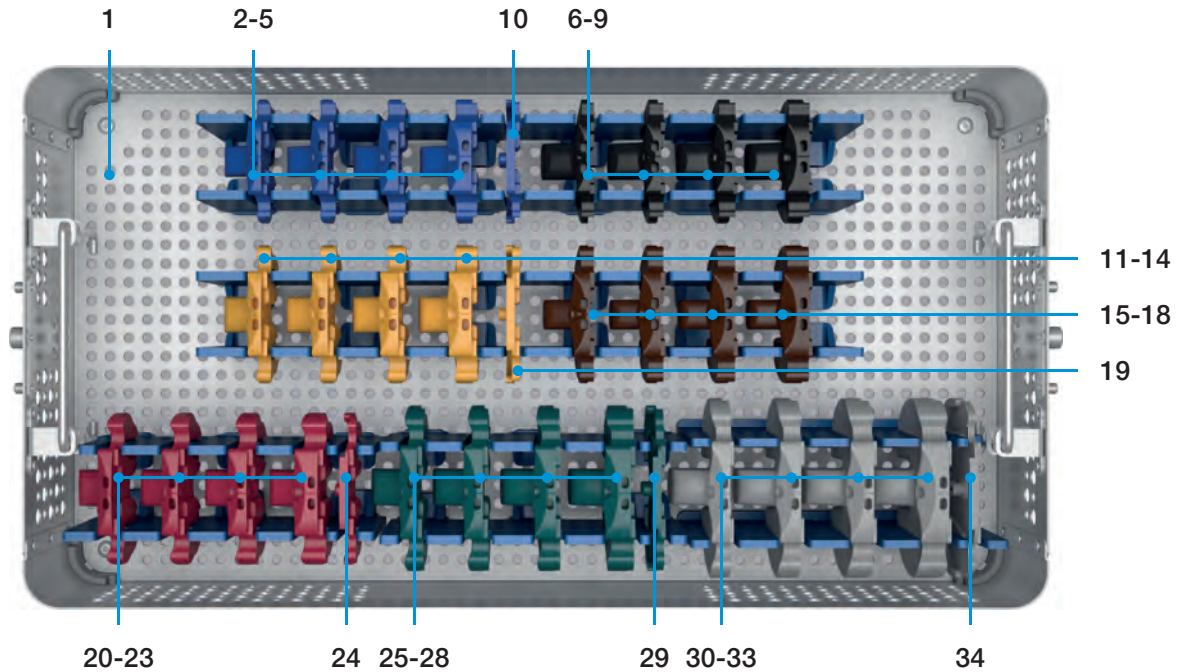

			Qty.
1	881-050/00	LinkSymphoKnee PS+ Articulating Surface Trials Tray	1
2	881-241/10	Trial Plateau, PS+, Size 1-2, H = 10 mm	1
3	881-241/11	Trial Plateau, PS+, Size 1-2, H = 11 mm	1
4	881-241/12	Trial Plateau, PS+, Size 1-2, H = 12 mm	1
5	881-241/14	Trial Plateau, PS+, Size 1-2, H = 14 mm	1
6	881-242/10	Trial Plateau, PS+, Size 1-2up, H = 10 mm	1
7	881-242/11	Trial Plateau, PS+, Size 1-2up, H = 11 mm	1
8	881-242/12	Trial Plateau, PS+, Size 1-2up, H = 12 mm	1
9	881-242/14	Trial Plateau, PS+, Size 1-2up, H = 14 mm	1
10	881-220/41	Shim, Trial Plateau, H = +4 mm, Size 1-2	1
11	881-243/10	Trial Plateau, PS+, Size 3-4, H = 10 mm	1
12	881-243/11	Trial Plateau, PS+, Size 3-4, H = 11 mm	1
13	881-243/12	Trial Plateau, PS+, Size 3-4, H = 12 mm	1
14	881-243/14	Trial Plateau, PS+, Size 3-4, H = 14 mm	1
15	881-244/10	Trial Plateau, PS+, Size 3-4down, H = 10 mm	1
16	881-244/11	Trial Plateau, PS+, Size 3-4down, H = 11 mm	1
17	881-244/12	Trial Plateau, PS+, Size 3-4down, H = 12 mm	1
18	881-244/14	Trial Plateau, PS+, Size 3-4down, H = 14 mm	1
19	881-220/43	Shim, Trial Plateau, H = +4 mm, Size 3-4	1
20	881-245/10	Trial Plateau, PS+, Size 5-6, H = 10 mm	1
21	881-245/11	Trial Plateau, PS+, Size 5-6, H = 11 mm	1
22	881-245/12	Trial Plateau, PS+, Size 5-6, H = 12 mm	1
23	881-245/14	Trial Plateau, PS+, Size 5-6, H = 14 mm	1
24	881-220/45	Shim, Trial Plateau, H = +4 mm, Size 5-6	1
25	881-247/10	Trial Plateau, PS+, Size 7-8, H = 10 mm	1
26	881-247/11	Trial Plateau, PS+, Size 7-8, H = 11 mm	1
27	881-247/12	Trial Plateau, PS+, Size 7-8, H = 12 mm	1
28	881-247/14	Trial Plateau, PS+, Size 7-8, H = 14 mm	1
29	881-220/47	Shim, Trial Plateau, H = +4 mm, Size 7-8	1
30	881-249/10	Trial Plateau, PS+, Size 9-10, H = 10 mm	1
31	881-249/11	Trial Plateau, PS+, Size 9-10, H = 11 mm	1
32	881-249/12	Trial Plateau, PS+, Size 9-10, H = 12 mm	1
33	881-249/14	Trial Plateau, PS+, Size 9-10, H = 14 mm	1
34	881-220/49	Shim, Trial Plateau, H = +4 mm, Size 9-10	1

881-006/10 CCK Instruments & Trials – Yellow feet

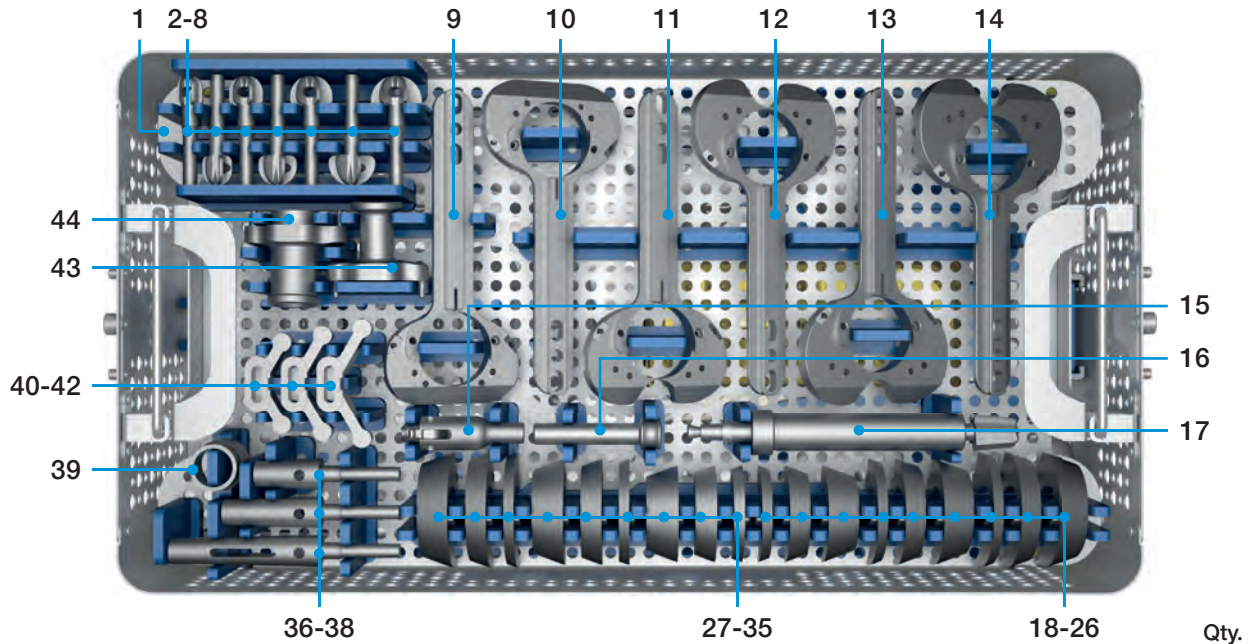

										Qty.
1	881-060/10	LinkSymphoKnee CCK Instruments & Trials Tray – Upper Tray								1
2	151-050/10	50 mm Trial Stem Conical Cemented with Ø 12 mm Centralizer								1
3	151-050/14	50 mm Trial Stem Conical Cemented with Ø 14 mm Centralizer								1
4	151-050/16	50 mm Trial Stem Conical Cemented with Ø 16 mm Centralizer								1
5	151-050/18	50 mm Trial Stem Conical Cemented with Ø 18 mm Centralizer								1
6	151-050/20	50 mm Trial Stem Conical Cemented with Ø 20 mm Centralizer								1
7	151-050/22	50 mm Trial Stem Conical Cemented with Ø 22 mm Centralizer								1
8	151-050/24	50 mm Trial Stem Conical Cemented with Ø 24 mm Centralizer								1
9	881-285/30	Tibial Preparation Plate, CCK, Size 3								1
10	881-285/40	Tibial Preparation Plate, CCK, Size 4								1
11	881-285/50	Tibial Preparation Plate, CCK, Size 5								1
12	881-285/60	Tibial Preparation Plate, CCK, Size 6								1
13	881-285/70	Tibial Preparation Plate, CCK, Size 7								1
14	881-285/80	Tibial Preparation Plate, CCK, Size 8								1
15	151-501/00	Neutral Stem Adapter								1
16	881-070/08	Sleeve, Assignment for Intramedullary Rod, Ø 8 mm								1
17	881-067/17	Tapered Reamer, CCK								1
18	881-333/11	Tibial Trial Augment, Medial-Right/Lateral-Left, Size 3-4, H = 5 mm								1
19	881-333/12	Tibial Trial Augment, Medial-Right/Lateral-Left, Size 3-4, H = 10 mm								1
20	881-333/13	Tibial Trial Augment, Medial-Right/Lateral-Left, Size 3-4, H = 15 mm								1
21	881-335/11	Tibial Trial Augment, Medial-Right/Lateral-Left, Size 5-6, H = 5 mm								1
22	881-335/12	Tibial Trial Augment, Medial-Right/Lateral-Left, Size 5-6, H = 10 mm								1
23	881-335/13	Tibial Trial Augment, Medial-Right/Lateral-Left, Size 5-6, H = 15 mm								1
24	881-337/11	Tibial Trial Augment, Medial-Right/Lateral-Left, Size 7-8, H = 5 mm								1
25	881-337/12	Tibial Trial Augment, Medial-Right/Lateral-Left, Size 7-8, H = 10 mm								1
26	881-337/13	Tibial Trial Augment, Medial-Right/Lateral-Left, Size 7-8, H = 15 mm								1
27	881-333/21	Tibial Trial Augment, Lateral-Right/Medial-Left, Size 3-4, H = 5 mm								1
28	881-333/22	Tibial Trial Augment, Lateral-Right/Medial-Left, Size 3-4, H = 10 mm								1
29	881-333/23	Tibial Trial Augment, Lateral-Right/Medial-Left, Size 3-4, H = 15 mm								1
30	881-335/21	Tibial Trial Augment, Lateral-Right/Medial-Left, Size 5-6, H = 5 mm								1
31	881-335/22	Tibial Trial Augment, Lateral-Right/Medial-Left, Size 5-6, H = 10 mm								1
32	881-335/23	Tibial Trial Augment, Lateral-Right/Medial-Left, Size 5-6, H = 15 mm								1
33	881-337/21	Tibial Trial Augment, Lateral-Right/Medial-Left, Size 7-8, H = 5 mm								1
34	881-337/22	Tibial Trial Augment, Lateral-Right/Medial-Left, Size 7-8, H = 10 mm								1
35	881-337/23	Tibial Trial Augment, Lateral-Right/Medial-Left, Size 7-8, H = 15 mm								1
36	151-080/15	80 mm Trial Stem Conical Cemented, Ø 15 mm								1
37	151-095/15	95 mm Trial Stem Conical Cemented, Ø 15 mm								1
38	151-120/15	120 mm Trial Stem Conical Cemented, Ø 15 mm								1
39	881-065/09	Reamer Stopper, Offset								1
40	881-275/34	Tibial Keel Punch, CCK, Size 3-4								1
41	881-275/56	Tibial Keel Punch, CCK, Size 5-6								1
42	881-275/78	Tibial Keel Punch, CCK, Size 7-8								1
43	881-055/00	Neutral Alignment Guide, CCK, 0 mm offset								1
44	881-065/00	Tibial Reamer Guide, CCK								1

881-006/10 CCK Instruments & Trials – Yellow feet

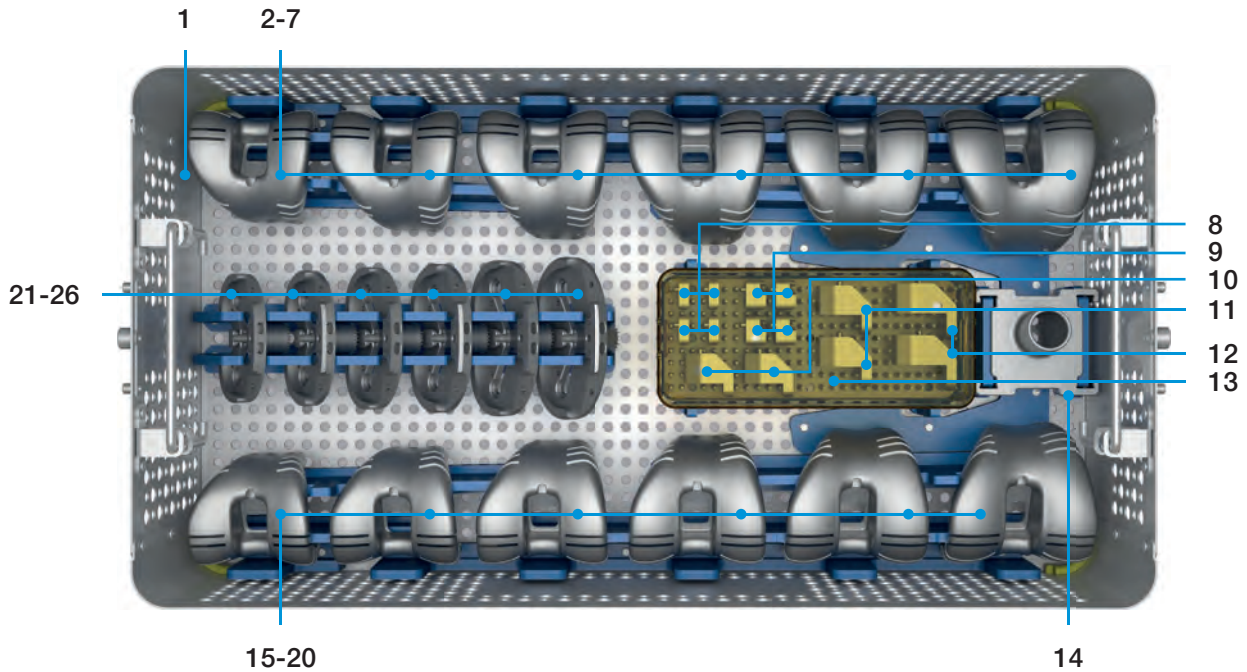

			Qty.
1	881-060/10	LinkSymphoKnee CCK Instruments & Trials Tray – Lower Tray	1
2	881-150/30	Femoral Trial, CCK, right, Size 3	1
3	881-150/40	Femoral Trial, CCK, right, Size 4	1
4	881-150/50	Femoral Trial, CCK, right, Size 5	1
5	881-150/60	Femoral Trial, CCK, right, Size 6	1
6	881-150/70	Femoral Trial, CCK, right, Size 7	1
7	881-150/80	Femoral Trial, CCK, right, Size 8	1
8	881-302/91	Femoral Trial Augment, H = 5 mm	4
9	881-302/92	Femoral Trial Augment, H = 10 mm	4
10	881-323/93	Femoral Trial Augment, L-Shaped, Size 3-4, H = 15 mm	2
11	881-325/93	Femoral Trial Augment, L-Shaped, Size 5-6, H = 15 mm	2
12	881-327/93	Femoral Trial Augment, L-Shaped, Size 7-8, H = 15 mm	2
13	319-603/30	Sterilizing Box, medium high	1
14	881-116/00	Reamer Guide, Femoral Box, CCK	1
15	881-151/30	Femoral Trial, CCK, left, Size 3	1
16	881-151/40	Femoral Trial, CCK, left, Size 4	1
17	881-151/50	Femoral Trial, CCK, left, Size 5	1
18	881-151/60	Femoral Trial, CCK, left, Size 6	1
19	881-151/70	Femoral Trial, CCK, left, Size 7	1
20	881-151/80	Femoral Trial, CCK, left, Size 8	1
21	881-258/30	Tibial Trial Component, CCK, Size 3	1
22	881-258/40	Tibial Trial Component, CCK, Size 4	1
23	881-258/50	Tibial Trial Component, CCK, Size 5	1
24	881-258/60	Tibial Trial Component, CCK, Size 6	1
25	881-258/70	Tibial Trial Component, CCK, Size 7	1
26	881-258/80	Tibial Trial Component, CCK, Size 8	1

881-009/00 Patella Instruments & Trials – Blue feet

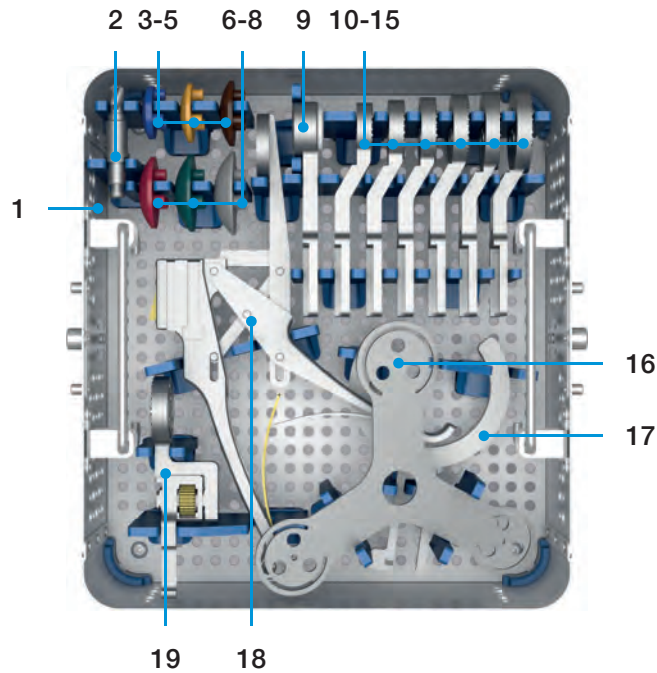

			Qty.
1	881-090/00	LinkSymphoKnee Patella Instruments & Trials Tray	1
2	881-012/00	Universal Drill	1
3	881-501/25	Patella Trial, Ø 25 mm, H = 6 mm	1
4	881-501/28	Patella Trial, Ø 28 mm, H = 6 mm	1
5	881-501/31	Patella Trial, Ø 31 mm, H = 7 mm	1
6	881-501/34	Patella Trial, Ø 34 mm, H = 8 mm	1
7	881-501/37	Patella Trial, Ø 37 mm, H = 9 mm	1
8	881-501/40	Patella Trial, Ø 40 mm, H = 10 mm	1
9	445-904/00	Patella Clamp, Clamp Arm	1
10	881-511/25	Patella Drill Guide, Ø 25 mm	1
11	881-511/28	Patella Drill Guide, Ø 28 mm	1
12	881-511/31	Patella Drill Guide, Ø 31 mm	1
13	881-511/34	Patella Drill Guide, Ø 34 mm	1
14	881-511/37	Patella Drill Guide, Ø 37 mm	1
15	881-511/40	Patella Drill Guide, Ø 40 mm	1
16	881-509/00	Patella Sizing Template	1
17	445-903/00	Patella Clamp, Resection Guide	1
18	445-902/00	Patella Clamp, Handle	1
19	881-500/00	Patella Depth Gauge	1

881-002/00# Femoral/Tibial Instruments Micro-Sizes – Blue feet

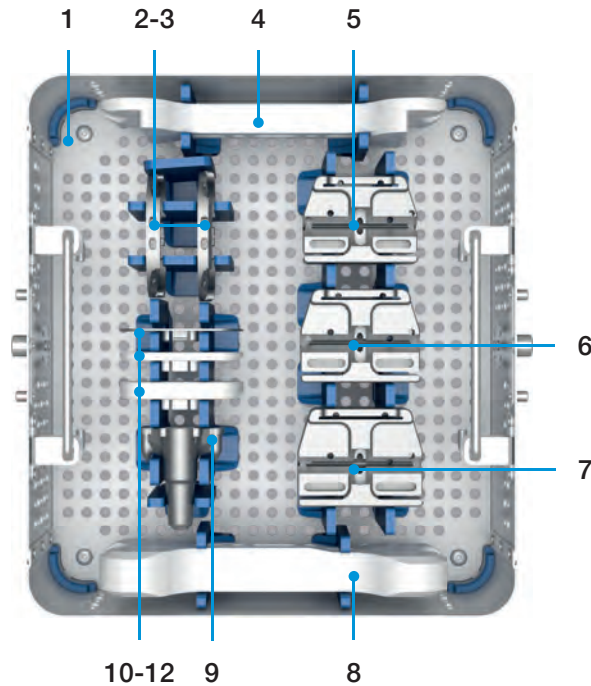

			Qty.
1	881-020/00#	LinkSymphoKnee Femoral/Tibial Instruments Micro-Sizes Tray	1
2	881-283/10#	Fixed Bearing, Tibial Preparation Plate, Size 1	1
3	881-283/20#	Fixed Bearing, Tibial Preparation Plate, Size 2	1
4	881-011/01#	Spacer 4-in-1 Cut, Micro-Sizes, Flexion, H = 10-12 mm	1
5	881-119/00#	Femoral Cutting Block, 4-in-1 Cut, Size 0	1
6	881-119/10#	Femoral Cutting Block, 4-in-1 Cut, Size 1	1
7	881-119/20#	Femoral Cutting Block, 4-in-1 Cut, Size 2	1
8	881-010/01#	Spacer, Micro-Sizes, Flexion/Extension, H = 10-12 mm	1
9	881-272/12#	Tibial Keel Punch, Size 1-2	1
10	881-019/91#	Shim, Spacer, H = 1 mm, Micro-Sizes	1
11	881-019/94#	Shim, Spacer, H = 4 mm, Micro-Sizes	1
12	881-019/98#	Shim, Spacer, H = 8 mm, Micro-Sizes	1

Upon request

881-003/00# CR Instruments & Trials Micro-Sizes – Green feet

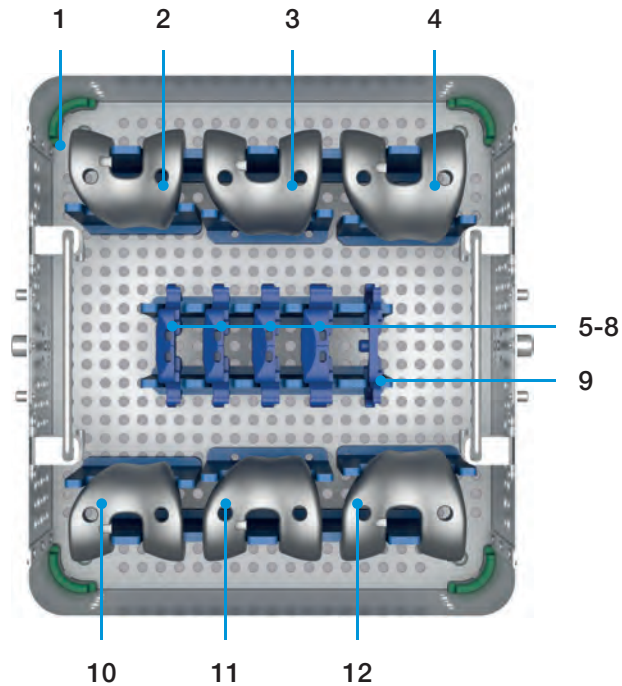

			Qty.
1	881-030/00#	LinkSymphoKnee CR Instruments & Trials Micro-Sizes Tray	1
2	881-120/00#	Femoral Trial, CR, right, Size 0	1
3	881-120/10#	Femoral Trial, CR, right, Size 1	1
4	881-120/20#	Femoral Trial, CR, right, Size 2	1
5	881-221/10#	Trial Plateau, CR, Size 1-2, H = 10 mm	1
6	881-221/11#	Trial Plateau, CR, Size 1-2, H = 11 mm	1
7	881-221/12#	Trial Plateau, CR, Size 1-2, H = 12 mm	1
8	881-221/14#	Trial Plateau, CR, Size 1-2, H = 14 mm	1
9	881-220/41#	Shim, Trial Plateau, H = +4 mm, Size 1-2	1
10	881-121/00#	Femoral Trial, CR, left, Size 0	1
11	881-121/10#	Femoral Trial, CR, left, Size 1	1
12	881-121/20#	Femoral Trial, CR, left, Size 2	1

Upon request

881-004/00# PS Instruments & Trials Micro-Sizes – Grey feet

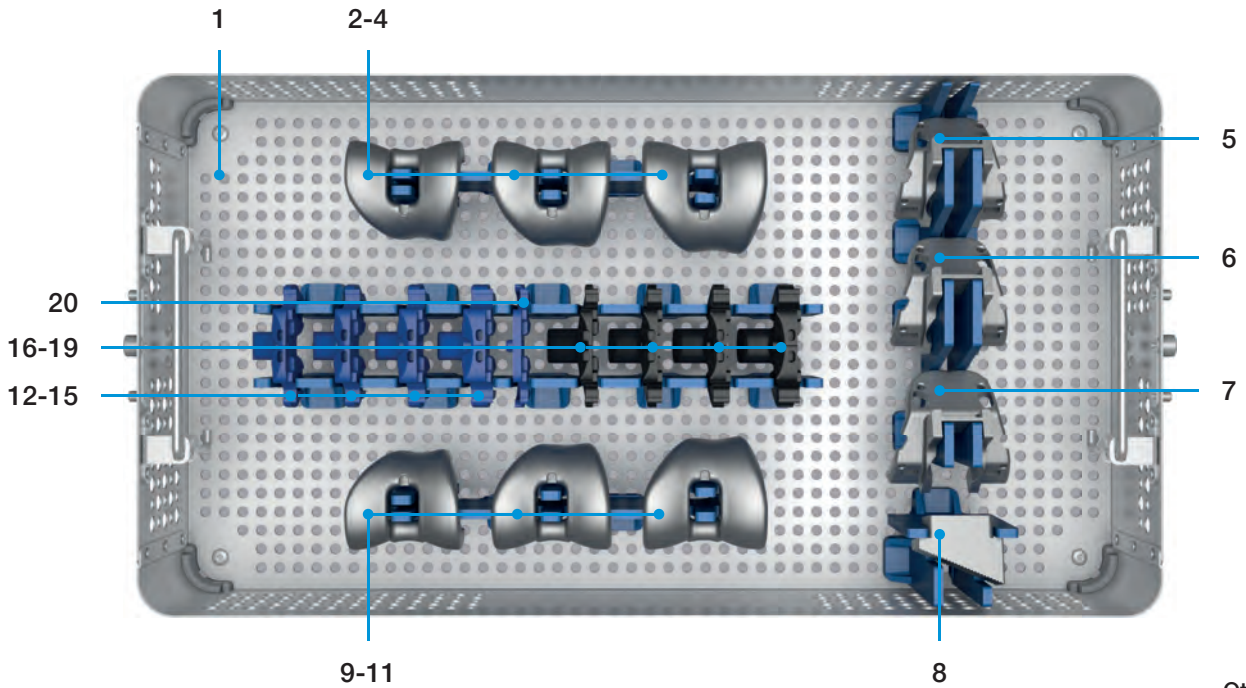

			Qty.
1	881-040/00#	LinkSymphoKnee PS Instruments & Trials Micro-Sizes Tray	1
2	881-130/00#	Femoral Trial, PS, right, Size 0	1
3	881-130/10#	Femoral Trial, PS, right, Size 1	1
4	881-130/20#	Femoral Trial, PS, right, Size 2	1
5	881-113/00#	Femoral PS Box Guide, Size 0	1
6	881-113/10#	Femoral PS Box Guide, Size 1	1
7	881-113/20#	Femoral PS Box Guide, Size 2	1
8	881-113/01#	Femoral PS Box Gauge, micro-sizes	1
9	881-131/00#	Femoral Trial, PS, left, Size 0	1
10	881-131/10#	Femoral Trial, PS, left, Size 1	1
11	881-131/20#	Femoral Trial, PS, left, Size 2	1
12	881-231/10#	Trial Plateau, PS, Size 1-2, H = 10 mm	1
13	881-231/11#	Trial Plateau, PS, Size 1-2, H = 11 mm	1
14	881-231/12#	Trial Plateau, PS, Size 1-2, H = 12 mm	1
15	881-231/14#	Trial Plateau, PS, Size 1-2, H = 14 mm	1
16	881-232/10#	Trial Plateau, PS, Size 1-2up, H = 10 mm	1
17	881-232/11#	Trial Plateau, PS, Size 1-2up, H = 11 mm	1
18	881-232/12#	Trial Plateau, PS, Size 1-2up, H = 12 mm	1
19	881-232/14#	Trial Plateau, PS, Size 1-2up, H = 14 mm	1
20	881-220/41#	Shim, Trial Plateau, H = +4 mm, Size 1-2	1

Upon request

881-006/00# CCK Instruments & Trials Micro-Sizes – Yellow feet

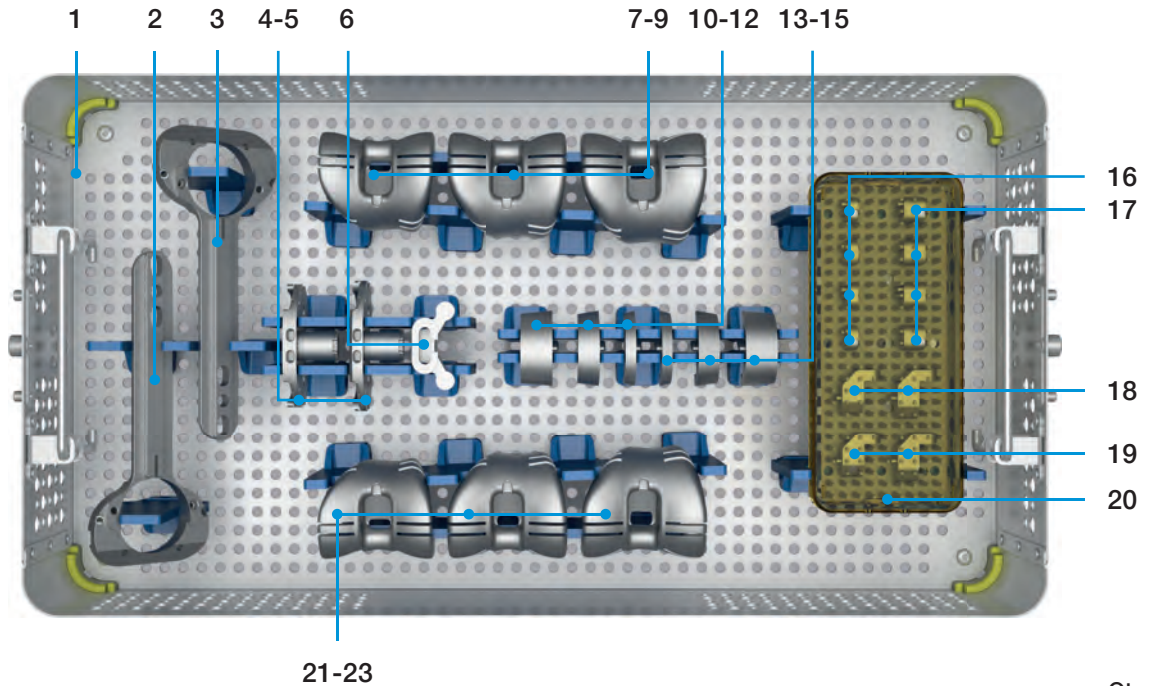

			Qty.
1	881-060/00#	LinkSymphoKnee CCK Instruments & Trials Micro-Sizes Tray	1
2	881-285/10#	Tibial Preparation Plate, CCK, Size 1	1
3	881-285/20#	Tibial Preparation Plate, CCK, Size 2	1
4	881-258/10#	Tibial Trial Component, CCK, Size 1	1
5	881-258/20#	Tibial Trial Component, CCK, Size 2	1
6	881-275/12#	Tibial Keel Punch, CCK, Size 1-2	1
7	881-150/00#	Femoral Trial, CCK, right, Size 0	1
8	881-150/10#	Femoral Trial, CCK, right, Size 1	1
9	881-150/20#	Femoral Trial, CCK, right, Size 2	1
10	881-331/11#	Tibial Trial Augment, Medial-Right/Lateral-Left, Size 1-2, H = 5 mm	1
11	881-331/12#	Tibial Trial Augment, Medial-Right/Lateral-Left, Size 1-2, H = 10 mm	1
12	881-331/13#	Tibial Trial Augment, Medial-Right/Lateral-Left, Size 1-2, H = 15 mm	1
13	881-331/21#	Tibial Trial Augment, Lateral-Right/Medial-Left, Size 1-2, H = 5 mm	1
14	881-331/22#	Tibial Trial Augment, Lateral-Right/Lateral-Left, Size 1-2, H = 10 mm	1
15	881-331/23#	Tibial Trial Augment, Lateral-Right/Lateral-Left, Size 1-2, H = 15 mm	1
16	881-301/91#	Femoral Trial Augment, Micro-Sizes, H = 5 mm	4
17	881-301/92#	Femoral Trial Augment, Micro-Sizes, H = 10 mm	4
18	881-320/92#	Femoral Trial Augment, L-Shaped, Size 0, H = 10 mm	2
19	881-321/92#	Femoral Trial Augment, L-Shaped, Size 1-2, H = 10 mm	2
20	319-603/30#	Sterilizing Box, medium high	1
21	881-151/00#	Femoral Trial, CCK, left, Size 0	1
22	881-151/10#	Femoral Trial, CCK, left, Size 1	1
23	881-151/20#	Femoral Trial, CCK, left, Size 2	1

Upon request

881-002/20# Femoral/Tibial Instruments Macro-Sizes – Blue feet

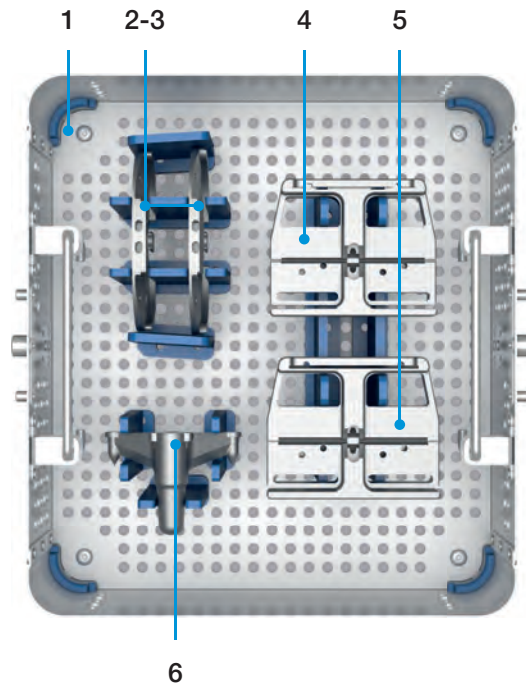

			Qty.
1	881-020/20#	LinkSymphoKnee Femoral/Tibial Instruments Macro-Sizes Tray	1
2	881-283/90#	Fixed Bearing, Tibial Preparation Plate, Size 9	1
3	881-283/X0#	Fixed Bearing, Tibial Preparation Plate, Size 10	1
4	881-119/90#	Femoral Cutting Block, 4-in-1 Cut, Size 9	1
5	881-119/X0#	Femoral Cutting Block, 4-in-1 Cut, Size 10	1
6	881-272/9X#	Tibial Keel Punch, Size 9-10	1

Upon request

881-003/20# CR Instruments & Trials Macro-Sizes – Green feet

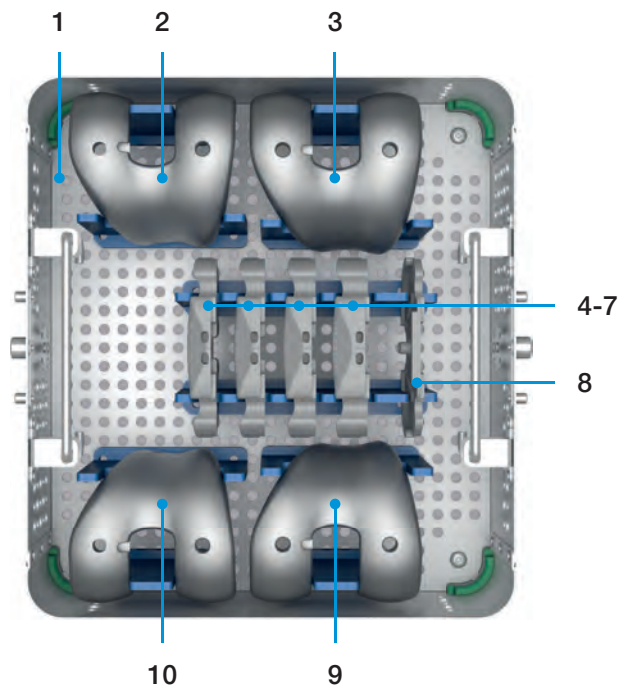

			Qty.
1	881-030/20#	LinkSymphoKnee CR Instruments & Trials Macro-Sizes Tray	1
2	881-120/90#	Femoral Trial, CR, right, Size 9	1
3	881-120/X0#	Femoral Trial, CR, right, Size 10	1
4	881-229/10#	Trial Plateau, CR, Size 9-10, H = 10 mm	1
5	881-229/11#	Trial Plateau, CR, Size 9-10, H = 11 mm	1
6	881-229/12#	Trial Plateau, CR, Size 9-10, H = 12 mm	1
7	881-229/14#	Trial Plateau, CR, Size 9-10, H = 14 mm	1
8	881-220/49#	Shim, Trial Plateau, H = +4 mm, Size 9-10	1
9	881-121/90#	Femoral Trial, CR, left, Size 9	1
10	881-121/X0#	Femoral Trial, CR, left, Size 10	1

Upon request

881-004/20# PS Instruments & Trials Macro-Sizes – Grey feet

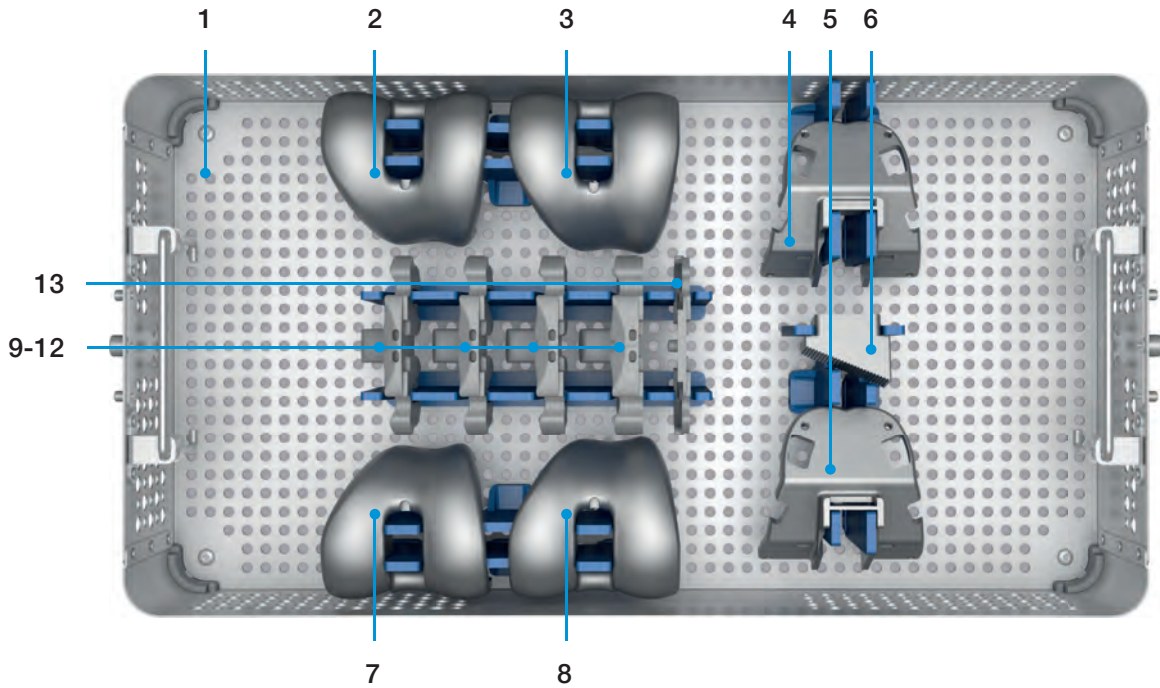

			Qty.
1	881-040/20#	LinkSymphoKnee PS Instruments & Trials Macro-Sizes Tray	1
2	881-130/90#	Femoral Trial, PS, right, Size 9	1
3	881-130/X0#	Femoral Trial, PS, right, Size 10	1
4	881-113/90#	Femoral PS Box Guide, Size 9	1
5	881-113/X0#	Femoral PS Box Guide, Size 10	1
6	881-113/02#	Femoral PS Box Gauge	1
7	881-131/90#	Femoral Trial, PS, left, Size 9	1
8	881-131/X0#	Femoral Trial, PS, left, Size 10	1
9	881-239/10#	Trial Plateau, PS, Size 9-10, H = 10 mm	1
10	881-239/11#	Trial Plateau, PS, Size 9-10, H = 11 mm	1
11	881-239/12#	Trial Plateau, PS, Size 9-10, H = 12 mm	1
12	881-239/14#	Trial Plateau, PS, Size 9-10, H = 14 mm	1
13	881-220/49#	Shim, Trial Plateau, H = +4 mm, Size 9-10	1

Upon request

881-006/2# CCK Instruments & Trials Macro-Sizes – Yellow feet

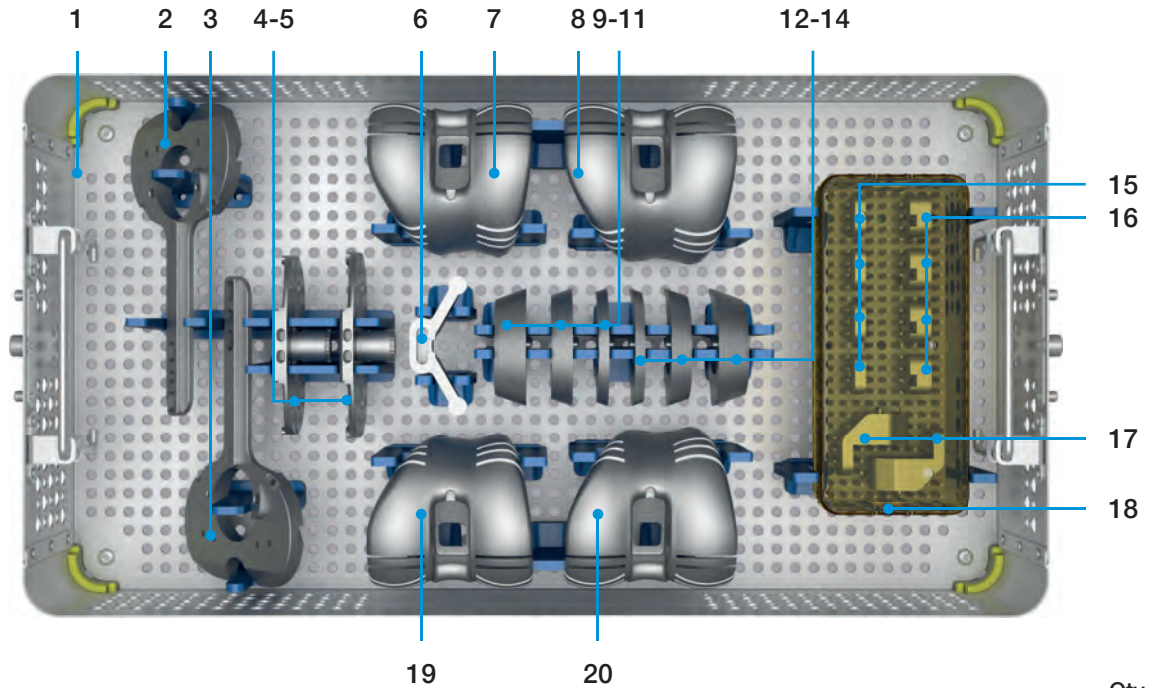

			Qty.
1	881-060/20#	LinkSymphoKnee CCK Instruments & Trials Macro-Sizes Tray	1
2	881-285/90#	Tibial Preparation Plate, CCK, Size 9	1
3	881-285/X0#	Tibial Preparation Plate, CCK, Size 10	1
4	881-258/90#	Tibial Trial Component, CCK, Size 9	1
5	881-258/X0#	Tibial Trial Component, CCK, Size 10	1
6	881-275/9X#	Tibial Keel Punch, CCK, Size 9-10	1
7	881-150/90#	Femoral Trial, CCK, right, Size 9	1
8	881-150/X0#	Femoral Trial, CCK, right, Size 10	1
9	881-339/11#	Tibial Trial Augment, Medial-Right/Lateral-Left, Size 9-10, H = 5 mm	1
10	881-339/12#	Tibial Trial Augment, Medial-Right/Lateral-Left, Size 9-10, H = 10 mm	1
11	881-339/13#	Tibial Trial Augment, Medial-Right/Lateral-Left, Size 9-10, H = 15 mm	1
12	881-339/21#	Tibial Trial Augment, Lateral-Right/Medial-Left, Size 9-10, H = 5 mm	1
13	881-339/22#	Tibial Trial Augment, Lateral-Right/Medial-Left, Size 9-10, H = 10 mm	1
14	881-339/23#	Tibial Trial Augment, Lateral-Right/Medial-Left, Size 9-10, H = 15 mm	1
15	881-303/91#	Femoral Trial Augment, Macro-Sizes, H = 5 mm	4
16	881-303/92#	Femoral Trial Augment, Macro-Sizes, H = 10 mm	4
17	881-329/93#	Femoral Trial Augment, L-Shaped, Size 9-10, H = 15 mm	2
18	319-603/30#	Sterilizing Box, medium high	1
19	881-151/90#	Femoral Trial, CCK, left, Size 9	1
20	881-151/X0#	Femoral Trial, CCK, left, Size 10	1

Upon request

881-003/30# CR Instruments & Trials Wide-Sizes – Green feet

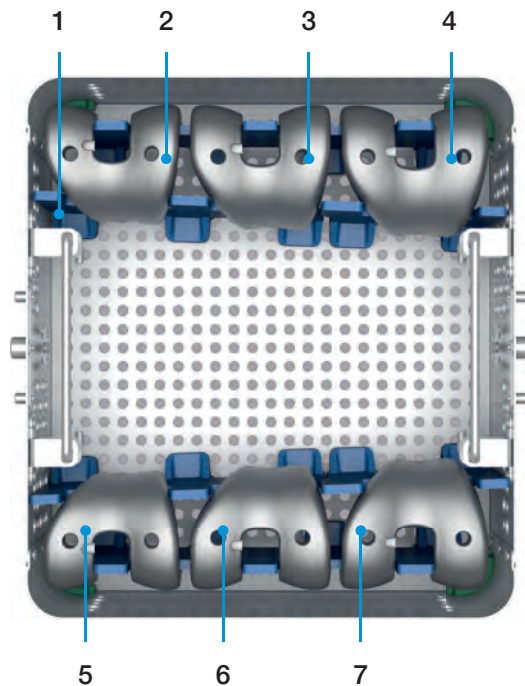

			Qty.
1	881-030/30#	LinkSymphoKnee CR Instruments & Trials Wide-Sizes Tray	1
2	881-120/35#	Femoral Trial, CR, right, Size 3+	1
3	881-120/45#	Femoral Trial, CR, right, Size 4+	1
4	881-120/55#	Femoral Trial, CR, right, Size 5+	1
5	881-121/35#	Femoral Trial, CR, left, Size 3+	1
6	881-121/45#	Femoral Trial, CR, left, Size 4+	1
7	881-121/55#	Femoral Trial, CR, left, Size 5+	1

Upon request

881-004/30# PS Instruments & Trials Wide-Sizes – Grey feet

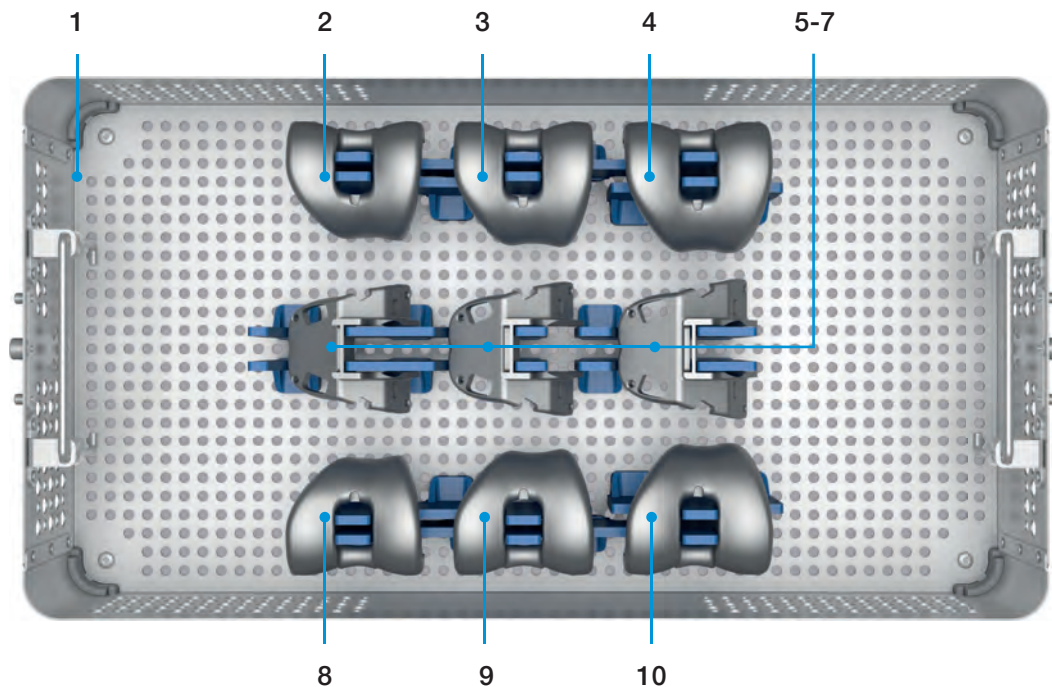

			Qty.
1	881-040/30#	LinkSymphoKnee PS Instruments & Trials Wide-Sizes Tray	1
2	881-130/35#	Femoral Trial, PS, right, Size 3+	1
3	881-130/45#	Femoral Trial, PS, right, Size 4+	1
4	881-130/55#	Femoral Trial, PS, right, Size 5+	1
5	881-113/35#	Femoral PS Box Guide, Size 3+	1
6	881-113/45#	Femoral PS Box Guide, Size 4+	1
7	881-113/55#	Femoral PS Box Guide, Size 5+	1
8	881-131/35#	Femoral Trial, PS, left, Size 3+	1
9	881-131/45#	Femoral Trial, PS, left, Size 4+	1
10	881-131/55#	Femoral Trial, PS, left, Size 5+	1

Upon request

881-006/30# CCK Instruments & Trials Wide-Sizes – Yellow feet

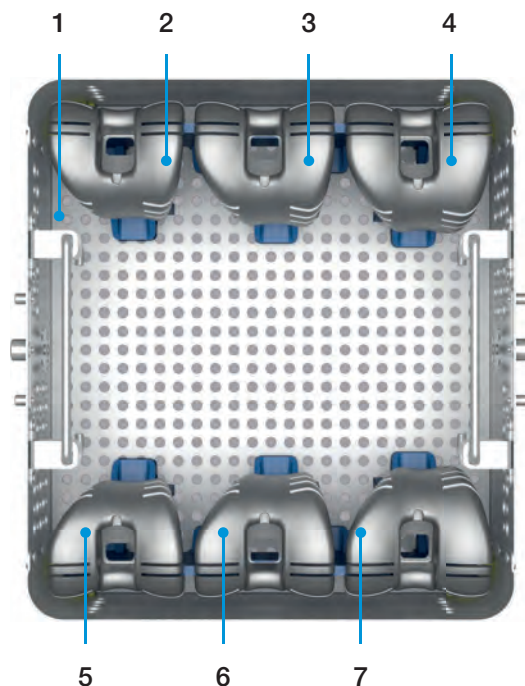

			Qty.
1	881-060/30#	LinkSymphoKnee CCK Instruments & Trials Wide-Sizes Tray	1
2	881-150/35#	Femoral Trial, CCK, right, Size 3+	1
3	881-150/45#	Femoral Trial, CCK, right, Size 4+	1
4	881-150/55#	Femoral Trial, CCK, right, Size 5+	1
5	881-151/35#	Femoral Trial, CCK, left, Size 3+	1
6	881-151/45#	Femoral Trial, CCK, left, Size 4+	1
7	881-151/55#	Femoral Trial, CCK, left, Size 5+	1

Upon request

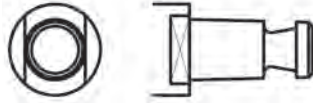

Additional Instruments

Hudson Fitting (B)
Standard tool connection.







Adapter for power tool chuck

Different adapters are available to ensure compatibility to allow various connections:

REF	Attachment	
16-3283/01	Jakobs Fitting (E)	
16-3284/00	AO Fitting (D)	
16-3285/00	Harris Fitting (C)	

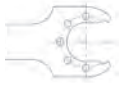

Sawblades,
without offset teeth, 1.24 mm thick

Width (A) 25 mm	Width (A) 13 mm	Fitting	
317-654/10	317-656/10	Synthes	
317-654/11	317-656/11	Aesculap Combi	
317-654/13	317-656/13	Zimmer / Hall Combi	
317-654/14	317-656/14	Stryker System 4	

68-3000
PCL Protector

Instrument for protection of the posterior cruciate ligament when resecting the tibia.



X-ray Templates

110% actual size

REF	X-ray templates for <i>LinkSymphoKnee</i>
881-720/00	To be used with LinkSymphoKnee CR
881-730/00	To be used with LinkSymphoKnee PS
881-750/00	To be used with LinkSymphoKnee CCK

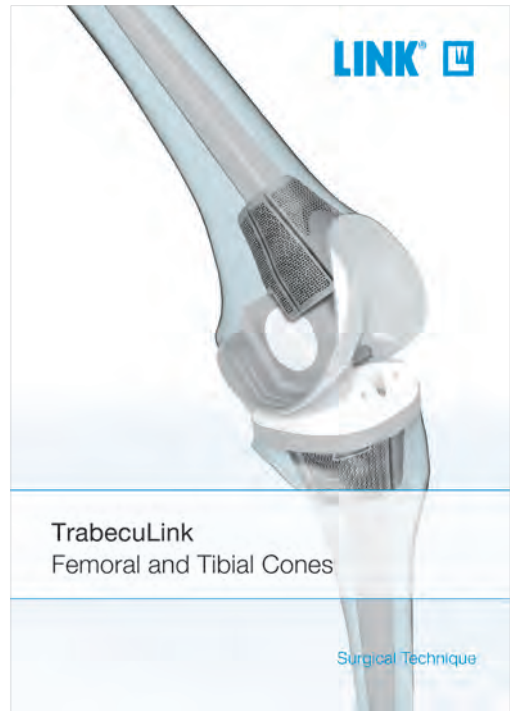

Specified Indications and Contraindications: <i>LinkSymphoKnee</i> System
LinkSymphoKnee Cruciate Retaining Fixed Bearing (CR FB)
Indications:
Any form of uni-, bi- or tricompartmental arthritis of the knee joint (e.g. primary degenerative arthritis, secondary arthritis resulting from rheumatoid arthritis, fracture, post-infection, gout, chondrocalcinosis and others)
Contraindications (absolute):
Acute and chronic infections, local and systemic, insofar as they may compromise the successful implantation
Moderate or severe instability or complete loss of the medial or collateral ligament
Instability or loss of the posterior cruciate ligament
Any bone defect that will result in insufficient implant fixation (based on the fact, that using stems, bone grafts and metal bone substitutes like cones, a minimum bone stock for implant fixation cannot be defined)
Severe insufficiency or loss of extensor mechanism
Contraindications (relative):
Extension deficit >30°
Varus or valgus deformity >30°
Allergy to one of the implant materials
LinkSymphoKnee Posterior Stabilized Fixed Bearing and All-Poly (PS FB and PS All-Poly)
Indications:
Any form of uni-, bi- or tricompartmental arthritis of the knee joint (e.g. primary degenerative arthritis, secondary arthritis resulting from rheumatoid arthritis, fracture, post-infection, gout, chondrocalcinosis and others)
Contraindications (absolute):
Acute and chronic infections, local and systemic, insofar as they may compromise the successful implantation
Moderate or severe instability or complete loss of the medial or collateral ligament
Any bone defect that will result in insufficient implant fixation (based on the fact, that using stems, bone grafts and metal bone substitutes like cones, a minimum bone stock for implant fixation cannot be defined)
Severe insufficiency or loss of extensor mechanism
Contraindications (relative):
Allergy to one of the implant materials
LinkSymphoKnee Posterior Stabilized Plus Fixed Bearing (PS+ FB)
Indications:
Any form of uni-, bi- or tricompartmental arthritis of the knee joint (e.g. primary degenerative arthritis, secondary arthritis resulting from rheumatoid arthritis, fracture, post-infection, gout, chondrocalcinosis and others)
Contraindications (absolute):
Acute and chronic infections, local and systemic, insofar as they may compromise the successful implantation
Severe instability or complete loss of the medial or collateral ligament
Any bone defect that will result in insufficient implant fixation (based on the fact, that using stems, bone grafts and metal bone substitutes like cones, a minimum bone stock for implant fixation cannot be defined)
Severe insufficiency or loss of extensor mechanism
Contraindications (relative):
Situations in which an overall leg alignment will result, that is outside a range of 5° varus or valgus in reference to the mechanical axis. In such a situation the PS+ mechanism may fail over time as a result of the shear forces
Allergy to one of the implant materials
LinkSymphoKnee Condylar Constrained Knee Fixed Bearing (CCK FB)
Indications:
Any form of uni-, bi- or tricompartmental arthritis of the knee joint (e.g. primary degenerative arthritis, secondary arthritis resulting from rheumatoid arthritis, fracture, post-infection, gout, chondrocalcinosis and others)
Contraindications (absolute):
Acute and chronic infections, local and systemic, insofar as they may compromise the successful implantation
Complete loss of the medial or collateral ligament
Any bone defect that will result in insufficient implant fixation (based on the fact, that using stems, bone grafts and metal bone substitutes like cones, a minimum bone stock for implant fixation cannot be defined)
Severe insufficiency or loss of extensor mechanism
Contraindications (relative):
Situations in which an overall leg alignment will result, that is outside a range of 5° varus or valgus in reference to the mechanical axis. In such a situation the CC mechanism may fail over time as a result of the shear forces
Allergy to one of the implant materials

Implants with TiN₂-Coating

In contrast to all other implants an allergy against one of the implant materials is not a contraindication. Otherwise the above mentioned indications and contraindications depending on the design of the TiN₂-coated implants remain the same.

Please note:

These indications/contraindications refer to standard cases. The ultimate decision on whether or not an implant is suitable for a patient must be made by the surgeon based on his/her individual analysis and his/her experience.

Please note the following regarding the use of our implants:

1. Choosing the right implant is very important.

The size and shape of the human bone determines the size and shape of the implant and also limits the load capacity. Implants are not designed to withstand unlimited physical stress. Demands should not exceed normal functional loads.

2. Correct handling of the implant is very important.

Under no circumstances should the shape of a finished implant be altered, as this shortens its life span. Our implants must not be combined with implants from other manufacturers. The instruments indicated in the Surgical Technique must be used to ensure safe implantation of the components.

3. Implants must not be reused.

Implants are supplied sterile and are intended for single use only. Used implants must not be used again.

4. After-treatment is also very important.

The patient must be informed of the limitations of the implant. The load capacity of an implant cannot compare with that of healthy bone!

5. Unless otherwise indicated, implants are supplied in sterile packaging.

Note the following conditions for storage of packaged implants:

- Avoid extreme or sudden changes in temperature.
- Sterile implants in their original, intact protective packaging may be stored in permanent buildings up until the "Use by" date indicated on the packaging.
- They must not be exposed to frost, dampness or direct sunlight, or mechanical damage.
- Implants may be stored in their original packaging for up to 5 years after the date of manufacture. The "Use by" date is indicated on the product label.
- Do not use an implant if the packaging is damaged.

6. Traceability is important.

Please use the documentation stickers provided to ensure traceability.

7. Further information on the material composition is available on request from the manufacturer.

Follow the instructions for use!

Waldemar Link GmbH & Co. KG, Hamburg

All content in this catalog, including text, pictures and data, is protected by law. Every instance of use, whether in part or in whole and which is not permitted by law, is subject to our prior consent. In particular, this applies to the reproduction, editing, translation, publishing, saving, processing, or passing on of content stored in databases or other electronic media and systems, in any manner or form. The information in the catalogs is solely intended to describe the products and does not constitute a guarantee.

The Surgical Technique described has been written to the best of our knowledge and belief, but it does not relieve the surgeon of his/her responsibility to duly consider the particularities of each individual case.

Products shown in this document may not be available in your country. The product availability is subject to the approval and/or registration regulations of the respective country. Please contact Waldemar Link GmbH & Co. KG if you have questions about the availability of LINK products in your country.

Waldemar Link GmbH & Co. KG and/or other corporate affiliated entities own, use or have applied for the following trademarks in many jurisdictions: LINK, BiMobile, SP II, Modell Lubinus, E-Dur, EndoDur, T.O.P. II, BetaCup, CombiCup PF, CombiCup SC, CombiCup R, MobileLink, C.F.P., LCU, SP-CL, LCP, MIT-H, Endo-Model, Endo-Model SL, MP, MEGASYSTEM-C, GEMINI SL, SPAR-K, LCK, HX, TiCaP, X-LINKed, PorAg, LINK PorEx, BiPorEx, PorEx-Z, TrabecuLink, Tilastan, customLINK, RescueSleeve, Stactip, VACUCAST.

Other trademarks and trade names may be used in this document to refer to either the entities claiming the marks and/or names or their products and are the property of their respective owners.



Waldemar Link GmbH & Co. KG

Barkhausenweg 10 · 22339 Hamburg · Germany
Phone +49 40 53995-0 · info@linkhh.de
www.linkorthopaedics.com

LINK[®]

